

LEANPRODUCTS®

Lean manufacturing

V 6.0

Lean Visual Management & Sistema Kanban

Lean Visual & Kanban

ORGATEX®

www.LeanProducts.eu

LEANPRODUCTS®

10 ■

Portadocumenti

Container Labeling

Portadocumenti	14
Finestre magnetiche e tabelle informative	34
Raccoglitori	42
Portadocumenti per contenitori	52
Pinza per pallet	66
Porta Kanban	68
<i>Visual pockets</i>	14
<i>Magnetic Windows and information boards</i>	34
<i>Container labeling</i>	42
<i>Document holder</i>	52
<i>Pallet clamp</i>	66
<i>Kanban</i>	68

114 ■

Segnaletica orizzontale

Floor Markings

LongLife Cleaner, Remover e Primer	120
LongLife segnaletica orizzontale	122
Simboli per delimitazione	140
Schermi protettivi	146
Simboli classificazione	152
Simboli HD	158
Modul	162
LongLife Cold Performance	166
Proiettore e simboli eOX-Spot	168
<i>LongLife Cleaner, Remover and Primer</i>	120
<i>LongLife floor marking tape</i>	122
<i>LongLife symbols</i>	140
<i>Clear View floor frames</i>	146
<i>Classification symbols</i>	152
<i>HD symbols</i>	158
<i>Modul</i>	162
<i>LongLife Cold Performance</i>	166
<i>eOX- Spot</i>	168

78 ■

Identificazione Scaffalature

Storage Labeling

Porta etichette per tubolari	80
Porta etichette magnetici e adesivi	82
Etichette e nastri magnetici	102
Flexschild	108
Cartoncini	110
<i>Rounded Label Holder</i>	80
<i>Label Holders magnetic / self-adhesive stripes</i>	82
<i>Magnetic signs and tapes</i>	102
<i>Flexschild</i>	108
<i>Carboards</i>	110

176 ■

Cornici e tabelle informative

Hanging signs

Cornici Serie 100 / 200	180
Accessori Serie 100	182
Accessori Serie 200	184
Accessori comuni	186
Sistema a sospensione 5S	188
Tabelle informative in alluminio	190
<i>Hanging Signs Series 100 / 200</i>	180
<i>Accessories Serie 100</i>	182
<i>Accessories Serie 200</i>	184
<i>Accessories Series 100 / 200</i>	186
<i>5S-Suspension</i>	188
<i>Aluminium Snap Frames</i>	190

226 ■

[Sistema Kanban](#)

Kanban System

Starter Kit Kanban	198
Systembox e accessori	200
Systembox A4 e accessori	204
Cardplan e accessori	208
Cassette posta Kanban	214
Cartella portadocumenti	220
Cartella Primus	222
<i>Starter Set Kanban</i>	<i>198</i>
<i>Systembox & accessories</i>	<i>200</i>
<i>A4 Systembox & accessories</i>	<i>204</i>
<i>Cardplan & accessories</i>	<i>208</i>
<i>Kanban letterbox</i>	<i>214</i>
<i>Work document DIN A4</i>	<i>220</i>
<i>Primus Work station enveloper</i>	<i>222</i>

226 ■

[Lavagne e accessori](#)

Visual Boards

Lean Factory Corner	228
Lavagne informative	232
Lavagne informative in GF	236
Lean Cube	240
Lean Cube in GF	242
Totem	244
Lavagne Personalizzate	246
Accessori	248
<i>Lean Factory Corner</i>	<i>228</i>
<i>Visual Boards</i>	<i>232</i>
<i>GF Visual Boards</i>	<i>236</i>
<i>Lean Cube</i>	<i>240</i>
<i>GF Lean Cube</i>	<i>242</i>
<i>Stop Sign</i>	<i>244</i>
<i>Customizable Boards</i>	<i>246</i>
<i>Accessories</i>	<i>248</i>

254 ■

[Prodotti ESD](#)

ESD Products

Prodotti ESD	255
<i>Prodotti ESD</i>	<i>255</i>

Soluzioni per l'intralogistica

eOX- For the digitally connected intralogistics

Soluzioni Smart per il
futuro della intralogistica

Qualità consolidata e tecnologicamente avanzata. I nostri prodotti ottimizzano il flusso di materiale e l'intralogistica per l'Industria 4.0. Nascono così soluzioni logistiche che permettono di entrare gradualmente nel mondo dell'intralogistica integrata.

La nostra visione: il futuro della logistica di magazzino è connesso.

L'Industria 4.0 si riferisce alla prossima grande rivoluzione industriale: in futuro, le macchine e i componenti tecnici non staranno più da soli, ma saranno connessi digitalmente, in modo intelligente. L'Internet of Things (IoT) consente di comunicare tra loro tramite Internet e influenzarsi a vicenda in modo significativo.

I componenti intralogistici, come SCL, piattaforme di sollevamento o persino un'intera stazione FiFo, possono essere collegati tra loro secondo necessità. In questo modo, fasi di lavoro precedentemente isolate possono essere combinate e coordinate.

Established quality, but digitally advanced. Our products optimize material flow and intralogistics regarding Industry 4.0. This creates logistic solutions that allow you to enter the world of integrated intralogistics gradually.

Our vision:

The future of warehouse logistics is connected.

Industry 4.0 refers to the next great industrial revolution: in the future, machine and technical components will no longer stand on their own, they will be digitally connected - in a smart way. The Internet of Things (IoT) allows them to communicate with each other via the Internet and influence each other in a meaningful way. This means that intralogistics components, such as SCLs, lifting platforms or even an entire FiFo station, can be linked together as required.

In this way, formerly isolated work stages can be combined and coordinated with each other.

Il risultato è un flusso di materiale integrato che offre numerosi vantaggi:

- Molte fasi di lavoro non devono essere eseguite manualmente
- Notevole risparmio economico

I processi possono essere combinati in modo efficiente tra loro.

Numerose opzioni di pianificazione: configura singolarmente i componenti associati.

Condizioni di lavoro semplificate per i dipendenti. Le soluzioni automatizzate riducono il numero delle fasi di lavoro.

Nostra promessa: come vostro partner, siamo sempre dalla vostra parte.

LeanProducts srl vuole supportarvi con i suoi prodotti per promuovere in modo sostenibile la digitalizzazione dei vostri processi di magazzino. Essere presenti sul mercato da molti anni è un vantaggio. Sappiamo esattamente quali sono le esigenze individuali dei nostri clienti, eppure non perdiamo mai di vista il quadro generale: un mondo di prodotti in cui tutte le soluzioni sono interconnesse in modo intelligente.

The result is a integrated material flow that provides numerous advantages:

- Many work stages don't have to be carried out manually.

Significant cost saving:

Processes can be efficiently combined with each other plenty of planning options: configured the associate components individually.

Simplified working conditions for your employees.

Automated solutions reduce the number of work stages

Our promise:

As your partner, we are always on your side.

We at Leanproducts srl want to support you with its products to promote the digitalization of your warehouse processes. Being present on the market for many years is an advantage. We know exactly what our customers' individual needs are and yet we never lose sight of the big picture: a product world in which all solutions are intelligently interconnected.

Smart solutions for digitally
connected intralogistics

Lean Factory Corner

Pag. 228
page

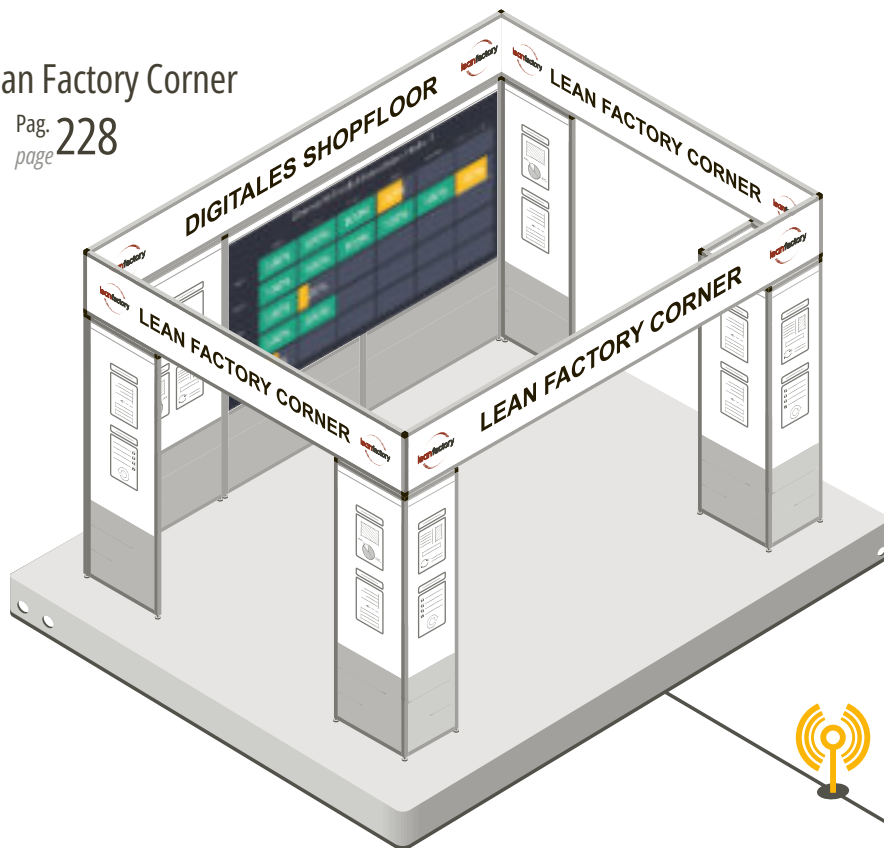

eOX-Spot

Pag. 168
page

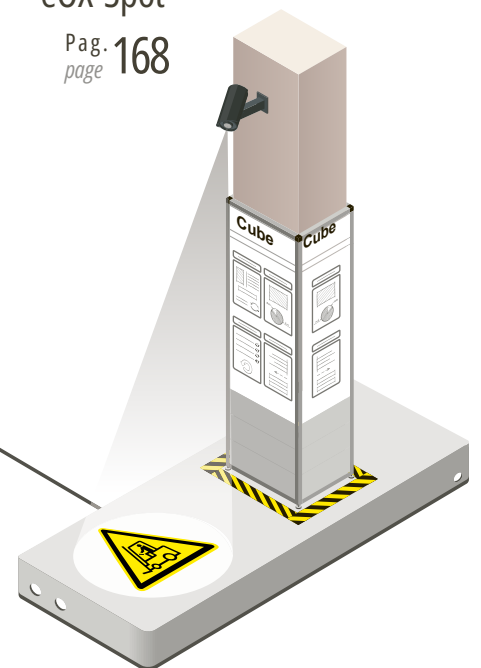

Scopri cosa c'è dentro con uno sguardo: le nostre soluzioni per un'etichettatura comoda e chiara dei contenitori

See what's inside with a glance: our solutions for convenient and clear container labeling

Portadocumenti Container Labeling

L'etichettatura chiara e univoca di tutti i contenitori è un requisito fondamentale per processi efficienti nelle aziende. Che si tratti di Eurobox, scatole di plastica, scatole in rete, KLT, GLT o altre forme di contenitori, rendiamo disponibile sempre la soluzione migliore. È possibile un'etichettatura temporanea o permanente, per soddisfare le esigenze individuali della vostra azienda.

Offriamo un'ampia varietà di soluzioni per identificare i contenitori con materiali e forme diverse: alcuni dei contenitori più comunemente utilizzati dispongono già di moduli di inserimento che possono essere utilizzati per l'etichettatura, ad esempio contenitori KLT o EURO. Portaetichette e portadocumenti in vari design. Offriamo anche soluzioni per le numerose varianti di contenitori senza moduli di inserimento esistenti. Se, ad esempio, non ci sono superfici adatte per il fissaggio i nostri portadocumenti per sospensione sono l'ideale. Offriamo una vasta gamma di opzioni di fissaggio, che possono essere utilizzate per montarle su quasi tutte le superfici.

Basic requirement for efficient processes in businesses: the clear and unambiguous labeling of all containers. Whether it is a eurobox, plastic box, mesh box, KLT, GLT or other container shapes: we always offers the right solution.

Temporary or permanent labeling is possible to match the individual requirements of your company
We offer a wide variety of container shapes and materials: Some of the most commonly used containers already have insert modules that can be used for labeling, e.g. KLT containers or euroboxes. For this we offer custom-made label holders and card pockets in various designs. But we also offer solutions for the numerous container variants without existing insert modules. If there are e.g. no suitable surfaces for attachment, our high-quality processed pockets for hanging are ideal.

Per contenitori in metallo vengono utilizzati i nostri portadocumenti magnetici. Anche i contenitori in plastica, legno o vetro vengono contrassegnati in modo perfetto e sicuro con le nostre buste adesive. Qualunque sia la variante di contenitore che utilizzi, con noi troverai sempre la soluzione giusta per un'etichettatura comoda, efficiente e chiara.

We offer a wide range of options in order to attach the pockets, which can be used to mount them onto almost any surface. If your containers are made out of metal, our magnetic pockets or our magnetic document holders are used. Containers made out of plastic, wood or glass are also marked perfectly and safely with our self-adhesive pockets. Which ever container variant you use - with us you will always find the right solution for convenient, efficient and clear labelin.



Portadocumenti adesivi

Visual Pockets

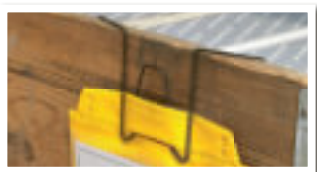

Portadocumenti per sospensione

Mounting Options



Pinze per pallet

Pallet Clamp

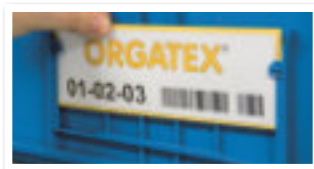

Portadocumenti per cassette KLT

Covers for integrated Card Pockets

Portadocumenti

Infographic Visual Pockets

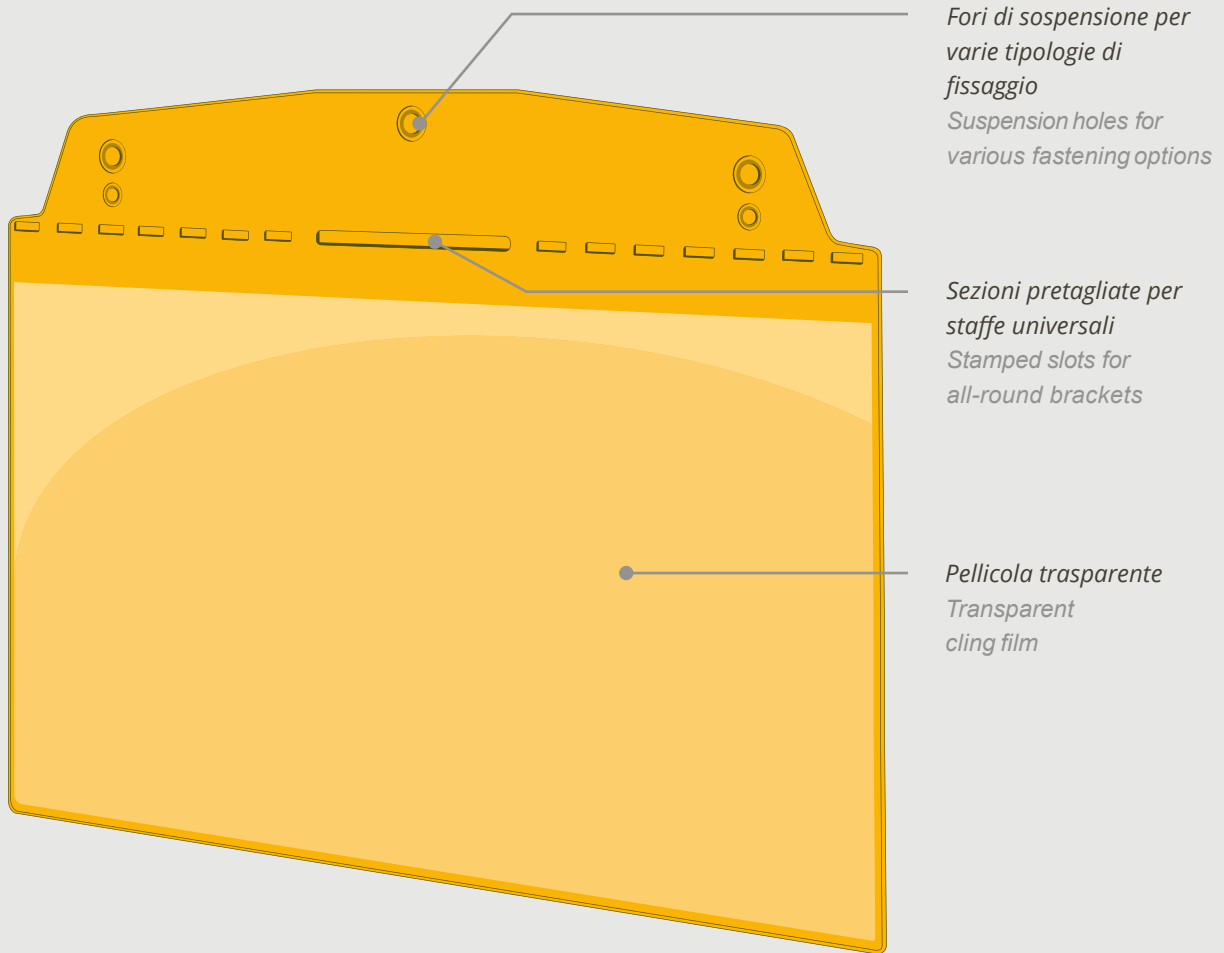

Applicabile a ogni contenitore
Suitable for all containers



Per etichettature rimovibili e permanenti
For flexible or Permanent labeling

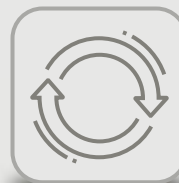

Diverse opzioni di fissaggio
Various attachment options

ORGATEX®

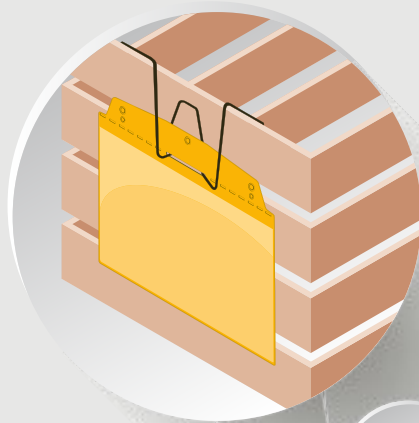

Diverse soluzioni di fissaggio

Grazie all'ampia gamma di opzioni di fissaggio e ai nostri numerosi ed esclusivi accessori è possibile etichettare quasi ogni tipo di contenitore.

For hanging / overhanging

Thanks to the wide range of attachment options and our extensive and unique accessories, almost every type of container can be labeled.

DIN

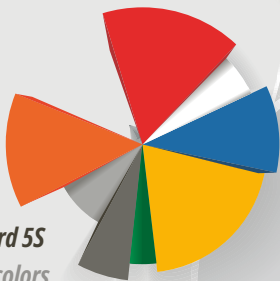

Colori Standard 5S
Standard 5S colors

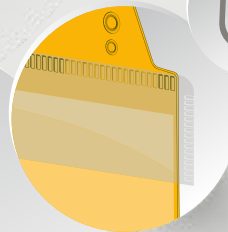

Chiusura

Previene il danneggiamento e la contaminazione.

Protective flap

Prevent contamination of the coverings.

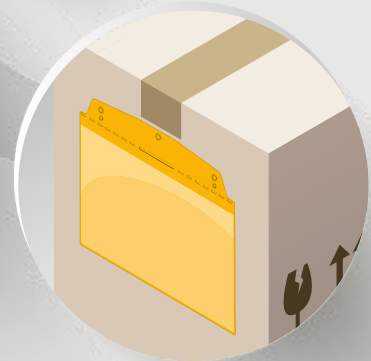

Continuous further development



Magnetico / Super-magnetico

I nostri portadocumenti sono adatti per etichettare scatole reticolari, contenitori metallici o macchine. Aderiscono a tutte le superfici ferrose, sono antiscivolo e si posizionano rapidamente in altri punti.

Magnetic / super-magnetic

Our magnetic visual pockets are suitable for labeling lattice boxes and metal containers or machines. Our visual pockets adhere to all ferrous surfaces, are non-slip and quickly positioned in other places.

Adesivi

Il forte adesivo garantisce una presa sicura anche su superfici irregolari. Che si tratti di metallo, legno, plastica o vetro, la tasca aderisce saldamente anche se sottoposta a forti vibrazioni.

Self-adhesive

The strong adhesive ensures a secure hold even on uneven surfaces. Regardless whether it is metal, wood, plastic or glass, the pocket adheres securely. Even when subjected to strong vibrations.

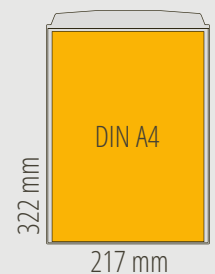
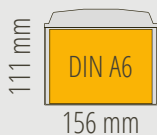

Portadocumenti

Hanging Visual Pockets

Portadocumenti per sospensione in plastica PVC resistente. La parte frontale trasparente permette la lettura dei documenti senza doverli togliere dal portadocumenti stesso. In caso non ci sia un posto apposito per collocare portadocumenti oppure sia necessario un diverso sistema di fissaggio, questa è la soluzione ottimale. I 5 fori e la fessura orizzontale offrono varie possibilità di aggancio.

Document holder for suspension in resistant PVC plastic. The transparent front allows documents to be read without having to remove them from the document holder itself. In case there is no specific place to place document holders or a different fixing system is needed, this is the optimal solution. The 5 holes and the horizontal slot offer various hooking possibilities.

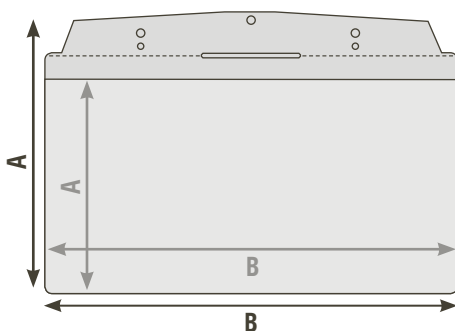

Formati DIN e misure esterne (mm) / interne (mm)

Existing formats in mm outer dimensions (mm) / inner dimensions (mm)

	1/3	A7 orizz. A7 landsc.	A6 orizz. A6 landsc.	A5 orizz. A5 landsc.	A5 vert. A5 portr.	A4 orizz. A4 landsc.	A4 vert. A4 portr.
A	160 / 108	112 / 70	159 / 111	205 / 152	264 / 217	268 / 217	335 / 328
B	230 / 225	115 / 112	159 / 156	230 / 225	160 / 153	325 / 322	229 / 225

ORGATEX®



Portadocumenti per sospensione e sistemi di sospensione

Hanging Visual Pockets, Mounting Options

Versione standard / Standard Design

	Formato Format	Cod. Item-No.	+ Colore	Confezione Pack
			+ Color	
	DIN A7 orizz. / landsc.	SD011-	01 02 03 04 05 06 07 08 20	50 pezzi / pieces
	DIN A6 orizz. / landsc.	SD012-	01 02 03 04 05 06 07 08 20	50 pezzi / pieces
	1/3 DIN	SD016-	01 02 03 04 05 06 07 08 20	50 pezzi / pieces
	DIN A5 orizz. / landsc.	SD013-	01 02 03 04 05 06 07 08 20	50 pezzi / pieces
	DIN A5 vert. / portr.	SD015-	01 02 03 04 05 06 07 08 20	50 pezzi / pieces
	DIN A4 vert. / portr.	SD018-	01 02 03 04 05 06 07 08 20	50 pezzi / pieces
	DIN A4 orizz. / landsc.	SD020-	01 02 03 04 05 06 07 08 20	50 pezzi / pieces



Versione speciale con chiusura / With Protective Flap

	Formato Format	Cod. Item-No.	+ Colore	Confezione Pack
			+ Color	
	DIN A5 orizz. / landsc.	SD014-	01 02 03 04 05 06 07 08 20	50 pezzi / pieces
	DIN A4 vert. / portr.	SD019-	01 02 03 04 05 06 07 08 20	50 pezzi / pieces
	DIN A4 orizz. / landsc.	SD021-	01 02 03 04 05 06 07 08 20	50 pezzi / pieces



Supporto Universale (prodotto brevettato) / Universal Clamp (patent protected)

	Cod. Item-No.	Confezione Pack	
 	KTB3000	50 pezzi / pieces	 <p>• Filo metallico ricoperto in plastica nera con spigoli arrotondati. Il sistema universale di sospensione per i portadocumenti si inserisce in maniera veloce nella fessura orizzontale e può essere utilizzato per contenitori con spessore fino a 40 mm.</p> <p>Non compatibile con:</p> <ul style="list-style-type: none"> - Versione speciale con chiusura - DIN A7, DIN A4 orizz. <p><i>This patented Universal Clamp quickly inserts into our visualpockets through the slot in the header section. Made for skeleton boxes and/or containers up to 40 mm thick.</i></p> <p>May not be used with:</p> <ul style="list-style-type: none"> - With Protective Flap - DIN A7, DIN A4 landsc.

Staffa a Muro / Wall Mounting Bracket

	Cod. Item-No.	Confezione Pack	
 	WDH1	5 pezzi / pieces	<p>Staffa a muro con 2 fori di fissaggio per posizionare i portadocumenti non utilizzati.</p> <p>Dimensioni (LxHxP): 210 x 25 x 60 mm.</p> <p><i>Wall Mounting Bracket for Visual Pockets, hanging. Storage possibility for Visual Pockets not currently in use. Dimensions (WxHxD): 210 x 25 x 60 mm.</i></p>

Staffa Speciale / Special Retaining Clamp

		Cod. Item-No.	Confezione Pack
		MA2000	50 pezzi / pieces
		<p>Filo metallico ricoperto con plastica nera e spigoli arrotondati. Adatto per essere inserito tra cartoni, ceste in metallo, ecc. . Dimensioni (LxH): 320 x 100 mm. Particolarmente adatto per DIN A4 orizz.</p> <p>Non compatibile:</p> <ul style="list-style-type: none"> - DIN A6 orizz. - DIN A5 vert. 	

Staffa Speciale / Mini Special Retaining Clamp

		Cod. Item-No.	Confezione Pack
		MA2080	50 pezzi / pieces
		<p>Filo metallico ricoperto con plastica nera e spigoli arrotondati. Adatto per essere inserito tra cartoni, ceste in metallo, ecc. Dimensioni (LxH): 230 x 80 mm</p> <p>Compatibile con:</p> <ul style="list-style-type: none"> - DIN A5 vert. - DIN A6 orizz. - DIN A5 orizz. 	

Ancoraggio / Container Clamp

		Cod. Item-No.	Confezione Pack
		MA2090	50 Pezzi / pieces
		<p>Filo metallico ricoperto con plastica nera e spigoli arrotondati. Prodotto raccomandato per contenitori con spessore fino a 20 mm. Dimensioni (LxHxP): 170 x 65 x 21 mm.</p> <p>Non compatibile con:</p> <ul style="list-style-type: none"> - DIN A7 orizz. - DIN A6 orizz. - DIN A5 vert. 	

Ancoraggio / Container Clamp

		Cod. Item-No.	Confezione Pack
		MA2100	50 pezzi / pieces
		<p>Filo metallico ricoperto con plastica nera e spigoli arrotondati. Prodotto raccomandato per contenitori con spessore fino a 50 mm. Dimensioni (LxHxP): 170 x 65 x 45 mm</p> <p>Non compatibile con:</p> <ul style="list-style-type: none"> - DIN A7 orizz. - DIN A6 orizz. - DIN A5 vert. 	

Soluzioni per sospensione

Mounting Options

Ancoraggio a U (prodotto brevettato) / Large U-Clamp (patent protected)



Cod.
Item-No.

Confezione
Pack

MA2030

50 pezzi / pieces

L'ancoraggio a U è un prodotto universale. Si può utilizzare su svariati contenitori, ceste in metallo, pellicole protettive, ecc. Dimensioni (LxH): 28 x 55 mm

For attaching pockets / covers to all types of skeleton boxes. The special bend allows easy removal. Dimensions (WxH): 28 x 55 mm

Ancoraggio a U / Small U-Clamp

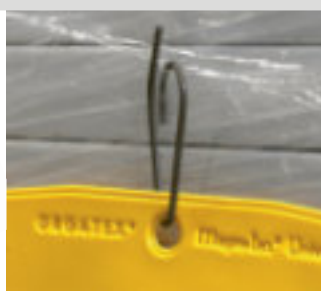

Cod.
Item-No.

Confezione
Pack

MA2020

50 pezzi / pieces

L'ancoraggio a U è un prodotto universale. Si può utilizzare su svariati contenitori, ceste in metallo, pellicole protettive, ecc. Dimensioni (LxH): 15 x 38 mm

For inserting into cardboard containers, plastic wrapping and other types of outer Packaging and use with smaller pocket formats (DIN A7/DIN A6). Dimensions (WxH): 15 x 38 mm

Pinze in metallo / Steel Clip



Cod.
Item-No.

Confezione
Pack

MA2070

50 pezzi / pieces

Pinze in metallo lunghe 35 mm con punta ricoperta in gomma. Indicate per una veloce applicazione su diversi contenitori. Apertura massima 17 mm.

In order to attach Visual Pockets to plastic boxes, rods, wood, cardboard, etc. The Steel Clip has a range of 17 mm and non-slip rubber ends on the grippers for protection and support. Length: 35 mm

Chiodi di plastica / Plastic Clip



Cod.
Item-No.

Confezione
Pack

MA2060

50 pezzi / pieces

Chiodi in plastica per forare cartoni, nastro estensibile, ecc. e permettere la sospensione dei portadocumenti. Lunghezza 12 mm.

The Plastic Clip can be inserted into soft materials such as cardboard boxes, foil, plastic bags, textiles, etc. Length: 12 mm

Gancio gripper / Gripper



Cod.
Item-No.

Confezione
Pack

KAN-Gripper

100 pezzi / pieces

Gancio in plastica, ideale per sospendere i portadocumenti su ceste metalliche.
Dimensioni (LxH): 12 x 20 mm

Plastic hook, ideal for hanging document holders on metal baskets.
Dimensions (WxH): 12 x 20 mm

Gancio gripper U / U-Gripper

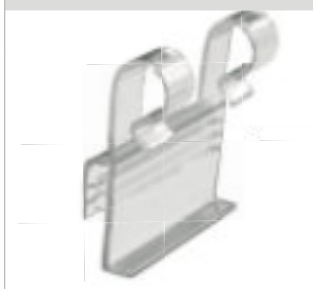

Cod.
Item-No.

Confezione
Pack

KAN-U-Gripper

100 pezzi / pieces

Gancio in plastica, ideale per sospendere i portadocumenti su ceste metalliche, con 2 anelli di aggancio e linguetta in plastica per mantenere in verticale il portadocumenti.
Dimensioni (LxH): 35 x 40 mm

Plastic hook, ideal for suspending i document holder on metal baskets, with 2 hook rings and plastic tab for keep the document holder upright.
Dimensions (WxH): 35 x 40 mm

Fascette in plastica / Plastic Binder

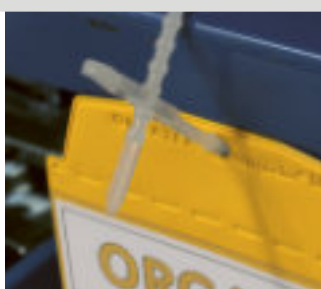

Cod.
Item-No.

Confezione
Pack

MA2050

50 pezzi / pieces

Fascette in plastica resistente con blocco posizione, ideale per sospendere i portadocumenti su vari supporti.
Riutilizzabile.
Lunghezza: 320 mm

Plastic ties are useful when you need to permanently secure pockets, or attach them to profiles, cables, etc. The special locking mechanism enables multiple applications.
Reusable.
Length: 320 mm

Punto velcro / Hook-and-loop dot



Cod.
Item-No.

Confezione (base + velcro)
Set (base + velcro)

PFH22

100 paia / pair

Velcro ad alta forza adesiva Ø 22 mm
Ancoraggio veloce su qualsiasi superficie.
Set = 100 basi e 100 velcro.

Hook-and-loop dot (ø 22 mm) with high adhesive force for detachable connections. Easy fixing of a wide range of materials.
Set= 100 soft (loop) dots and 100 hook dots.

Soluzioni per sospensione

Mounting Options

Nastro metallico adesivo / Self-adhesive metal tape

		Cod. Item-No.	Rotolo Roll
 		BMS35	1 rotolo (5 metri) / roll (5 meters)
		<p>Ideale per rendere metalliche superfici che richiedono l'utilizzo di componenti dotati di magneti. Dimensioni: 35 x 5000 mm.</p>	<p><i>The self-adhesive metal tape with powerful adhesion is particularly suitable for making non-metallic materials magnetic. Uneven areas on the surface to be bonded are compensated for by the foam adhesive applied on the back. The product can be worked from the roll (35 x 5000 mm) and cut directly to size with scissors.</i></p>

VST Gripper / VST Gripper

		Cod. Item-No.	Pack Pack
 		VST-GRIPPER	50 pezzi / pieces
		<p>Gancio Gripper, ideali per sospendere portadocumenti su tubolare. Utilizzabile anche con VST-Label (Vedi pag. 81). Diametro 28-30 mm.</p>	<p><i>With the round-tube label holder, visual pockets or label holders can be attached flexibly to round tubes with a diameter of 28-30 mm without any problems. Grip points on the inside prevent slipping when inserting or removing the label.</i></p>

ORGATEX[®]



Portadocumenti adesivi

Visual Pockets self-adhesive

Grazie a forti strisce adesive in schiuma, sul retro, tutti i tipi di portadocumenti possono essere attaccati alla superficie appropriata. Non importa se si tratta di metallo, legno, plastica, metallo non magnetico o vetro: aderisce saldamente anche con forti vibrazioni e su superfici irregolari.

With strong foam adhesive strips on the back, all pocket types can be mounted on suitable surface (metal, wood, plastics, non-magnetical metals, glass). Secure attachment, even with strong vibrations or uneven surfaces.

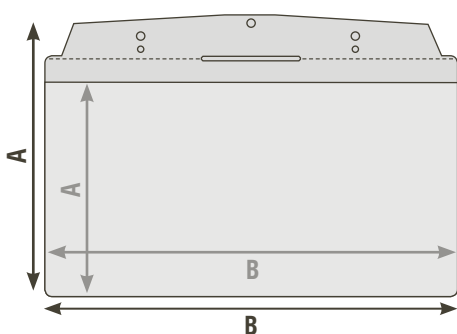

Formati DIN e dimensioni esterne (mm) / interne (mm)

Existing formats in mm outer dimensions (mm) / inner dimensions (mm)

	1/3	A7 orizz. A7 landsc.	A6 orizz. A6 landsc.	A5 orizz. A5 landsc.	A5 vert. A5 portr.	A4 orizz. A4 landsc.	A4 vert. A4 portr.
A	160 / 108	112 / 70	159 / 111	205 / 152	264 / 217	268 / 217	335 / 328
B	230 / 225	115 / 112	159 / 156	230 / 225	160 / 153	325 / 322	229 / 225

ORGATEX®



Portadocumenti adesivi

Visual Pockets self-adhesive

Versione Standard - 1 Striscia Adesiva / With 1 foam adhesive strip

	Formato Format	Cod. Item-No.	+ Colore + Color											Confezione Pack
			01	02	03	04	05	06	07	08	20			
	DIN A7 orizz. / landsc.	SDSK/7110-	01	02	03	04	05	06	07	08	20	50 pezzi / pieces		
	DIN A6 orizz. / landsc.	SDSK/6110-	01	02	03	04	05	06	07	08	20	50 pezzi / pieces		
	1/3 DIN	SDSK/1310-	01	02	03	04	05	06	07	08	20	50 pezzi / pieces		
	DIN A5 orizz. / landsc.	SDSK/5110-	01	02	03	04	05	06	07	08	20	50 pezzi / pieces		
	DIN A5 vert. / portr.	SDSK/5210-	01	02	03	04	05	06	07	08	20	50 pezzi / pieces		
	DIN A4 vert. / portr.	SDSK/4210-	01	02	03	04	05	06	07	08	20	50 pezzi / pieces		
	DIN A4 orizz. / landsc.	SDSK/4110-	01	02	03	04	05	06	07	08	20	50 pezzi / pieces		

Versione Speciale - 2 Strisce Adesive / With 2 foam adhesive strips

	Formato Format	Cod. Item-No.	+ Colore + Color											Confezione Pack
			01	02	03	04	05	06	07	08	20			
	DIN A7 orizz. / landsc.	2SDSK/7110-	01	02	03	04	05	06	07	08	20	50 pezzi / pieces		
	DIN A6 orizz. / landsc.	2SDSK/6110-	01	02	03	04	05	06	07	08	20	50 pezzi / pieces		
	1/3 DIN	2SDSK/1310-	01	02	03	04	05	06	07	08	20	50 pezzi / pieces		
	DIN A5 orizz. / landsc.	2SDSK/5110-	01	02	03	04	05	06	07	08	20	50 pezzi / pieces		
	DIN A5 vert. / portr.	2SDSK/5210-	01	02	03	04	05	06	07	08	20	50 pezzi / pieces		
	DIN A4 vert. / portr.	2SDSK/4210-	01	02	03	04	05	06	07	08	20	50 pezzi / pieces		
	DIN A4 orizz. / landsc.	2SDSK/4110-	01	02	03	04	05	06	07	08	20	50 pezzi / pieces		

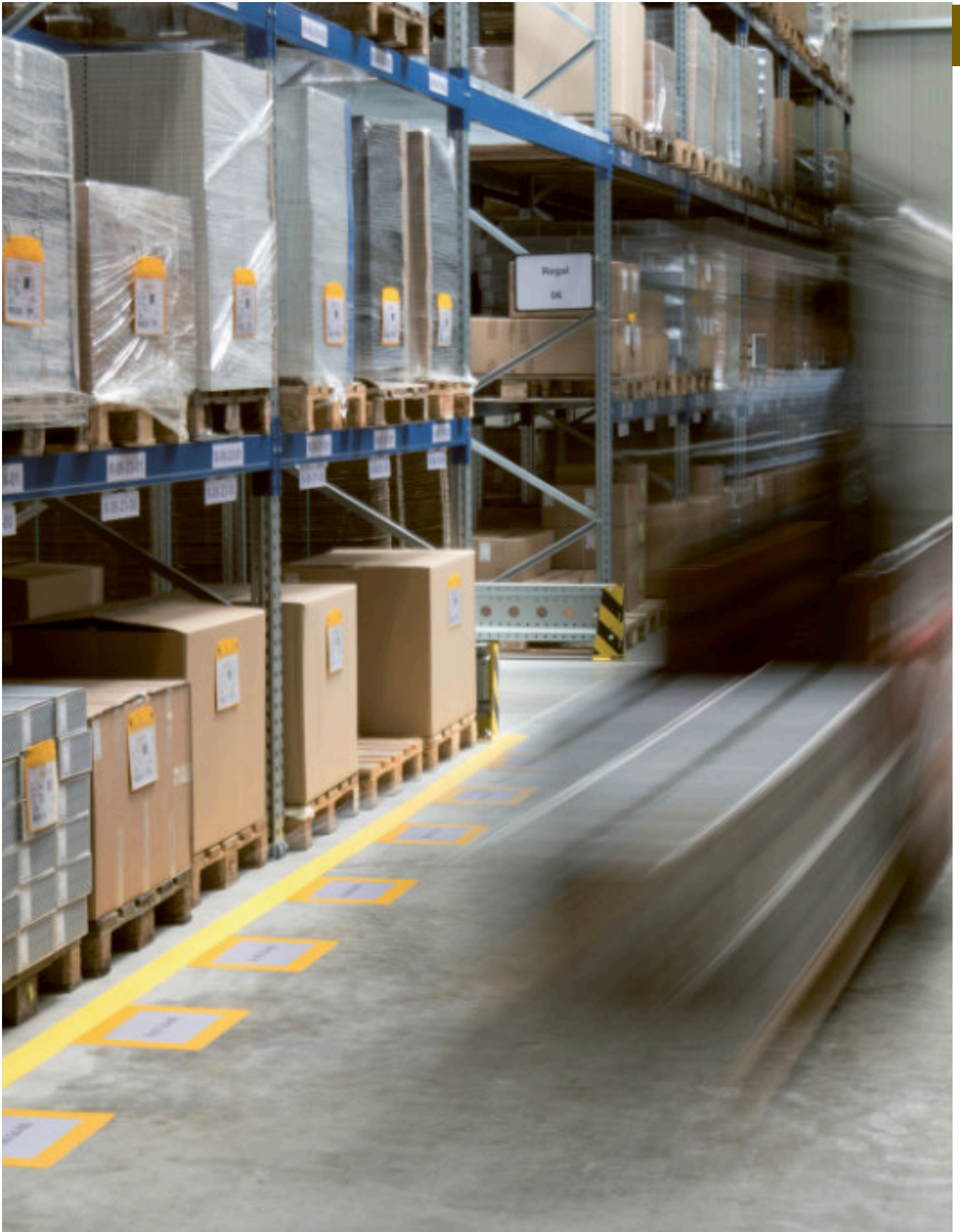

Portadocumenti magnetici

Visual Pockets magnetic

Portadocumenti magnetico prodotto in plastica PVC resistente. La parte frontale trasparente permette la lettura dei documenti senza doverli togliere dal portadocumenti. Con striscia magnetica alta 25 mm e uno spessore di 2 mm, offre una forza di adesione molto elevata.

These magnetic pockets are made of extremely durable plastic with a reinforced header section and a transparent front side so that inserted documents can be read / scanned without removal. With a width of 25 mm and a thickness of 2 mm, the magnetic strip on the back side delivers a very high bonding strength.

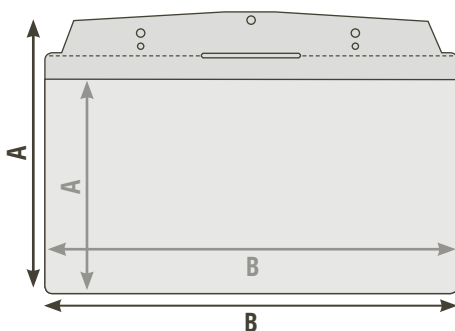

Formati DIN e dimensioni esterne (mm) / interne (mm)
Existing formats in mm outer dimensions (mm) / inner dimensions (mm)

	1/3	A7 orizz. A7 landsc.	A6 orizz. A6 landsc.	A5 orizz. A5 landsc.	A5 vert. A5 portr.	A4 orizz. A4 landsc.	A4 vert. A4 portr.
A	160 / 108	112 / 70	159 / 111	205 / 152	264 / 217	268 / 217	335 / 328
B	230 / 225	115 / 112	159 / 156	230 / 225	160 / 153	325 / 322	229 / 225

ORGATEX®



Portadocumenti magnetici

Visual Pockets magnetic

Versione Standard - 1 striscia magnetica / 1 Magnetic strip

	Formato <i>Format</i>	Cod. <i>Item-No.</i>	+ Colore	Confezione <i>Pack</i>
			+ Color	
	DIN A7 orizz. / <i>landsc.</i>	MA7110-	01 02 03 04 05 06 07 08 20	50 pezzi / <i>pieces</i>
	DIN A6 orizz. / <i>landsc.</i>	MA6110-	01 02 03 04 05 06 07 08 20	50 pezzi / <i>pieces</i>
	1/3 DIN	MA1310-	01 02 03 04 05 06 07 08 20	50 pezzi / <i>pieces</i>
	DIN A5 orizz. / <i>landsc.</i>	MA5110-	01 02 03 04 05 06 07 08 20	50 pezzi / <i>pieces</i>
	DIN A5 vert. / <i>portr.</i>	MA5210-	01 02 03 04 05 06 07 08 20	50 pezzi / <i>pieces</i>
	DIN A4 vert. / <i>portr.</i>	MA4210-	01 02 03 04 05 06 07 08 20	50 pezzi / <i>pieces</i>
	DIN A4 orizz. / <i>landsc.</i>	MA4110-	01 02 03 04 05 06 07 08 20	50 pezzi / <i>pieces</i>

Versione Speciale - 2 strisce magnetiche / 2 Magnetic strips

	Formato <i>Format</i>	Cod. <i>Item-No.</i>	+ Colore	Confezione <i>Pack</i>
			+ Color	
	DIN A7 orizz. / <i>landsc.</i>	SD2M/7110-	01 02 03 04 05 06 07 08 20	50 pezzi / <i>pieces</i>
	DIN A6 orizz. / <i>landsc.</i>	SD2M/6110-	01 02 03 04 05 06 07 08 20	50 pezzi / <i>pieces</i>
	1/3 DIN	SD2M/1310-	01 02 03 04 05 06 07 08 20	50 pezzi / <i>pieces</i>
	DIN A5 orizz. / <i>landsc.</i>	SD2M/5110-	01 02 03 04 05 06 07 08 20	50 pezzi / <i>pieces</i>
	DIN A5 vert. / <i>portr.</i>	SD2M/5210-	01 02 03 04 05 06 07 08 20	50 pezzi / <i>pieces</i>
	DIN A4 vert. / <i>portr.</i>	SD2M/4210-	01 02 03 04 05 06 07 08 20	50 pezzi / <i>pieces</i>
	DIN A4 orizz. / <i>landsc.</i>	SD2M/4110-	01 02 03 04 05 06 07 08 20	50 pezzi / <i>pieces</i>

Versione Speciale - 4 strisce magnetiche / 4 Magnetic strips

	Formato <i>Format</i>	Cod. <i>Item-No.</i>	+ Colore	Confezione <i>Pack</i>
			+ Color	
	DIN A5 orizz. / <i>landsc.</i>	SD4M/5110-	01 02 03 04 05 06 07 08 20	50 pezzi / <i>pieces</i>
	DIN A5 vert. / <i>portr.</i>	SD4M/5210-	01 02 03 04 05 06 07 08 20	50 pezzi / <i>pieces</i>
	DIN A4 vert. / <i>portr.</i>	SD4M/4210-	01 02 03 04 05 06 07 08 20	50 pezzi / <i>pieces</i>
	DIN A4 orizz. / <i>landsc.</i>	SD4M/4110-	01 02 03 04 05 06 07 08 20	50 pezzi / <i>pieces</i>

Versione Speciale - intera superficie magnetica / Full-surface magnet

	Formato <i>Format</i>	Cod. <i>Item-No.</i>	+ Colore	Confezione <i>Pack</i>
			+ Color	
	DIN A6 orizz. / <i>landsc.</i>	SDVF/6110-	01 02 03 04 05 06 07 08 20	50 pezzi / <i>pieces</i>
	1/3 DIN	SDVF/1310-	01 02 03 04 05 06 07 08 20	50 pezzi / <i>pieces</i>
	DIN A5 orizz. / <i>landsc.</i>	SDVF/5110-	01 02 03 04 05 06 07 08 20	50 pezzi / <i>pieces</i>
	DIN A5 vert. / <i>portr.</i>	SDVF/5210-	01 02 03 04 05 06 07 08 20	50 pezzi / <i>pieces</i>
	DIN A4 vert. / <i>portr.</i>	SDVF/4210-	01 02 03 04 05 06 07 08 20	50 pezzi / <i>pieces</i>
	DIN A4 orizz. / <i>landsc.</i>	SDVF/4110-	01 02 03 04 05 06 07 08 20	50 pezzi / <i>pieces</i>

Portadocumenti magnetici (con chiusura)

Visual Pockets magnetic (Protective Flap)

ORGATEX®

Versione standard con chiusura - 1 striscia magnetica / 1 Magnetic strip (Protective Flap)

Formato <i>Format</i>	Cod. <i>Item-No.</i>	+ Colore <i>+ Color</i>										Confezione <i>Pack</i>
		01	02	03	04	05	06	07	08	20		
	DIN A5 orizz. / <i>landsc.</i>	MA5111-	01	02	03	04	05	06	07	08	20	50 pezzi / <i>pieces</i>
	DIN A4 vert. / <i>portr.</i>	MA4211-	01	02	03	04	05	06	07	08	20	50 pezzi / <i>pieces</i>
	DIN A4 orizz. / <i>landsc.</i>	MA4111-	01	02	03	04	05	06	07	08	20	50 pezzi / <i>pieces</i>

Versione speciale con chiusura - 2 strisce magnetiche / 2 Magnetic strips (Protective Flap)

Formato <i>Format</i>	Cod. <i>Item-No.</i>	+ Colore <i>+ Color</i>										Confezione <i>Pack</i>
		01	02	03	04	05	06	07	08	20		
	DIN A5 orizz. / <i>landsc.</i>	SD2M/5111-	01	02	03	04	05	06	07	08	20	50 pezzi / <i>pieces</i>
	DIN A4 vert. / <i>portr.</i>	SD2M/4211-	01	02	03	04	05	06	07	08	20	50 pezzi / <i>pieces</i>
	DIN A4 orizz. / <i>landsc.</i>	SD2M/4111-	01	02	03	04	05	06	07	08	20	50 pezzi / <i>pieces</i>

Versione speciale con chiusura - 4 strisce magnetiche / 4 Magnetic strips (Protective Flap)

Formato <i>Format</i>	Cod. <i>Item-No.</i>	+ Colore <i>+ Color</i>										Confezione <i>Pack</i>
		01	02	03	04	05	06	07	08	20		
	DIN A5 orizz. / <i>landsc.</i>	SD4M/5111-	01	02	03	04	05	06	07	08	20	50 pezzi / <i>pieces</i>
	DIN A4 vert. / <i>portr.</i>	SD4M/4211-	01	02	03	04	05	06	07	08	20	50 pezzi / <i>pieces</i>
	DIN A4 orizz. / <i>landsc.</i>	SD4M/4111-	01	02	03	04	05	06	07	08	20	50 pezzi / <i>pieces</i>

Versione speciale con chiusura - intera superficie magnetica / Full-surface magnet (Protective Flap)

Formato <i>Format</i>	Cod. <i>Item-No.</i>	+ Colore <i>+ Color</i>										Confezione <i>Pack</i>
		01	02	03	04	05	06	07	08	20		
	DIN A5 orizz. / <i>landsc.</i>	SDVF/5111-	01	02	03	04	05	06	07	08	20	50 pezzi / <i>pieces</i>
	DIN A4 vert. / <i>portr.</i>	SDVF/4211-	01	02	03	04	05	06	07	08	20	50 pezzi / <i>pieces</i>
	DIN A4 orizz. / <i>landsc.</i>	SDVF/4111-	01	02	03	04	05	06	07	08	20	50 pezzi / <i>pieces</i>

Portadocumenti magnetici Neodym

Visual Pockets super-magnetic

Portadocumenti magnetico Neodym prodotto in plastica PVC resistente. Nel caso in cui le vibrazioni durante il trasporto siano un problema, i due magneti in Neodym sono la soluzione ottimale.

Particolarmente indicato in caso di superfici di aggancio non regolari o molto piccole. Anche durante movimentazioni gravose (vibrazione, trasporto, ecc.) il fissaggio è stabile.

Disponibili versioni con magnete aggittivo e con chiusura.

When strong vibrations are produced during transport, the extra strong neodymium (NIB) magnets deliver the optimal solution. This super-magnet is designed for ferrous surfaces (wire-mesh baskets, skeleton boxes) or curved and or / uneven surfaces (e.g. barrels). Even with „rough“ handling (vibrations, transport, etc.) it ensures a secure hold.

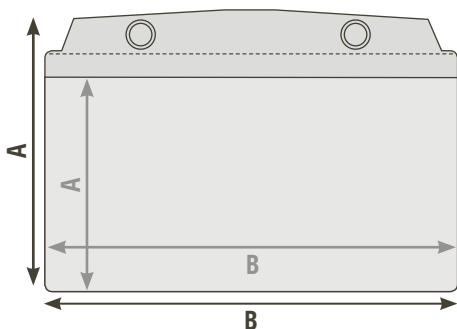

Formati DIN e dimensioni esterne (mm) / interne (mm)
Existing formats in mm outer dimensions (mm) / inner dimensions (mm)

	A6 orizz. A6 landsc.	A5 orizz. A5 landsc.	A4 orizz. A4 landsc.	A4 vert. A4 portr.
A	159 / 111	205 / 152	268 / 217	335 / 328
B	159 / 156	230 / 225	325 / 322	229 / 225

ORGATEX®



Portadocumenti magnetici Neodym

Visual Pockets super-magnetic

Versione Standard / Neodymium magnets

	Formato <i>Format</i>	Cod. <i>Item-No.</i>	+ Colore	Confezione <i>Pack</i>
			+ Color	
	DIN A6 orizz. / <i>landsc.</i>	MUV2260-	01 02 03 04 05 06 07 08 20	50 pezzi / <i>pieces</i>
	DIN A5 orizz. / <i>landsc.</i>	MUV2250-	01 02 03 04 05 06 07 08 20	50 pezzi / <i>pieces</i>
	DIN A4 vert. / <i>portr.</i>	MUV2240-	01 02 03 04 05 06 07 08 20	50 pezzi / <i>pieces</i>
	DIN A4 orizz. / <i>landsc.</i>	MUV2230-	01 02 03 04 05 06 07 08 20	50 pezzi / <i>pieces</i>

Versione Speciale - 1 striscia magnetica / Neodymium magnets and magnetic strip

	Formato <i>Format</i>	Cod. <i>Item-No.</i>	+ Colore	Confezione <i>Pack</i>
			+ Color	
	DIN A6 orizz. / <i>landsc.</i>	MUV260-	01 02 03 04 05 06 07 08 20	50 pezzi / <i>pieces</i>
	DIN A5 orizz. / <i>landsc.</i>	MUV250-	01 02 03 04 05 06 07 08 20	50 pezzi / <i>pieces</i>
	DIN A4 vert. / <i>portr.</i>	MUV240-	01 02 03 04 05 06 07 08 20	50 pezzi / <i>pieces</i>
	DIN A4 orizz. / <i>landsc.</i>	MUV230-	01 02 03 04 05 06 07 08 20	50 pezzi / <i>pieces</i>

Versione Standard con chiusura / Neodymium magnets (Protective Flap)

	Formato <i>Format</i>	Cod. <i>Item-No.</i>	+ Colore	Confezione <i>Pack</i>
			+ Color	
	DIN A5 orizz. / <i>landsc.</i>	MUV2251-	- - - - - 07 - -	50 pezzi / <i>pieces</i>
	DIN A4 vert. / <i>portr.</i>	MUV2241-	- - - - - 07 - -	50 pezzi / <i>pieces</i>
	DIN A4 orizz. / <i>landsc.</i>	MUV2231-	- - - - - 07 - -	50 pezzi / <i>pieces</i>

Versione Speciale con chiusura - 1 striscia magnetica / Neodymium magnets and magnetic strip (Protective Flap)

	Formato <i>Format</i>	Cod. <i>Item-No.</i>	+ Colore	Confezione <i>Pack</i>
			+ Color	
	DIN A5 orizz. / <i>landsc.</i>	MUV251-	- - - - - 07 - -	50 pezzi / <i>pieces</i>
	DIN A4 vert. / <i>portr.</i>	MUV241-	- - - - - 07 - -	50 pezzi / <i>pieces</i>
	DIN A4 orizz. / <i>landsc.</i>	MUV231-	- - - - - 07 - -	50 pezzi / <i>pieces</i>

Tasca magnetica

Magnetic poket

Tasche magnetiche con plastica frontale trasparente per l'alloggiamento dei documenti. Realizzate in magnete morbido di spessore 1,1 mm. Con le loro superfici interamente magnetiche permettono di essere fissate stabilmente su tutte le superfici metalliche.

- Retro interamente magnetico
- Fronte trasparente
- Adatto per lettore codice a barre

Magnetic pockets with transparent front plastic for housing documents. Made of 1.1 mm thick soft magnet. With their entirely magnetic surfaces, they allow them to be fixed stably on all metal surfaces.

- Fully magnetic back
- Transparent front
- Suitable for barcode reader

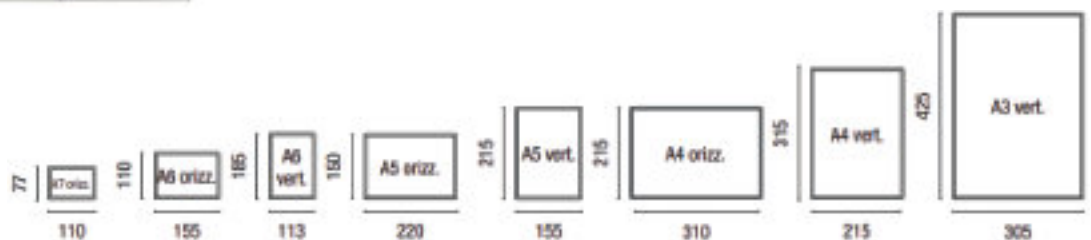

Tasca magnetica / Magnetic poket				
	Formato documenti <i>For DIN Document Format</i>	Dimensione (LxH) (mm) <i>Dimension (WxH) (mm)</i>	Cod. <i>Item-No.</i>	Confezione <i>Pack</i>
	DIN A7 orizz. <i>DIN A7 landsc.</i>	110 x 77	LP-TMA70	10
	DIN A6 orizz. <i>DIN A6 landsc.</i>	155 x 110	LP-TMA60	10
	DIN A6 vert. <i>DIN A6 portrait</i>	113 x 158	LP-TMA6V	10
	DIN A5 orizz. <i>DIN A5 landsc.</i>	220 x 150	LP-TMA50	10
	DIN A5 vert. <i>DIN A5 portr.</i>	155 x 215	LP-TMA5V	10
	DIN A4 orizz. <i>DIN A4 landsc.</i>	310 x 215	LP-TMA40	10
	DIN A4 vert. <i>DIN A4 portr.</i>	215 x 315	LP-TMA4V	10
	DIN A3 vert. <i>DIN A5 portr.</i>	305 x 425	LP-TMA3V	5
	- Tasche magnetiche morbide con superficie posteriore completamente magnetica e fronte trasparente - Spessore 1,1 mm		- Soft magnetic pockets with fully magnetic back surface and transparent front - 1.1 mm thick	

Finestra magnetica

Magnetic window

Le finestre magnetiche sono caratterizzate da un bordo colorato di 16 mm a vista. Il retro è composto da 3 lati magnetici e il bordo inferiore è adesivo. La parte centrale è trasparente e scrivibile con pennarelli a base d'acqua.

- Facile sostituzione dei documenti
- Fissaggio permanente con striscia adesiva
- Superficie scrivibile con pennarelli ad acqua (vedi pag. 249)

Magnetic windows feature a 16 mm magnetic colored border on three sides and an adhesive border and a clear center and writable with water-based markers.

- Easy replacement of documents
- Permanent fixing with adhesive strip
- Writable surface with water-based markers (Pag.249)

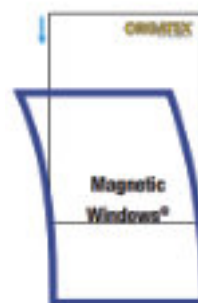

- Magnetico - Magnetic
- Adesivo - Adhesive

Finestra magnetica / Magnetic windows

Formato Format	Dimensioni int. / est. (LxH) Inner / outer dim. (WxH)	Cod. Item-No.	+ Colore + Color	Confezione Pack
DIN A5 orizz. / landsc.	210 x 148 mm / 235 x 173 mm	KAN-MW-A5Q-	01 03 04 05 07 08	10 pezzi / pieces
DIN A4 vert. / portr.	210 x 297 mm / 235 x 322 mm	KAN-MW-A4H-	01 03 04 05 07 08	10 pezzi / pieces
DIN A4 orizz. / landsc.	297 x 210 mm / 322 x 235 mm	KAN-MW-A4Q-	01 03 04 05 07 08	10 pezzi / pieces
DIN A3 vert. / portr.	297 x 420 mm / 322 x 445 mm	KAN-MW-A3H-	01 03 04 05 07 08	10 pezzi / pieces
DIN A3 orizz. / landsc.	420 x 297 mm / 445 x 322 mm	KAN-MW-A3Q-	01 03 04 05 07 08	10 pezzi / pieces
DIN A2 vert. / portr.	420 x 594 mm / 445 x 620 mm	KAN-MW-A2H-	01 03 04 05 07 -	1 pezzo / piece
DIN A2 orizz. / landsc.	594 x 420 mm / 620 x 445 mm	KAN-MW-A2Q-	01 03 04 05 07 -	1 pezzo / piece
DIN A1 orizz. / landsc.	841 x 594 mm / 865 x 620 mm	KAN-MW-A1Q-	01 03 04 05 07 -	1 pezzo / piece



Cornici magnetiche / Magnetic windows Frames

Formato <i>Format</i>	Dimensioni int. / est. (LxH) <i>Inner / outer dim. (WxH)</i>	Cod. <i>Item-No.</i>	+ Colore <i>+ Color</i>	Confezione <i>Pack</i>
DIN A4 vert. / <i>portr.</i>	210 x 297 mm / 234 x 321 mm	KAN-MWR-A4H-	01 03 04 05 07 08	10 pezzi / <i>pieces</i>
DIN A4 orizz. / <i>landsc.</i>	297 x 210 mm / 321 x 234 mm	KAN-MWR-A4Q-	01 03 04 05 07 08	10 pezzi / <i>pieces</i>
DIN A3 vert. / <i>portr.</i>	297 x 420 mm / 321 x 444 mm	KAN-MWR-A3H-	01 03 04 05 07 08	10 pezzi / <i>pieces</i>
DIN A3 orizz. / <i>landsc.</i>	420 x 297 mm / 444 x 321 mm	KAN-MWR-A3Q-	01 03 04 05 07 08	10 pezzi / <i>pieces</i>

Parte centrale libera da protezione per permettere la scrittura diretta sul foglio sottostante.

Central part free from protection to allow direct writing on the underlying sheet.

Titoli per finestre magnetiche

Magnetic windows Titles

Stesso principio delle finestre magnetiche ma di dimensioni inferiori. Posizionati sopra di esse, possono essere utilizzati per inserire titoli e intestazioni.

- Facile sostituzione dei documenti
- Fissaggio permanente con striscia adesiva
- Superficie scrivibile con pennarelli ad acqua (vedi pag. 249)

Same principle as magnetic windows but in dimensions inferior. Placed above them, they can be used to insert titles and headings.

- *Easy replacement of documents*
- *Permanent fixing with adhesive strip*
- *Writable surface with water-based markers (Pag.249)*

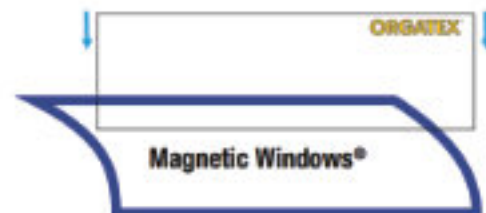

- **Magnetico** - *Magnetic*
- **Adesivo** - *Adhesive*



Titoli per finestre magnetiche / Magnetic windows Titles

Formato <i>Format</i>	Dimensioni interne / esterne (LxH) <i>Inner / outer dim. (WxH)</i>	Cod. <i>Item-No.</i>	+ Colore <i>+ Color</i>	Confezione <i>Pack</i>
DIN A4 vert. / <i>portr.</i>	210 x 48 mm / 235 x 70 mm	KAN-MWH-A4H-	01 03 04 05 07 08	10 pezzi / <i>pieces</i>
DIN A4 orizz. / <i>landsc.</i>	297 x 48 mm / 322 x 70 mm	KAN-MWH-A4Q-	01 03 04 05 07 08	10 pezzi / <i>pieces</i>
DIN A3 orizz. / <i>landsc.</i>	420 x 48 mm / 445 x 70 mm	KAN-MWH-A3Q-	01 03 04 05 07 08	10 pezzi / <i>pieces</i>

Finestre adesive riposizionabili

Multi windows

- Ideale per superfici lisce (vetro, plastica, metallo)
- Superficie scrivibile con pennarelli ad acqua (vedi pag. 249)
- Rimovibile senza residui
- Possono essere riutilizzate

- Adheres to smooth surfaces (e.g. glass, metal, plastic, etc.)
- Writable surface with water-based markers (Pag.249)
- Removable without residues
- Can be used several times

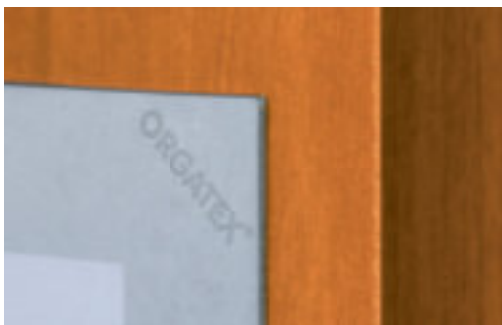

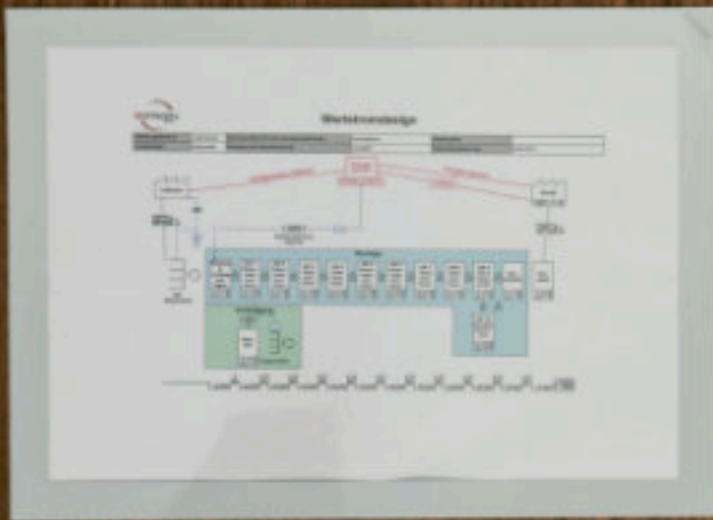

Finestre adesive riposizionabili / Multi windows

Formato <i>Format</i>	Dimensioni int. / est. (LxH) <i>Inner / outer dim. (WxH)</i>	Cod. <i>Item-No.</i>	+ Colore <i>+ Color</i>	Confezione <i>Pack</i>
DIN A4	212 x 300 mm / 231 x 318 mm	KAN-MU-A4-	01 03 04 05 07 08	10 pezzi / <i>pieces</i>
DIN A5	151 x 212 mm / 169 x 231 mm	KAN-MU-A5-	- - - - 07 -	10 pezzi / <i>pieces</i>
DIN A3	298 x 422 mm / 318 x 441 mm	KAN-MU-A3-	- - - - 07 -	10 pezzi / <i>pieces</i>

Tablelle informative adesive o magnetiche

Adhesive or magnetic information board

La plastica rigida trasparente permette un facile aggiornamento dei dati per una maggiore trasparenza nelle informazioni aziendali. Le bande laterali colorate non sono solo per estetica ma diventano un mezzo per differenziare la tipologia di informazione attraverso il Visual Management.

The clear rigid plastic allows for easy updating of data for greater transparency in business information. The colored side bands are not just for aesthetics but become a means of differentiating the type of information through Visual Management.





Tabelle informative adesive o magnetiche / Adhesive or magnetic information board

Formato <i>Format</i>	Descrizione <i>Description</i>	Dimensione (LxH) (mm) <i>Dimension (WxH) (mm)</i>	Cod. <i>Item-No.</i>	+ Colore <i>+ Color</i>	Confezione <i>Pack</i>
DIN A4	2 strisce adesive / 2 adhesive stripes	210 x 297	KN-SK4-	01 02 03 04 05 06 07	10 pezzi / pieces
DIN A3	2 strisce adesive / 2 adhesive stripes	420 x 297	KN-SK3-	01 02 03 04 05 06 07	10 pezzi / pieces
DIN A4	2 strisce magnetiche / 2 magnetic stripes	210 x 297	KN-M4-	01 02 03 04 05 06 07	10 pezzi / pieces
DIN A3	2 strisce magnetiche / 2 magnetic stripes	420 x 297	KN-M3-	01 02 03 04 05 06 07	10 pezzi / pieces

Cartella con clip

Clip Board

In assenza di blocchi per appunti la nostra cartella con clip è la soluzione perfetta. Gli angoli della clip rivestiti in gomma forniscono un'ottima presa del foglio. Grazie alla sua misura standard la versione magnetica può essere perfettamente abbinata alle nostre finestre magnetiche su tutte le lavagne.

- In plastica resistente (polistirene)
- Clip in metallo rivestita in gomma per un'ottima tenuta
- Retro magnetico (nella versione magnetica)
- Capacità: circa 60 fogli

If there is no writing pad available, our Clip Board is the perfect assistant. The additional rubber coating on the clip provides an excellent support for each kind of document. Due to its standardized size the Clip Board matches well with our magnetic windows on all boards.

- Made of durable plastic (polystyrene)
- Rubberized clip for secure hold
- Magnetic back (in the magnetic version)
- Capacity of approximately 60 sheets

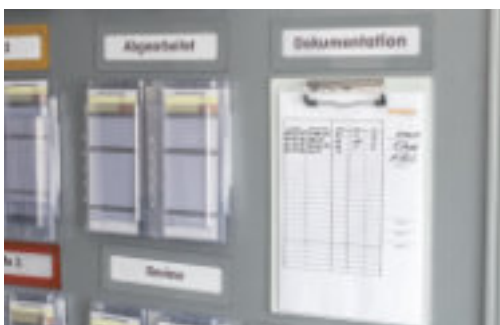



Cartella con clip / Clip Board

Formato <i>Format</i>	Dimensione (LxH) (mm) <i>Dimension (WxH) (mm)</i>	Cod. <i>Item-No.</i>	Confezione <i>Pack</i>
DIN A4 vert. / <i>portr.</i>	234 x 321	VB-KB-A4H	2 pezzi / <i>pieces</i>
DIN A4 orizz. / <i>landsc.</i>	321 x 234	VB-KB-A4Q	2 pezzi / <i>pieces</i>
DIN A4 vert. magnetico / <i>portr. magnetic</i>	234 x 321	VB-KBM-A4H	2 pezzi / <i>pieces</i>
DIN A4 orizz. magnetico / <i>landsc. magnetic</i>	321 x 234	VB-KBM-A4Q	2 pezzi / <i>pieces</i>

Raccoglitore ad anelli

FLIP-MAG

Permette di dare visibilità ai propri documenti ovunque ci sia una superficie metallica. È sufficiente appoggiare il raccoglitore ad anelli sulla superficie, inserire i fogli nelle buste ed il gioco è fatto. I magneti Neodym permettono di ancorare i singoli fogli alla superficie sia verticalmente che orizzontalmente per dare risalto alle informazioni.

- Plastica rigida per il supporto dei documenti
- Magnete Neodym
- Plastica antiriflesso
- Leggibile fronte-retro

Visual pockets made of plastic, 4 holes punched with neodymium magnet. The documents can be inserted in vertical or horizontal position. The pockets can be used portrait and / or landscape format.

- Rigid plastic for document support
- Neodym magnet
- Anti-reflection plastic
- Double-sided readable

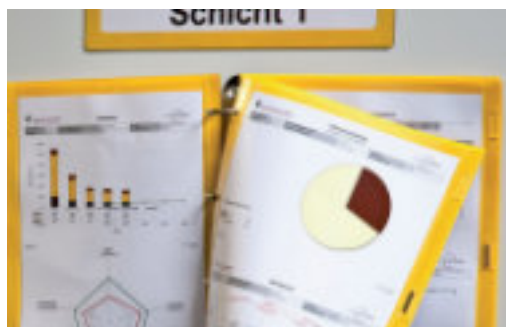



Busta magnetica forata e Raccogliatore ad anelli / FLIP-MAG, Ring binder mechanism

Descrizione <i>Description</i>	Cod. <i>Item-No.</i>	+ Colore <i>+ Color</i>	Confezione <i>Pack</i>
*Busta magnetica forata / FLIP-MAG	FLIP-MAG-	01 02 03 04 05 06 07 08	10 pezzi / <i>pieces</i>
Raccogliatore magnetico ad anelli / <i>Ring binder mechanism, magnetic</i>	RBM-MA-35	- - - - - - - -	1 pezzo / <i>piece</i>
Raccogliatore ad anelli / <i>Ring binder mechanism</i>	50.0010.0009	- - - - - - - -	1 pezzo / <i>piece</i>

*Disponibile versione ESD pag.258
ESD version available at pag. 258

Raccoglitore a libro

Desktop Document Holder

Per tutti i luoghi di lavoro dove è richiesta l'esposizione e la consultazione di informazioni in maniera chiara e visibile,

ad esempio:

- macchinari
- postazioni informatiche
- laboratori
- reception
- banchi di vendita
- casse, ecc.

È il sistema pratico e flessibile per presentare le informazioni. Nei pannelli formato A4 verticale possono essere inseriti listini, tabelle, disegni, istruzioni, immagini o testi. Gli elementi possono essere posizionati su un tavolo, fissati a muro o scaffali in maniera semplice. Disponibili anche nella versione magnetica.

The Visual Board System serves as a flexible information board for workstations, which require well-arranged information. Price listings, tables, drawings, instructions, figures or texts can be easily inserted or suspended in one of the transparent insert modules (wall-mounted fixed to shelves or desks, put on top of a desk). Our highlight: Wall-mounted insert modules are now available in magnetic version. Information can be easily attached and rearranged on ferrous surfaces.



ORGATEX®



Componenti per raccoglitore a libro

Desktop Document Holder Accessories

Supporto da tavolo / Desk stand

	Numero di buste trasparenti <i>For number of document sleeves</i>	Colore <i>Color</i>	Cod. <i>Item-No.</i>
	10	Grigio / Grey	OT410
	20	Grigio / Grey	OT420
	30	Grigio / Grey	OT430
<p>Telaio in metallo stabile e robusto per 10, 20 o 30 buste portadocumenti, formato verticale.</p>			<p><i>Steady, robust metal frame for 10, 20 or 30 document sleeves, portrait format.</i></p>

Supporto a muro / Modules for wall mounting

	Descrizione <i>Description</i>	Cod. <i>Item-No.</i>
	Supporto base a muro per 10 buste / <i>Basic module with stop</i>	OT411
	Supporto aggiuntivo a muro per 10 buste / <i>Expansion module</i>	OT412
<p>Adatto per un massimo di 10 custodie per documenti. Espandibile, i moduli possono essere affiancati. I moduli base hanno elementi laterali rinforzati (rimovibili) per un supporto aggiuntivo.</p>		<p><i>Suitable for up to 10 document sleeves. Expandable, modules can be arranged side by side. Basic modules have reinforced side elements (removable) for additional support.</i></p>

Supporto base magnetico / Modules with magnetic foil on the back

	Descrizione <i>Description</i>	Cod. <i>Item-No.</i>
	Supporto base magnetico per 10 buste / <i>Basic module with stop</i>	OT415
	Supporto aggiuntivo magnetico per 10 buste / <i>Expansion module</i>	OT416
<p>← Retro magnetico <i>Magnetic Foil</i></p>	<p>Adatto per un massimo di 10 custodie per documenti. Veloce e facile da installare su tutte le superfici ferrose grazie al forte magnete sul retro (ad es. scaffali, armadi in acciaio, ecc.)</p>	<p><i>Suitable for up to 10 document sleeves. Quick and easy to install on all ferrous surfaces due to strong adhesive magnetic foil on the back (e.g. shelves, steel cabinets, etc.)</i></p>

Braccio snodato + supporto per buste / Adjustable arm with fitted wall module

	Numero di buste supportate <i>For number of document sleeves</i>	Cod. <i>Item-No.</i>
	10	OT417
	<p>Adatto per un massimo di 10 buste trasparenti portadocumenti A4. Può essere montato su una scrivania tramite un morsetto.</p>	<p><i>Internal spring, suitable for up to 10 document sleeves. Can be mounted on a desk by means of a clamp.</i></p>

Supporto base specifico per supermarket / Shelf mount, revolving stand

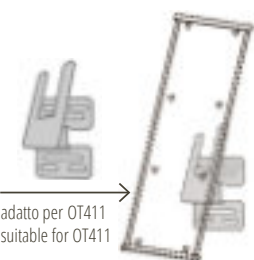
	Numero di buste supportate <i>For number of document sleeves</i>	Cod. <i>Item-No.</i>
 <p>adatto per OT411 suitable for OT411</p>	10	OT418
	<ul style="list-style-type: none"> - Da utilizzare con supporto base a muro OT411 (non incluso) - Angolato a 120° 	<ul style="list-style-type: none"> - Shelf mount allows for installing wall modules on perforated panels or shelf cross-members. - Angle of 120°, excellent reading position.

Buste trasparenti formato A4 / Document Sleeves DIN A4 portrait

	Colore <i>Color</i>	Cod. <i>Item-No.</i>	Confezione <i>Pack</i>
	Bianco / White	OT440	10 pezzi / pieces
	Rosso / Red	OT441	10 pezzi / pieces
	Blu / Blue	OT442	10 pezzi / pieces
	Giallo / Yellow	OT443	10 pezzi / pieces
	Verde / Green	OT444	10 pezzi / pieces
	<ul style="list-style-type: none"> - Buste trasparenti formato A4 per supporto documenti - Leggibili fronte/retro 	<ul style="list-style-type: none"> - Transparent, non-reflecting plastic, framed with plastic-coated steel wire. Easily adjustable due to virtual pivot. 	

Linguette identificative per buste trasparenti A4 / Suitable tabs

	Cod. <i>Item-No.</i>	Lunghezza (mm) <i>Length (mm)</i>	Confezione <i>Pack</i>
	OT50	50	10 pezzi / pieces
	<ul style="list-style-type: none"> - Per buste portadocumenti DIN A4 verticale. 1 Etichetta (Altezza 12 mm) 	<ul style="list-style-type: none"> - For Document Sleeves DIN A4 portrait. 1 Cardboard label (Height 12 mm) per Tab 	

Portadocumenti per contenitori

Infographic Document Holders

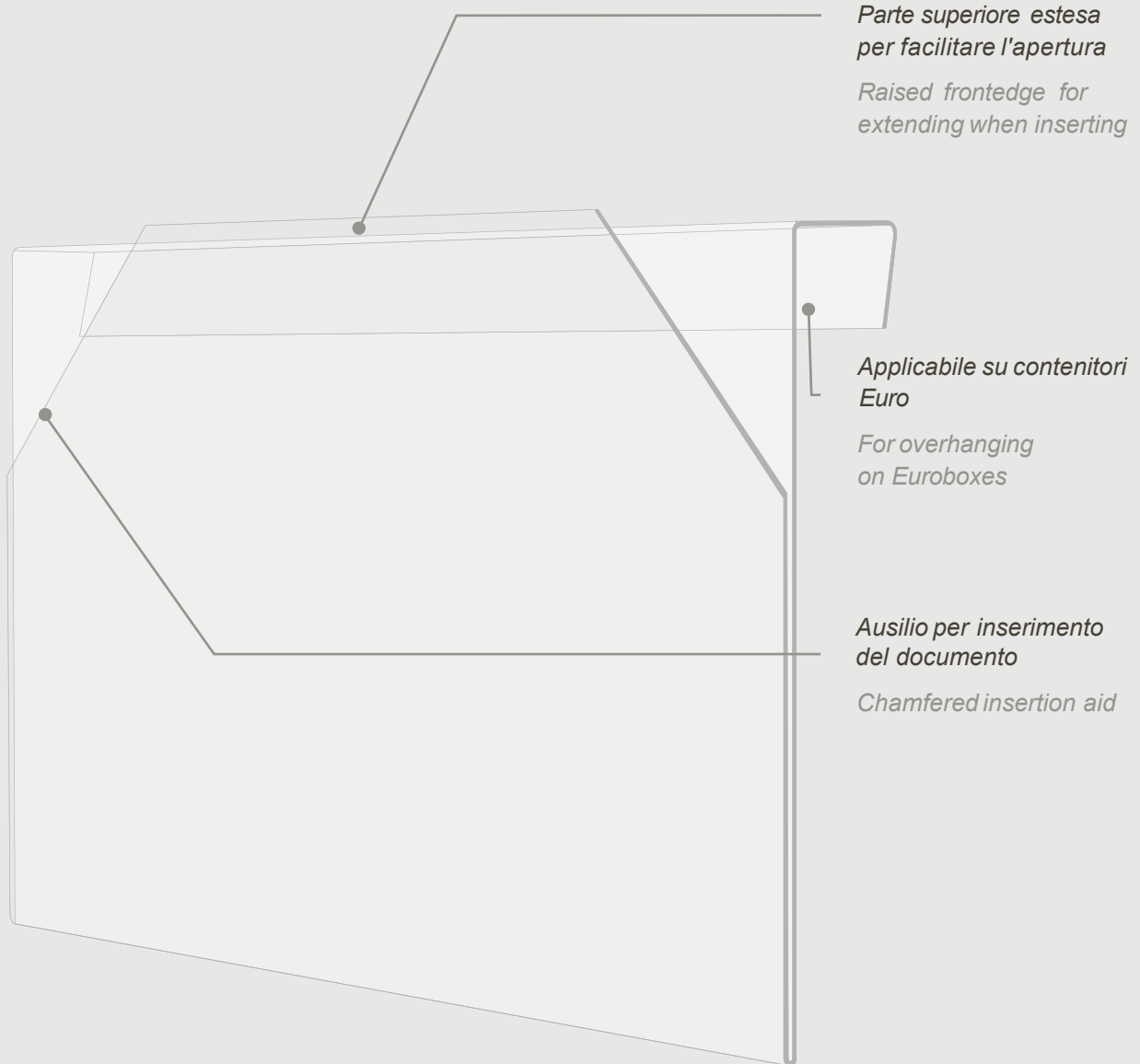

Applicabile ad ogni contenitore
Suitable for all containers



Per etichette rimovibili o fisse
For flexible or permanent labeling

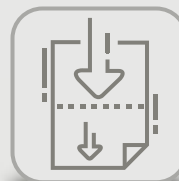

Disponibile cartoncino pretagliato per una stampa precisa
Pre-punched cardboards for precise printing

ORGATEX®

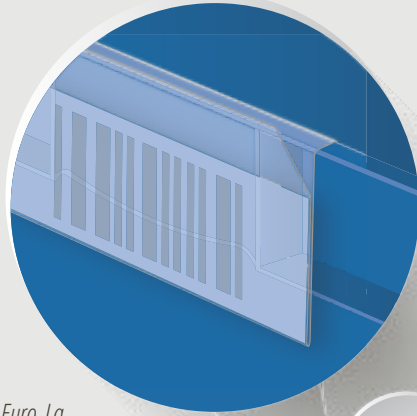

Appendibile

In PVC rigido trasparente, da appendere a contenitori, scatole di plastica, ecc. La finestra di visualizzazione è leggibile tramite scanner, il bordo anteriore inclinato facilita l'inserimento e l'estrazione dei documenti.

Overhang cover

Label holder made from transparent, UV-resistant PVC for hanging over boxes, plastic crates, etc. The transparent window is scanner legible. The chamfered front edge allows for easy insertion and removal of labels.

Porta etichette

Su misura per contenitori KLT ed Euro. La fessura laterale protegge le etichette da sporco e umidità.

Label holder

A perfect fit for KLT containers and euroboxes. The labels are protected from any dirt and moisture thanks to the lateral insertion slot.

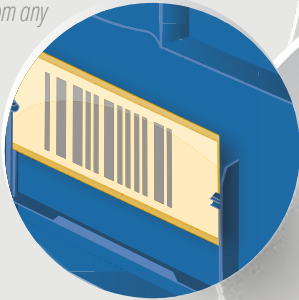

Formati standard

Standard Format sizes

Profili di bloccaggio a innesto

Con adesivo in schiuma sul retro per l'applicazione di schede materiale, informazioni sugli articoli, tasche per etichette su scatole di plastica e pallet di legno.

Insert label holder

With foam adhesive on the back for attaching material cards, item information, label pockets to plastic boxes and wooden pallets.

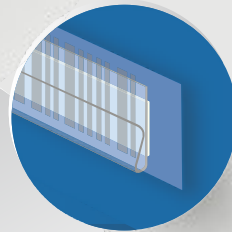

In continuo sviluppo

Continuous further development

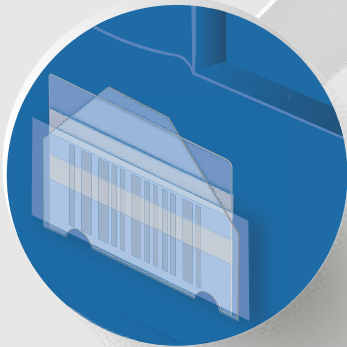

Portadocumenti

In materiale trasparente, PVC rigido resistente ai raggi UV con due strisce adesive per il fissaggio permanente a tutti i tipi di contenitori come scatole di plastica, ecc. I bordi anteriori smussati consentono un facile inserimento e rimozione delle etichette.

Label cover / document holder

Self-adhesive document holder made of transparent, UV-resistant PVC with two adhesive strips for permanent attachment to containers of any kind, e.g. Plastic boxes etc. The chamfered front edge allows for easy insertion and removal of labels.

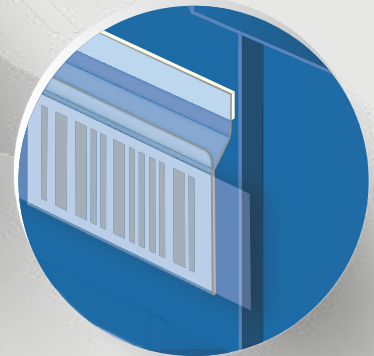

Porta etichette

Facile etichettatura di casse di plastica. L'angolazione rende l'inserimento dei documenti un gioco da ragazzi. Il robusto adesivo in schiuma aderisce saldamente a quasi tutte le superfici.

Label holder

Document holder made of transparent, UV-resistant PVC, for hanging over euroboxes, plastic boxes etc. The transparent viewing window is scanner-readable, the chamfered front edge allows for easy insertion and removal of labels.

KANBAN-Cover magnetico / adesivo

KANBAN-Cover magnetic / self-adhesive

Questi portadocumenti adesivi o magnetici sono realizzati in plastica trasparente applicabile a contenitori e scatole di plastica, contenitori metallici, ecc.

- Facile rimozione e inserimento di documenti grazie al bordo anteriore smussato
- Può essere scansionato e resistente ai raggi UV

These self-adhesive or magnetic document holders are made of transparent plastic that attaches to containers, plastic boxes, metal containers, etc.

- Easy removal and insertion of documents with beveled front edge
- Can be scanned and UV-resistant





KANBAN-Cover / KANBAN-Cover

Formato <i>Format</i>	Cod. <i>Item-No.</i>	Versione <i>Type</i>	Confezione <i>Pack</i>
DIN A7	KAN-COSA7	adesiva / <i>self-adhesive</i>	10 pezzi / <i>pieces</i>
DIN A6	KAN-COSA6	adesiva / <i>self-adhesive</i>	10 pezzi / <i>pieces</i>
DIN A5	KAN-COSA5	adesiva / <i>self-adhesive</i>	10 pezzi / <i>pieces</i>
1/4 DIN (220 x 80 mm)	KAN-COS1/4DIN	adesiva / <i>self-adhesive</i>	10 pezzi / <i>pieces</i>
EC (85 x 62 mm)	KAN-COS-EC	adesiva / <i>self-adhesive</i>	10 pezzi / <i>pieces</i>
DIN A7	KAN-COMA7	magnetica / <i>magnetic</i>	10 pezzi / <i>pieces</i>
DIN A6	KAN-COMA6	magnetica / <i>magnetic</i>	10 pezzi / <i>pieces</i>
DIN A5	KAN-COMA5	magnetica / <i>magnetic</i>	10 pezzi / <i>pieces</i>
1/4 DIN (220 x 80 mm)	KAN-COM1/4DIN	magnetica / <i>magnetic</i>	10 pezzi / <i>pieces</i>
EC (85 x 62 mm)	KAN-COM-EC	magnetica / <i>magnetic</i>	10 pezzi / <i>pieces</i>

KANBAN-Cover per sospensione

KANBAN-Cover overhang

KANBAN-Cover in PVC rigido trasparente, da appendere sul bordo di contenitori Euro, scatole di plastica, ecc.

Documento leggibile con scanner, il bordo anteriore inclinato facilita l'inserimento e l'estrazione del documento.

- I contenitori rimangono impilabili
- Resistente ai raggi UV
- Buon effetto di serraggio
- Buona maneggevolezza
- Documento scansionabile

Label holder made from transparent, UV-resistant PVC. Suitable for Kanban cards for hanging over euroboxes, plastic crates, etc. The transparent window is scanner legible. The chamfered front edge allows for easy insertion and removal of labels.

- Containers remain stackable
- UV resistant
- Good clamping effect
- Easy to use
- Scanner readable QR code / barcode



ORGATEX®



KANBAN-Cover / KANBAN-Cover

Formato <i>Format</i>	Dimensione (LxHxP) (mm) <i>Dimension (WxHxD) (mm)</i>	Cod. <i>Item-No.</i>	Confezione <i>Pack</i>
1/4 DIN	215 x 80 x 17	KAN-COW1/4DIN	10 pezzi / <i>pieces</i>
DIN A5	215 x 155 x 17	KAN-COWA5	10 pezzi / <i>pieces</i>
DIN A6	155 x 110 x 17	KAN-COWA6	10 pezzi / <i>pieces</i>
DIN A7	110 x 80 x 17	KAN-COWA7	10 pezzi / <i>pieces</i>
-	87 x 55 x 17	KAN-COW-EC	10 pezzi / <i>pieces</i>

Disponibile versione ESD a pag. 258
ESD version available at pag. 258

KANBAN Cover-Angolato

KAN-COPA Document Holder

Kanban-Cover di plastica trasparente con supporto a 90°. Indicato in particolare per imballi o prodotti sovrapposti gli uni sugli altri.

- Documento scansionabile
- Resistente ai raggi UV
- Semplice e veloce

Documents holders made of transparent hard PVC with a 90° angled tuck in flap. Especially suited to labeling of cardboard containers or stacked products.

- Scanner readable QRcode / barcode
- UV-resistant
- Good handling



ORGATEX®



KAN-COPA / KAN-COPA

Formato DIN <i>Format</i>	Dimensione (LxH) (mm) <i>Dimension (WxH) (mm)</i>	Cod. <i>Item-No.</i>	Confezione <i>Pack</i>
DIN A5	210 x 148	KAN-COPA5	10 pezzi / <i>pieces</i>
DIN A6	148 x 105	KAN-COPA6	10 pezzi / <i>pieces</i>
DIN A7	105 x 74	KAN-COPA7	10 pezzi / <i>pieces</i>
1/4 DIN	220 x 80	KAN-COP1/4DIN	10 pezzi / <i>pieces</i>

KANBAN-Cover MEGA

KANBAN-Cover MEGA

Indicato per il riconoscimento di componenti sfusi.
È la soluzione ideale nel caso di contenitori senza sede per porta etichette.

- Materiale satinato (nessun riflesso)
- Estremamente robusto
- Resistente ai graffi
- Compatibile con Systembox
- Buona leggibilità dei documenti / carte Kanban

the Kanban card holder provides the right solution thanks to its own weight. Can be used for example for marking materials/goods as 'checked' or 'blocked', or as a carrier for Kanban cards, and can also be used in all Kanban or Heijunka boards.

- Frosted material (no reflection)
- Extremely robust
- Scratch-resistant
- Compatible with Systembox
- Good legibility of documents / Kanban cards

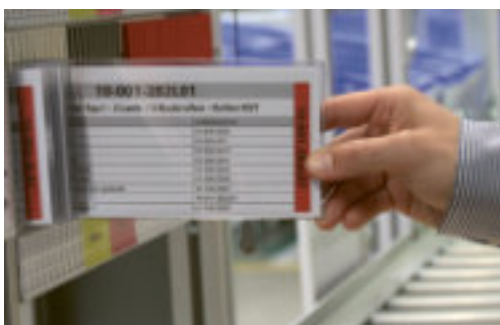



KANBAN-Cover MEGA / KANBAN-Cover MEGA

Dimensione (LxH) (mm)
Dimension (WxH) (mm)

215 x 100

Cod.
Item-No.

KAN-C01/3DIN

Confezione
Pack

10 pezzi / pieces

Label-Cover adesivo

Label-Cover self-adhesive

Portadocumenti in plastica PVC rigida con doppia striscia adesiva trasparente e fori inferiori per agevolare la rimozione del cartellino. Ideale per il fissaggio su casse in plastica, contenitori metallici, ecc

- Scansionabile e resistente ai raggi UV

With two high-performance adhesive strips on the back, especially suitable for containers with smooth sides.

The raised front makes it easier to insert / remove documents.

- Can be scanned and UV-resistant



ORGATEX®



Label-Cover / Label-Cover

Formato <i>Format</i>	Cod. <i>Item-No.</i>	Confezione <i>Pack</i>
DIN A7	LABCOVA7-2	10 pezzi / <i>pieces</i>
DIN A6	LABCOVA6-2	10 pezzi / <i>pieces</i>
DIN A5	LABCOVA5-2	10 pezzi / <i>pieces</i>
1/4 DIN (220 x 80 mm)	LABC1/4-2	10 pezzi / <i>pieces</i>

Supporto per documenti KAN-Clip

KAN-Clip Document Holder

KAN-Clip è un prodotto universale adesivo che si può applicare su plastica, metallo, ceramica, ecc.

Permette di implementare il sistema Kanban senza sostituire i contenitori già presenti in azienda anche se sprovvisti di scomparto portadocumenti.

- Adesivo ultrasensibile
- Resistente ai lavaggi
- Aderisce su quasi ogni superficie

Document Clamp with foam adhesive on the back for mounting of material cards, product information and label pockets at plastic boxes and wooden pallets, on even and uneven surfaces, plastics, aluminium, wood-type surfaces, glass and ceramics, precious and pure metals or multi-layer coated surfaces.

- Easy labeling of boxes and containers
- Excellent labeling for pallet feet
- Self-adhesive on nearly every surface





KAN-Clip / *KAN-Clip*

Dimensione (LxH) (mm)
Dimension (WxH) (mm)

75 x 31

Cod.
Item-No.

KAN-CLIP75

Confezione
Pack

100 pezzi / *pieces*

Porta etichette adesivo

Label Holder self-adhesive

Prodotto studiato per implementare i porta Kanban su contenitori non KLT. La sua forma permette un ottimo posizionamento del KANBAN esternamente rispetto alle nervature dei contenitori.

- Tiene saldamente in posizione l'etichetta
- A prova di polvere
- Può essere scansionato
- Resistente ai raggi UV
- Facile da usare
- Molto facile inserire o recuperare le etichette

Document Clip with foam adhesive on the back to allow mounting of material cards, product information and label pocket on plastic boxes. Profile for insertion, made of transparent hard PVC.

- Holds the label firmly in place
- Dust-proof
- Can be scanned
- UV resistant
- Easy to use
- Very easy to insert or retrieve the labels



ORGATEX®



Porta etichette adesivo / *Label Holder self-adhesive*

Dimensione (LxHxP) (mm)
Dimension (WxHxL) (mm)

Cod.
Item-No.

Confezione
Pack

61 x 100 x 14

KAN-COSW100-60

100 pezzi / *pieces*

Pinza per pallet

Pallet clamp Label Holder

La pinza integrata al portacartoncino frontale garantisce la perfetta tenuta del cartoncino.

- Etichetta di riconoscimento su 3 lati
- Profili di bloccaggio integrati
- Eccellente effetto di bloccaggio
- PVC resistente e robusto
- Colore giallo

For easy labeling of pallets.

The integrated clamp profiles on the front ensure perfect hold for material cards and any kind of label.

- *Ribbed side ensures ergonomic single-hand operation*
- *Integrated clamping profiles*
- *Excellent clamping effect*
- *Durable and robust PVC*
- *Signal color in yellow*





Pinza per pallet / Pallet Clamp

Opzione <i>Designation</i>	Cod. <i>Item-No.</i>	Dimensione (LxHxP) (mm) <i>Dimension (WxHxD) (mm)</i>	Confezione <i>Pack</i>
Pinza per pallet / Pallet clamp	KAN-PS2-04	100 x 74 x 145	20 pezzi / pieces
Plastica protettiva lato corto / Label Holder transparent short side	KAN-PS2-HE100	100 x 2,5 x 70	20 pezzi / pieces
Plastica protettiva lato lungo / Label Holder transparent long side	KAN-PS2-HE150	150 x 2,5 x 70	40 pezzi / pieces
Cartoncino lato corto / Cardboards short side	ET600	100 x 67	80 pezzi / pieces
Cartoncino lato lungo / Cardboards long side	ET650	150 x 67	40 pezzi / pieces

Porta Kanban KLT-Snapper

KLT-Snapper KANBAN Envelopes

Porta kanban in materiale plastico. Un sistema veloce per proteggere i Vs cartellini kanban. Con dimensioni adatte a contenitori KLT.

- Disponibili cartoncini pretagliati
- Scansionabile per lettore codice a barre
- VDA-Norm 4902
- Apertura superiore

Easy to insert, secure grip also under extreme situations. Available in various colors.

- Inserts available in customized sizes
- Can be scanned
- VDA standard 4902
- Top opening

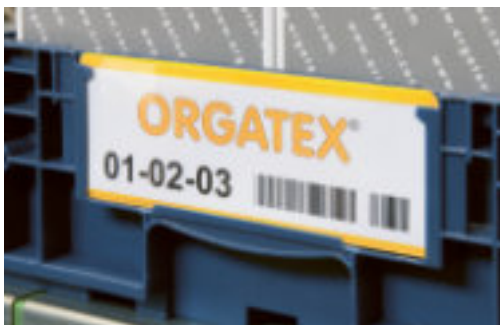



Porta Kanban KLT-Snapper / *KLT-Snapper*

Cod. <i>Item-No.</i>	+ Colore <i>+ Color</i>	Dimensioni int. / est. (LxH) (mm) <i>Inner / outer dim. (WxH) (mm)</i>	Cartoncino <i>Cardboard</i>	Confezione <i>Pack</i>
KLT-SNAP-	01 02 03 04 05 06 07 08 20	200 x 67 / 209 x 80	ET670	50 pezzi / <i>pieces</i>
KLT-SNAP-1/3DIN-	01 02 03 04 05 06 07 08 20	200 x 85 / 209 x 99	ET85	50 pezzi / <i>pieces</i>
KLT-SNAP-DINA5-	01 02 03 04 05 06 07 08 20	200 x 135 / 209 x 147	ET135	50 pezzi / <i>pieces</i>

Disponibile versione ESD a pag. 258
ESD version available at pag. 258

Cartellini a pag. 110 / *Cardboards page 110*

Porta Kanban KAN-Label

KAN-Label KANBAN Envelopes

Porta kanban in materiale plastico.

Un sistema veloce per proteggere i vostri cartellini Kanban.

Con dimensioni adatte per contenitori KLT.

- VDA-Norm 4902
- Scansionabile con lettore codici a barre
- Cartoncini pretagliati
- Applicabile su contenitori KLT e lavagne KANBAN
- Apertura laterale

A special durable version of our label holders. Three sides are closed. Cardboard labels can be inserted from one side only, thus protecting documents from dirt and moisture.

- *Printable / inscribable cardboard labels are available in compatible sizes*
- *Can be scanned*
- *For inserting in Kanban Boards*
- *Fits KLT containers and Kanban Boards*
- *Side opening*





KAN-Label / *KAN-Label*

Cod. <i>Item-No.</i>	+ Colore <i>+ Color</i>	Dimensioni int. / est. (LxH) (mm) <i>Inner / outer dim. (WxH) (mm)</i>	Cartoncino <i>Cardboard</i>	Confezione <i>Pack</i>
KL100-	01 02 03 04 05 06 07 08 20	200 x 67 / 209 x 74	ET670	50 pezzi / <i>pieces</i>
KAN-LABEL1/3DIN-	01 02 03 04 05 06 07 08 20	200 x 85 / 209 x 99	ET85	50 pezzi / <i>pieces</i>
KAN-LABELA5-	01 02 03 04 05 06 07 08 20	200 x 135 / 209 x 147	ET135	50 pezzi / <i>pieces</i>

Disponibile versione ESD a pag. 258
ESD version available at pag. 258

Cartoncini a pag. 110 / *Cardboards page 110*

Porta Kanban KAN-Label magnetico

KLMU KANBAN Envelopes

Porta kanban in materiale plastico. Un sistema veloce per proteggere i vostri cartellini Kanban ed applicarli direttamente ai contenitori metallici. Studiati per un veloce recupero dalla lavagna Kanban grazie ai magneti Neodym che si attraggono a vicenda.

- Adatto per contenitori metallici
- Scansionabile con lettore codice a barre
- Magneti Neodym
- Disponibili cartoncini pretagliati
- Apertura laterale

The two neodymium magnets welded into the top part enable the Kanban cover to also be securely fixed to non-flat or round surfaces (drums / spools).

- Magnets with very high magnetic strength
- Scanner readable Qrcode / barcode
- Suitable for VDA document holder
- Cardboard inserts deliverable in required size
- Side opening



ORGATEX®



KAN-Label magnetico / KLMU

Cod. Item-No.	+ Colore + Color	Dimensioni int. / est. (LxH) (mm) Inner / outer dim. (WxH) (mm)	Cartoncino Cardboard	Confezione Pack
KLMU100-	01 02 03 04 05 06 07 08 20	200 x 67 / 210 x 85	ET670	50 pezzi / pieces

Cartoncini a pag. 110 / Cardboards page 110

Porta Kanban KAN-Special

KNTA KANBAN Envelopes

Porta kanban in materiale plastico. Lo stesso design dei Porta Kanban ma dotati di apertura che permette di raccoglierli su un supporto a muro.

- Disponibili cartoncini pretagliati
- Scansionabile con lettore barcode
- Apertura superiore

Similar to KAN-Label, Kanban Envelopes, with a slot cut-out in the header designed for hanging.

- Printable / inscribable cardboard labels are available in compatible sizes
- Can be scanned

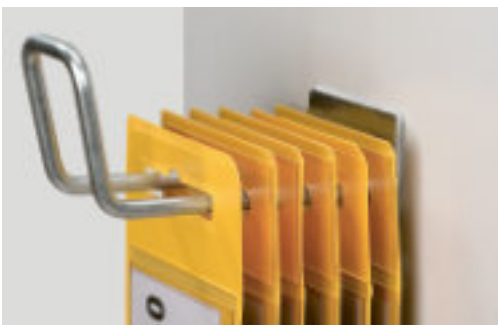



KAN-Special / *KNTA*

Cod. <i>Item-No.</i>	+ Colore <i>+ Color</i>	Dimensioni int. / est. (LxH) (mm) <i>Inner / outer dim. (WxH) (mm)</i>	Cartoncino <i>Cardboards</i>	Confezione <i>Pack</i>
KNTA-		150 x 67 / 209 x 85	ET650	50 pezzi / <i>pieces</i>

Cartoncini a pag. 110 / *Cardboards page 110*

Staffa a muro per raccolta KAN-Special / *KNTA bracket*

Cod.
Item-No.

KNTA-HALTER

Staffa da muro per KAN- Special / *Wall bracket for KAN-Special*

Identificazione scaffalature

Storage Labeling

La ricerca è finita:
con un sistema di
coordinate e le nostre
soluzioni di etichettatura,
tutto nel magazzino trova il
suo posto in modo chiaro

Ridurre il tempo di ricerca in magazzino è indispensabile con le odierne esigenze delle aziende. Un sistema di coordinate come base per l'assegnazione chiara delle merci ai luoghi di stoccaggio può essere d'aiuto. Le coordinate del posizionamento forniscono una chiave numerica ben congegnata che garantisce una chiara determinazione della locazione nel magazzino. Affinché questo sistema funzioni nella pratica, tuttavia, è necessaria un'etichettatura ottimale: etichette ben visibili su file di scaffali, scomparti e livelli di parcheggio. LeanProducts srl può fornirti la giusta soluzione di marcatura per tutte le aree e gli scopi: magnetica o autoadesiva, colorata o trasparente, per fissaggio permanente o temporaneo. I nostri porta documenti adesivi sono particolarmente adatti per posizioni di stoccaggio fisse con articoli variabili. Grazie all'adesivo in schiuma si attaccano facilmente a scaffali,

pallet e contenitori. Abbiamo progettato tutte le varianti in modo che i documenti possano essere inseriti e scambiati senza sforzo. Grazie alla pellicola trasparente frontale anche la scansione senza errori dei codici a barre non è un problema. Anche i sistemi di scaffalature tubolari possono essere chiaramente contrassegnati con i nostri porta etichette adatti al profilo tondo. Anche gli urti dei carrelli elevatori non sono un problema: la flessibilità dei supporti del Flexschild gli permette di tornare semplicemente nella sua posizione originale.

*The search is over:
with the coordinate
system and our labeling
solutions, everything
finds its place in the
warehouse*

Hours spent searching for things in the warehouse are unthinkable when taking today's demands on companies into consideration. We have developed a coordinate system as the basis for the clear assignment of goods to storage spaces. A well thought-out number key is the result of the coordinates in a storage space and thus ensures a clear spatial determination.

In order for this system to work in practice, optimal labeling is required: clearly visible labels on rows of shelves, shelves and storage space levels.

You will find the right labeling for all areas and purposes: whether magnetic or self-adhesive, whether colored or transparent, whether for permanent or temporary installation.

Our self-adhesive Quick-Label insert signs are particularly suitable for fixed storage spaces and variable items. Using a foam adhesive, they adhere easily to shelves, pallets and containers. Our magnetic bearing

plates are used for metal surfaces. We have designed all variants in a way that documents can be inserted and exchanged effortlessly. Thanks to the transparent clear view profile, error-free scanning of barcodes is also no problem.

Tube and round rack system can also be clearly identified by our round tube label holder. And our flex sign shows its strengths with high loads - even managing forklift impacts: it simply springs back to its initial position.



Porta etichette magnetico standard
Label Holders transparent



Label Top magnetico e adesivo
Label Holders coloured



Etichette magnetiche scrivibili
Magnetic signs / tapes coloured

Identificazione scaffalature

Infographic Storage Labeling

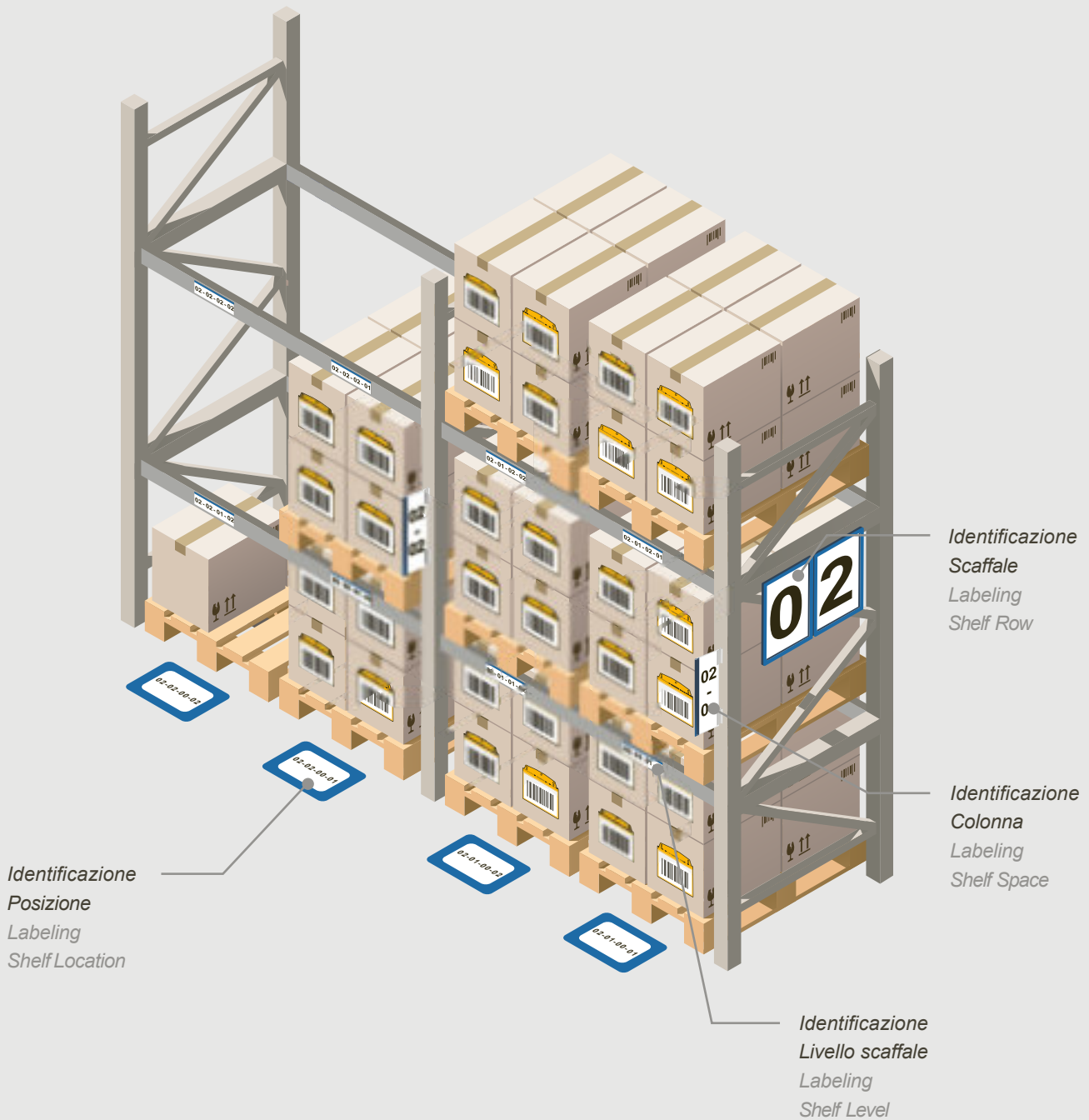

Applicabile ad ogni
contenitore
*Suitable for all
containers*



Per etichette rimovibili
o fisse
*For flexible or
permanent labeling*

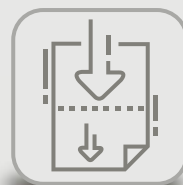

Cartoncino pretagliato
per una stampa precisa
*Pre-punched cardboards
to ensure precise printing*



Cornice per sospensione

Offre una grande visibilità. Le cornici possono essere combinate tra loro per formare strutture complesse.

Poster Frames (Shelf Row)

Labeling on the front offers high visibility.

Poster frames can also be used as triangles.



Formati Standard

Standard Format sizes

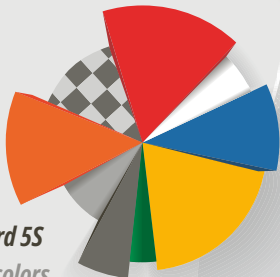

Colori standard 5S
Standard 5S colors



Porta etichette a livello scaffale

Permanente o temporanea, la marcatura può essere adesiva o magnetica.

Label Holder (Shelf Level)

Permanent or temporary, labeling can come in self-adhesive or magnetic options.

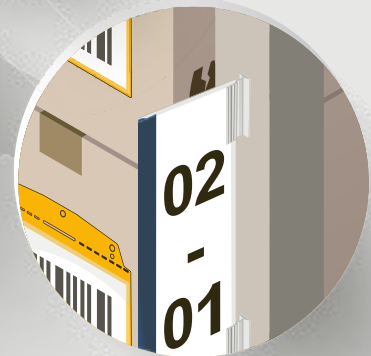

Continuo Sviluppo

Continuous further development



Schermi protettivi

La marcatura delle posizioni più basse rappresenta una sfida particolare, in quanto vi è un carico aggiuntivo da parte dei carrelli industriali. Qui lo schermo protettivo con la sua eccellente forza adesiva offre una soluzione ottimale.

Clearview Floor Frames (Shelf Location)

The labeling of the lowest storage locations is particularly challenging, as there is the additional factor of industrial forklifts to take into account. Here the transparent window (from p. 130) with its excellent grip offers an optimal solution.

Flex Shield

Visibile a grande distanza sfruttando l'angolo di 90°. Grazie alla struttura a 2 componenti, il cartello ritorna semplicemente nella sua posizione originale dopo il contatto con il pallet (stoccaggio / prelievo). Evitando danni.

Flex Sign (Shelf Space)

Specially developed to meet highly demanding applications, creates a significant long-distance visibility effect due to its 90° angle. Its 2-component construction means the sign simply springs back into its initial position after contact with the pallet (inserting/removal). Damage is thus avoided.

Porta etichette per tubolari

Rounded Label Holder

Un modo facile per rendere visibili le informazioni.

I ganci permettono il facile fissaggio e la presa sicura su strutture realizzate con qualsiasi sistema tubolare o profilato a sezione circolare di Ø 28 mm circa.

La costruzione a 2 componenti conferisce alla clip stabilità e flessibilità allo stesso tempo. Su tubi tondi o profilati, i punti di presa appositamente disposti all'interno garantiscono una presa sicura su tutto il corpo.

Due to its ergonomic shape, the label holder forms a unit with the profile or tube. The stable transparent profile is open at the sides and at the top, making it easy to replace the matching cardboard inserts.

The 2-component construction gives the clip stability and flexibility at the same time.

On round tubes or profiled tubes, specially arranged grip points on the inside provide all-over secure hold.



Porta etichette con ganci / *Rounded Label Holder*

	Formato (L) (mm) <i>Dimension (W) (mm)</i>	Cod. <i>Item-No.</i>	N. Ganci per pezzo <i>Gripper per piece</i>	Confezione <i>Pack</i>
	100	VST-LABEL-100	2	50 pezzi / <i>pieces</i>
	200	VST-LABEL-200	2	50 pezzi / <i>pieces</i>
	300	VST-LABEL-300	3	50 pezzi / <i>pieces</i>
	400	VST-LABEL-400	3	50 pezzi / <i>pieces</i>
	1000	VST-LABEL-1000	4	50 pezzi / <i>pieces</i>
	Ganci / Hook	VST-GRIPPER	-	50 pezzi / <i>pieces</i>

Porta cartellino frontale / *Front label holder*

	Dimensione (LxH) (mm) <i>Dimension (WxH) (mm)</i>	Cod. <i>Item-No.</i>	Confezione <i>Pack</i>
	120 x 53	GF28-PH120	1 pezzo / <i>piece</i>
<p>Porta cartellino in plastica trasparente con aggancio posteriore per sistema tubolare o profilato a sezione circolare Ø 28 mm.</p>		<p><i>Transparent PVC tag holder open on three sides with rear attachment and front label positioning. For identification on shelves made with tubular or profiled system Ø 28 mm approx.</i></p>	

Portaetichette adesivo / *Adhesive clip*

	Dimensione (LxH) (mm) <i>Dimensions (WxH) (mm)</i>	Cod. <i>Item-No.</i>	Confezione <i>Pack</i>
	2000 x 38	GF28-382000PVC	1 pezzo / <i>piece</i>
	102 x 38	GF28-38102PVC	1 pezzo / <i>piece</i>
	<p>Porta etichetta adesivo in PVC trasparente, H=38 mm, permette di esporre cartellini identificativi su qualsiasi scaffale in tubolare o profilo Ø 28 mm.</p>		<p><i>Adhesive label holder in transparent PVC, H=38 mm, allows to display identification tags on any shelf in tubular or profile Ø 28 mm.</i></p>

Portaetichette adesivo curvo / *Curved adhesive clip*

	Dimensione (L) (mm) <i>Dimension (W) (mm)</i>	Cod. <i>Item-No.</i>	Confezione <i>Pack</i>
	2000	GF28-2000PVC	1 pezzo / <i>piece</i>
	102	GF28-102PVC	1 pezzo / <i>piece</i>
	<p>Porta etichetta adesivo curvo in PVC trasparente, permette di esporre cartellini identificativi su qualsiasi scaffale in tubolare o profilo Ø 28 mm.</p>		<p><i>Curved adhesive label holder in transparent PVC, allows to display identification tags on any shelf in tubular or profile Ø 28 mm.</i></p>

Portaetichette magnetico / adesivo

Label Holders magnetic / self-adhesive

L'apertura su 3 lati permette di inserire e sostituire facilmente i cartoncini. In plastica rigida, sono disponibili in versione con adesivo in schiuma o con superficie totalmente magnetica. Il fronte trasparente consente la scansione dei codici a barre senza errori.

The sturdy transparent profile is open at the sides and at the top. Not only can suitable cardboard inserts be easily inserted and exchanged, but also larger documents, accompanying documents or additional information are always at hand. The sturdy label holders are equipped with a foam adhesive on the back or with a full-surface magnetic strip. The transparent profile enables error-free scanning of barcodes.



Dimensioni esterne (mm)
Outer dimensions (mm)

A	20	27	38	47	67
B	75	75	75	75	100
B	100	100	100	100	150
B	150	150	150	150	200

ORGATEX[®]



Porta etichette magnetici / adesivi

Label Holders magnetic / self-adhesive

Porta etichette magnetico - Standard / *Label Holders magnetic*

	Dimensione (H x L) (mm) <i>Dimension (H x W) (mm)</i>	Cod. <i>Item-No.</i>	Cartoncino <i>Cardboards</i>	Confezione <i>Pack</i>
	20 x 75	HE120-75	ET190	100 pezzi / <i>pieces</i>
	20 x 100	HE120-100	ET210	100 pezzi / <i>pieces</i>
	20 x 150	HE120-150	ET220	100 pezzi / <i>pieces</i>
	25 x 75	HE125-75	ET230	100 pezzi / <i>pieces</i>
	25 x 100	HE125-100	ET200	100 pezzi / <i>pieces</i>
	25 x 150	HE125-150	ET250	100 pezzi / <i>pieces</i>
	27 x 75	HE127-75	ET75	100 pezzi / <i>pieces</i>
	27 x 100	HE127-100	ET100	100 pezzi / <i>pieces</i>
	27 x 150	HE127-150	ET150	100 pezzi / <i>pieces</i>
	38 x 75	HE138-75	ET375	100 pezzi / <i>pieces</i>
	38 x 100	HE138-100	ET300	100 pezzi / <i>pieces</i>
	38 x 150	HE138-150	ET350	100 pezzi / <i>pieces</i>
	47 x 75	HE147-75	ET475	100 pezzi / <i>pieces</i>
	47 x 100	HE147-100	ET400	100 pezzi / <i>pieces</i>
	47 x 150	HE147-150	ET450	100 pezzi / <i>pieces</i>
	50 x 100	HE150-100	ET500	100 pezzi / <i>pieces</i>
	50 x 150	HE150-150	ET550	100 pezzi / <i>pieces</i>
67 x 100	HE167-100	ET600	100 pezzi / <i>pieces</i>	
67 x 150	HE167-150	ET650	100 pezzi / <i>pieces</i>	
67 x 200	HE167-200	ET670	100 pezzi / <i>pieces</i>	

Cartoncini a pag. 110 / *Cardboard labels page 110*

Porta etichette adesivo - Quick Label / *Label Holders self-adhesive*

	Dimensione (H x L) (mm) <i>Dimension (H x W) (mm)</i>	Cod. <i>Item-No.</i>	Cartoncino <i>Cardboards</i>	Confezione <i>Pack</i>
	20 x 75	SL020-75	ET190	100 pezzi / <i>pieces</i>
	20 x 100	SL020-100	ET210	100 pezzi / <i>pieces</i>
	20 x 150	SL020-150	ET220	100 pezzi / <i>pieces</i>
	27 x 75	SL027-75	ET75	100 pezzi / <i>pieces</i>
	27 x 100	SL027-100	ET100	100 pezzi / <i>pieces</i>
	27 x 150	SL027-150	ET150	100 pezzi / <i>pieces</i>
	38 x 75	SL038-75	ET375	100 pezzi / <i>pieces</i>
	38 x 100	SL038-100	ET300	100 pezzi / <i>pieces</i>
	38 x 150	SL038-150	ET350	100 pezzi / <i>pieces</i>
	47 x 75	SL047-75	ET475	100 pezzi / <i>pieces</i>
	47 x 100	SL047-100	ET400	100 pezzi / <i>pieces</i>
	47 x 150	SL047-150	ET450	100 pezzi / <i>pieces</i>
	67 x 100	SL067-100	ET600	100 pezzi / <i>pieces</i>
	67 x 150	SL067-150	ET650	100 pezzi / <i>pieces</i>
	67 x 200	SL067-200	ET670	100 pezzi / <i>pieces</i>
	67 x 300	SL067-300	-	100 pezzi / <i>pieces</i>
	27 x 600	SL027-600	-	50 pezzi / <i>pieces</i>
	47 x 600	SL047-600	-	50 pezzi / <i>pieces</i>
	67 x 600	SL067-600	-	50 pezzi / <i>pieces</i>

Cartoncini a pag. 110 / *Cardboards page 110*



Porta etichette magnetico - Color

Color Label Holders magnetic

Similare ai porta etichette standard ma con fascia colorata superiore di 10 mm d'altezza.

Il magnete su tutta la superficie posteriore e il numero di formati permettono una facile applicazione su scaffali di tutte le dimensioni.

Standard Label Holder with a 10 mm colored top edge. The entire back surface of the Label Holder is magnetic. By colored labeling single product groups or subject areas can be differentiated easily.

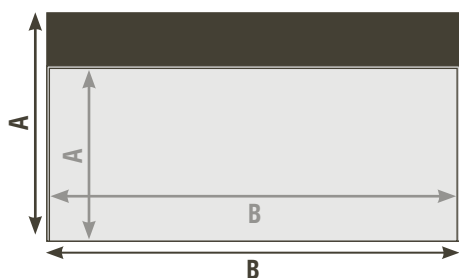

Dimensioni esterne (mm) / interne (mm)

Existing formats in mm outer dimensions (mm) / inner dimensions (mm)

A	35 / 25	48 / 38	60 / 50
B	100 / 100	100 / 100	100 / 100
B	150 / 150	150 / 150	150 / 150

ORGATEX[®]



Porta etichette magnetico - Color

Color Label Holders magnetic

Porta etichette magnetico - Color / Color

	Dimensione (H x L) (mm) <i>Dimension (H x W) (mm)</i>	Cod. <i>Item-No.</i>	+ Colore <i>+ Color</i>					Cartoncino <i>Cardboards</i>	Confezione <i>Pack</i>
			01	02	03	04	05		
	35 x 100	HE225-100/	01	02	03	04	05	ET200	100 pezzi / <i>pieces</i>
	35 x 150	HE225-150/	01	02	03	04	05	ET250	100 pezzi / <i>pieces</i>
	48 x 100	HE238-100/	01	02	03	04	05	ET 300	100 pezzi / <i>pieces</i>
	48 x 150	HE238-150/	01	02	03	04	05	ET 350	100 pezzi / <i>pieces</i>
	60 x 100	HE250-100/	01	02	03	04	05	ET 500	100 pezzi / <i>pieces</i>
	60 x 150	HE250-150/	01	02	03	04	05	ET 550	100 pezzi / <i>pieces</i>

Cartoncini a pag. 110 / *Cardboards page 110*

ORGATEX®



Porta etichette Label Top magnetico / adesivo

Label Top Label Holders magnetic / self-adhesive

Porta etichette per cartoncini. L'apertura superiore e laterale permette di inserire cartoncini anche più grandi delle dimensioni proposte.

Scansionabile con lettore codice a barre.

Label Pocket for inserts. Opens at both sides and at the top for easy insertion of fitted or bigger documents or additional information.

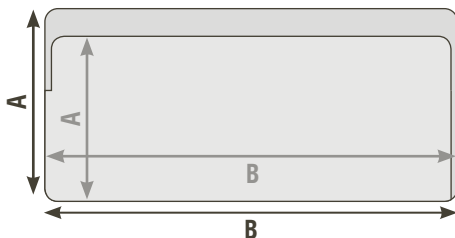

Dimensioni esterne (mm) / interne (mm)

Existing formats in mm outer dimensions (mm) / inner dimensions (mm)

A	35 / 25	50 / 38	80 / 67
B	107 / 100	107 / 100	160 / 100

ORGATEX®



Label Top magnetico / adesivo

Label Top magnetic / self-adhesive

Label Top con 1 striscia magnetica / Label Top 1 Magnetic strip

	Dimensioni int. / est. (HxL) Inner / outer dim. (HxW)	Cod. Item-No.	+ Colore + Color	Cartoncino Cardboards	Confezione Pack
	25 x 100 / 35 x 107 (mm)	LTM110-35/	01 02 03 04 05 06 07 08	ET200	50 pezzi / pieces
	38 x 100 / 50 x 107 (mm)	LTM110-50/	01 02 03 04 05 06 07 08	ET300	50 pezzi / pieces
	67 x 150 / 80 x 160 (mm)	LTM160-80/	01 02 03 04 05 06 07 08	ET650	50 pezzi / pieces

Label Top con 2 strisce magnetiche / Label Top 2 Magnetic strips

	Dimensioni int. / est. (HxL) Inner / outer dim. (HxW)	Cod. Item-No.	+ Colore + Color	Cartoncino Cardboards	Confezione Pack
	67 x 150 / 80 x 160 (mm)	LTV160-80/	01 02 03 04 05 06 07 08	ET650	50 pezzi / pieces

Label Top adesivo / Label Top 1 Foam adhesive strip

	Dimensioni int. / est. (HxL) Inner / outer dim. (HxW)	Cod. Item-No.	+ Colore + Color	Cartoncino Cardboards	Confezione Pack
	25 x 100 / 35 x 107 (mm)	LTS110-35/	01 02 03 04 05 06 07 08	ET200	50 pezzi / pieces
	38 x 100 / 50 x 107 (mm)	LTS110-50/	01 02 03 04 05 06 07 08	ET300	50 pezzi / pieces
	67 x 150 / 80 x 160 (mm)	LTS160-80/	01 02 03 04 05 06 07 08	ET650	50 pezzi / pieces

Cartoncini a pag. 110 / Cardboards page 110

ORGATEX[®]



Porta etichette Label Plus magnetico / adesivo

Label Plus Label Holders magnetic / self-adhesive

Disponibile in diversi colori e formati, con apertura superiore.

La tasca può contenere anche più cartoncini.

Scansionabile con lettore codice a barre.

Colored label holders, available in magnetic or self-adhesive versions. Label Plus is open on the upper side. Labels are easy to insert and are securely held.

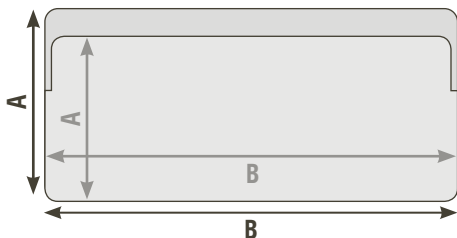

Dimensioni esterne (mm) / interna (mm)

Existing formats in mm outer dimensions (mm) / inner dimensions (mm)

A	35 / 25	50 / 38	80 / 67
B	107 / 100	107 / 100	160 / 150

ORGATEX®



Label Plus magnetico / adesivo

Label Plus magnetic / self-adhesive

Label Plus con 1 striscia magnetica / Label Plus 1 Magnetic strip

	Dimensioni int. / est. (HxL) Inner / outer dim. (HxW)	Cod. Item-No.	+ Colore + Color	Cartoncino Cardboards	Confezione Pack
	25 x 100 / 35 x 107 (mm)	LPM110-35/	01 02 03 04 05 06 07 08	ET200	50 pezzi / pieces
	38 x 100 / 50 x 107 (mm)	LPM110-50/	01 02 03 04 05 06 07 08	ET300	50 pezzi / pieces
	67 x 150 / 80 x 160 (mm)	LPM160-80/	01 02 03 04 05 06 07 08	ET650	50 pezzi / pieces

Label Plus con 2 strisce magnetiche / Label Plus 2 Magnetic strips

	Dimensioni int. / est. (HxL) Inner / outer dim. (HxW)	Cod. Item-No.	+ Colore + Color	Cartoncino Cardboards	Confezione Pack
	67 x 150 / 80 x 160 (mm)	LPV160-80/	01 02 03 04 05 06 07 08	ET650	50 pezzi / pieces

Label Plus adesivo / Label Plus 1 Foam adhesive strip

	Dimensioni int. / est. (HxL) Inner / outer dim. (HxW)	Cod. Item-No.	+ Colore + Color	Cartoncino Cardboards	Confezione Pack
	25 x 100 / 35 x 107 (mm)	LPS110-35/	01 02 03 04 05 06 07 08	ET200	50 pezzi / pieces
	38 x 100 / 50 x 107 (mm)	LPS110-50/	01 02 03 04 05 06 07 08	ET300	50 pezzi / pieces
	67 x 150 / 80 x 160 (mm)	LPS160-80/	01 02 03 04 05 06 07 08	ET650	50 pezzi / pieces

Cartoncini a pag. 110 / Cardboards page 110

ORGATEX[®]



Porta etichette MEGA magnetico /adesivo

MEGA Label Holders magnetic / self-adhesive

I porta etichette MEGA sono in plastica resistente, con fronte trasparente, saldatura superiore e inferiore; l'inserimento del cartoncino può facilmente avvenire dal lato sinistro o destro.

Magnetic and self-adhesive Label Holders - Mega type are made of extremely durable plastic with transparent front, heat-sealed top and bottom. Compatible cardboard labels can be inserted easily from either side.



Dimensioni esterne (mm)

External dimensions (mm)

A	60	80
B	100	100
B	150	150
B	200	200
B	300	300
B	600	600

ORGATEX®



Porta etichette MEGA magnetico / adesivo

MEGA Label Holders magnetic / self-adhesive

Porta etichette magnetico MEGA / MEGA magnetic

	Dimensione (HxL) (mm) Dimension (HxW) (mm)	Cod. Item-No.	+ Colore + Color	Cartoncino Cardboards	Confezione Pack
	60 x 100	HEM360-100/	01 02 03 04 05 06 07 08 20	ET500	50 pezzi / pieces
	60 x 150	HEM360-150/	01 02 03 04 05 06 07 08 20	ET550	50 pezzi / pieces
	60 x 200	HEM360-200/	01 02 03 04 05 06 07 08 20	ET520	50 pezzi / pieces
	60 x 300	HEM360-300/	01 02 03 04 05 06 07 08 20	ET700	25 pezzi / pieces
	60 x 600	HEM360-600/	01 02 03 04 05 06 07 08 20	ET730	10 pezzi / pieces
	80 x 100	HEM380-100/	01 02 03 04 05 06 07 08 20	ET600	50 pezzi / pieces
	80 x 150	HEM380-150/	01 02 03 04 05 06 07 08 20	ET650	50 pezzi / pieces
	80 x 200	HEM380-200/	01 02 03 04 05 06 07 08 20	ET670	50 pezzi / pieces
	80 x 300	HEM380-300/	01 02 03 04 05 06 07 08 20	ET800	25 pezzi / pieces
	80 x 600	HEM380-600/	01 02 03 04 05 06 07 08 20	ET830	10 pezzi / pieces

Porta etichette adesivo MEGA / MEGA self-adhesive

	Dimensione (HxL) (mm) Dimension (HxW) (mm)	Cod. Item-No.	+ Colore + Color	Cartoncino Cardboards	Confezione Pack
	60 x 100	HES460-100/	01 02 03 04 05 06 07 08 20	ET500	50 pezzi / pieces
	60 x 150	HES460-150/	01 02 03 04 05 06 07 08 20	ET550	50 pezzi / pieces
	60 x 200	HES460-200/	01 02 03 04 05 06 07 08 20	ET520	50 pezzi / pieces
	60 x 300	HES460-300/	01 02 03 04 05 06 07 08 20	ET700	25 pezzi / pieces
	60 x 600	HES460-600/	01 02 03 04 05 06 07 08 20	ET730	10 pezzi / pieces
	80 x 100	HES480-100/	01 02 03 04 05 06 07 08 20	ET600	50 pezzi / pieces
	80 x 150	HES480-150/	01 02 03 04 05 06 07 08 20	ET650	50 pezzi / pieces
	80 x 200	HES480-200/	01 02 03 04 05 06 07 08 20	ET670	50 pezzi / pieces
	80 x 300	HES480-300/	01 02 03 04 05 06 07 08 20	ET800	25 pezzi / pieces
	80 x 600	HES480-600/	01 02 03 04 05 06 07 08 20	ET830	10 pezzi / pieces

Cartoncini a pag. 110 / Cardboards page 110

Porta etichette magnetico a "C"

Magnetic "C" shape insert label

I porta etichette magnetici a "C" costituiscono il sistema più semplice e pratico per visualizzare e per spostare in caso di necessità i codici relativi alle merci. Vengono forniti completi di cartoncino bianco e di PVC trasparente protettivo e antipolvere. Fornitura in rotoli o, a richiesta, pretagliato nelle tre lunghezze standard 75 - 100 - 150 mm.

- Adatto per lettore codice a barre
- Fronte: PVC trasparente
- Retro: intera superficie magnetica
- Cartoncino incluso

Also available pre-cut on request. The "C" shaped magnetic label holders are the simplest and most practical system for displaying and moving the codes relating to the goods if necessary. They are supplied complete with white cardboard and transparent protective, dust-proof PVC. Supplied in rolls or, upon request, pre-cut in the three standard lengths 75 - 100 - 150 mm.

- Suitable for barcode reader
- Frontal face: transparent PVC
- Back face: full magnetic surface
- Cardboards included

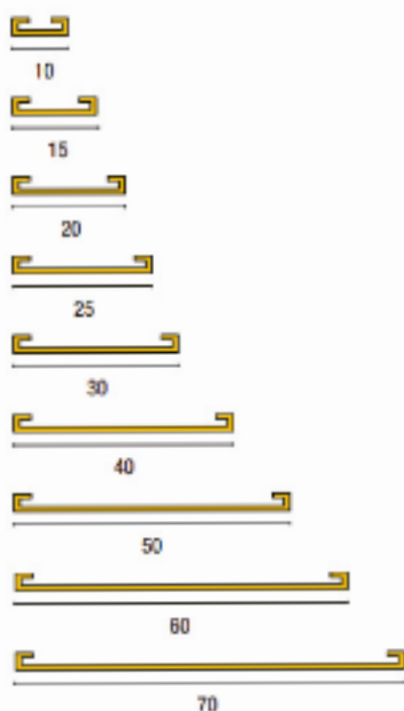

Porta etichette magnetico a "C" / Magnetic "C" shape insert label

	Dimensione (L) (mm) Dimension (W) (mm)	Cod. Item-No.	Rotolo (metri) Roll (meters)	Confezione Pack
	10	LP-C-10-50	50	1 pezzo / piece
	15	LP-C-15-50	50	1 pezzo / piece
	20	LP-C-20-50	50	1 pezzo / piece
	25	LP-C-25-50	50	1 pezzo / piece
	30	LP-C-30-50	50	1 pezzo / piece
	40	LP-C-40-50	50	1 pezzo / piece
	50	LP-C-50-50	50	1 pezzo / piece
	60	LP-C-60-25	25	1 pezzo / piece
	70	LP-C-70-25	25	1 pezzo / piece
Disponibili anche pretagliati su richiesta			Also available pre-cut in request	

Etichette magnetiche scrivibili

Magnetic Signs

Etichette magnetiche scrivibili pretagliate.

L'identificazione in magazzino è sempre aggiornata, ordinata e chiara. Cinque differenti colori per creare ulteriori distinzioni, a prima vista.

- Applicazione stabile su tutte le superfici ferrose
- Riutilizzabile
- Applicazione e rimozione facile e veloce
- Possibilità di utilizzo pennarelli indelebili per scritte permanenti (uso esterno) o pennarelli a base acqua per scritte cancellabili (Pag.249)
- Possibilità di applicazione etichette adesive prestampate

Pre-cut writable magnetic labels.

Identification in the warehouse is always up-to-date, tidy and clear. Five different colors to create more distinctions, at first sight.

- *Secure attachment on all ferrous surfaces*
- *Attached and implemented in seconds*
- *Labeling in storage areas will thus be always current and clearly arranged. Five different colors provide easy and quick orientation in storage areas.*

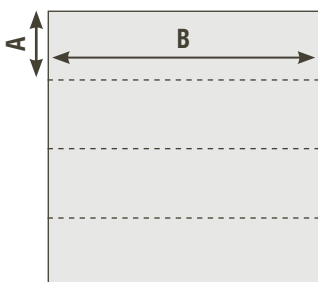

Dimensioni esterne (mm)
External dimensions (mm)

A	20	25	30	35	40	50	60	70
B	60	60	60	60	60	60	60	60
B	75	75	75	75	75	75	75	75
B	100	100	100	100	100	100	100	100
B	150	150	150	150	150	150	150	150



Etichette magnetiche scrivibili

Magnetic Signs

Etichette magnetiche scrivibili / Magnet Signs (Shelf Tapes)			
Dimensione (HxL) (mm) <i>Dimension (HxW) (mm)</i>	Cod. <i>Item-No.</i>	+ Colore <i>+ Color</i>	Confezione <i>Pack</i>
20 x 60	MR60-20/	01 02 03 04 05	100 pezzi / <i>pieces</i>
20 x 75	MR75-20/	01 02 03 04 05	100 pezzi / <i>pieces</i>
20 x 100	MR100-20/	01 02 03 04 05	100 pezzi / <i>pieces</i>
20 x 150	MR150-20/	01 02 03 04 05	100 pezzi / <i>pieces</i>
25 x 60	MR60-25/	01 02 03 04 05	100 pezzi / <i>pieces</i>
25 x 75	MR75-25/	01 02 03 04 05	100 pezzi / <i>pieces</i>
25 x 100	MR100-25/	01 02 03 04 05	100 pezzi / <i>pieces</i>
25 x 150	MR150-25/	01 02 03 04 05	100 pezzi / <i>pieces</i>
30 x 60	MR60-30/	01 02 03 04 05	100 pezzi / <i>pieces</i>
30 x 75	MR75-30/	01 02 03 04 05	100 pezzi / <i>pieces</i>
30 x 100	MR100-30/	01 02 03 04 05	100 pezzi / <i>pieces</i>
30 x 150	MR150-30/	01 02 03 04 05	100 pezzi / <i>pieces</i>
35 x 60	MR60-35/	01 02 03 04 05	100 pezzi / <i>pieces</i>
35 x 75	MR75-35/	01 02 03 04 05	100 pezzi / <i>pieces</i>
35 x 100	MR100-35/	01 02 03 04 05	100 pezzi / <i>pieces</i>
35 x 150	MR150-35/	01 02 03 04 05	100 pezzi / <i>pieces</i>
40 x 60	MR60-40/	01 02 03 04 05	100 pezzi / <i>pieces</i>
40 x 75	MR75-40/	01 02 03 04 05	100 pezzi / <i>pieces</i>
40 x 100	MR100-40/	01 02 03 04 05	100 pezzi / <i>pieces</i>
40 x 150	MR150-40/	01 02 03 04 05	100 pezzi / <i>pieces</i>
50 x 60	MR60-50/	01 02 03 04 05	100 pezzi / <i>pieces</i>
50 x 75	MR75-50/	01 02 03 04 05	100 pezzi / <i>pieces</i>
50 x 100	MR100-50/	01 02 03 04 05	100 pezzi / <i>pieces</i>
50 x 150	MR150-50/	01 02 03 04 05	100 pezzi / <i>pieces</i>
60 x 60	MR60-60/	01 02 03 04 05	100 pezzi / <i>pieces</i>
60 x 75	MR75-60/	01 02 03 04 05	100 pezzi / <i>pieces</i>
60 x 100	MR100-60/	01 02 03 04 05	100 pezzi / <i>pieces</i>
60 x 150	MR150-60/	01 02 03 04 05	100 pezzi / <i>pieces</i>
70 x 60	MR60-70/	01 02 03 04 05	100 pezzi / <i>pieces</i>
70 x 75	MR75-70/	01 02 03 04 05	100 pezzi / <i>pieces</i>
70 x 100	MR100-70/	01 02 03 04 05	100 pezzi / <i>pieces</i>
70 x 150	MR150-70/	01 02 03 04 05	100 pezzi / <i>pieces</i>

Etichette magnetiche scrivibili

Magnetic Tapes

Nastri magnetici scrivibili / *Magnetic Tapes*

	Dimensione (HxL) (mm) <i>Dimension (HxW) (mm)</i>	Cod. <i>Item-No.</i>	+ Colore <i>+ Color</i>	Confezione <i>Pack</i>
	10 x 600	MB710/	01 02 03 04 05	10 pezzi / <i>pieces</i>
	15 x 600	MB715/	01 02 03 04 05	10 pezzi / <i>pieces</i>
	20 x 600	MB720/	01 02 03 04 05	10 pezzi / <i>pieces</i>
	25 x 600	MB725/	01 02 03 04 05	10 pezzi / <i>pieces</i>
	30 x 600	MB730/	01 02 03 04 05	10 pezzi / <i>pieces</i>
	35 x 600	MB735/	01 02 03 04 05	10 pezzi / <i>pieces</i>
	40 x 600	MB740/	01 02 03 04 05	10 pezzi / <i>pieces</i>
	50 x 600	MB750/	01 02 03 04 05	10 pezzi / <i>pieces</i>
	60 x 600	MB760/	01 02 03 04 05	10 pezzi / <i>pieces</i>
	70 x 600	MB770/	01 02 03 04 05	10 pezzi / <i>pieces</i>
	75 x 600	MB775/	01 02 03 04 05	10 pezzi / <i>pieces</i>
	80 x 600	MB780/	01 02 03 04 05	10 pezzi / <i>pieces</i>
	90 x 600	MB790/	01 02 03 04 05	10 pezzi / <i>pieces</i>
100 x 600	MB800/	01 02 03 04 05	10 pezzi / <i>pieces</i>	

Fogli magnetici scrivibili / *Pre-Cut Magnetic Tapes*

	Dimensione (HxL) (mm) <i>Dimension (HxW) (mm)</i>	Cod. <i>Item-No.</i>	+ Colore <i>+ Color</i>	Confezione <i>Pack</i>
	200 x 300	R262/	01 02 03 04 05	1 pezzo / <i>piece</i>
	300 x 600	R512/	01 02 03 04 05	1 pezzo / <i>piece</i>
	400 x 600	R513/	01 02 03 04 05	1 pezzo / <i>piece</i>
	600 x 600	R514/	01 02 03 04 05	1 pezzo / <i>piece</i>
	600 x 1000	R515/	- 02 - - -	1 pezzo / <i>piece</i>
	615 x 10000	R3012/	- 02 - - -	1 pezzo / <i>piece</i>

Nastri magnetici adesivi

Magnetic Tapes self-adhesive

La superficie adesiva permette l'adesione su quasi ogni superficie. Il lato magnetico è disponibile nella versione normale (0,75 mm) ed extra-forte (2 mm) rende così l'oggetto magnetico e fissabile su superfici metalliche. Il materiale flessibile permette l'adesione anche su superfici non lisce.

- Alta capacità adesiva
- Può essere tagliato secondo le misure necessarie
- Superficie completamente magnetica
- Flessibile
- Spessore da 0,75 / 2 mm

The full-surface adhesive on the back allows non-magnetic objects, e.g. warning or information signs made of aluminum or plastic, to be attached to metal doors and gates. The flexible material allows it to be attached to non-planar surfaces such as drums or pipes.

- High adhesion
- Can be shortened with scissors or cutter knife
- Full-surface magnet
- Flexible
- Material thickness: 0,75 mm / 2 mm



 Nastri magnetici adesivi / *Magnetic Tapes self-adhesive*

Dimensione (LxH) (mm) <i>Dimension (HxW) (mm)</i>	Cod. <i>Item-No.</i>	Confezione <i>Pack</i>
20 x 600	SMB520	10 pezzi / <i>pieces</i>
25 x 600	SMB525	10 pezzi / <i>pieces</i>
30 x 600	SMB530	10 pezzi / <i>pieces</i>
35 x 600	SMB535	10 pezzi / <i>pieces</i>
40 x 600	SMB540	10 pezzi / <i>pieces</i>
50 x 600	SMB550	10 pezzi / <i>pieces</i>
60 x 600	SMB560	10 pezzi / <i>pieces</i>
70 x 600	SMB570	10 pezzi / <i>pieces</i>
75 x 600	SMB575	10 pezzi / <i>pieces</i>
80 x 600	SMB580	10 pezzi / <i>pieces</i>
100 x 600	SMB600	10 pezzi / <i>pieces</i>
25 x 600 Spessore 2 mm / <i>Thickness 2 mm</i>	SMB-EXTRA	10 pezzi / <i>pieces</i>
25 x 150 Spessore 2 mm / <i>Thickness 2 mm</i>	SMB-EXTRA/150	10 pezzi / <i>pieces</i>

Flexschild

Flex Sign self-adhesive

Componente studiato per identificare le varie posizioni nei magazzini porta pallet.

Fissaggio con due supporti adesivi flessibili e portadocumenti in PVC.

Flex Labels for shelf and storage identification.

Flexible labeling due to rigid PVC film (label returns to original position after impact). Two flex grippers, which are included in the delivery, are used to mount the label.





Flexschild / Flex Sign

Dimensione (LxH) (mm) Dimension (WxH) (mm)	Cod. Item-No.	+ Colore + Color	Documento / Cartoncino For Documents / Cardboard	Confezione Pack
67 x 300	FX-SK-67-	01 02 03 04 05 06 07 20	ET800	10 pezzi / pieces
110 x 300	FX-SK-	01 02 03 04 05 06 07 20	1/2 DIN A4	10 pezzi / pieces
210 x 300	FX-SK-A4-	01 02 03 04 05 06 07 20	DIN A4	10 pezzi / pieces

Cartoncini a pag. 110 / Cardboards page 110

Cartoncini (ET)
Cardboards (ET)



Cod. <i>Item-No.</i>	Dimensione (HxL) (mm) <i>Dimension (WxH) (mm)</i>	Cartoncini / Conf. <i>Cardboards / Pack</i>	Fogli pretagliati <i>Sheets</i>
ET75	75 x 27	200	10 pezzi / pieces
ET85	200 x 85	30	10 pezzi / pieces
ET100	100 x 27	200	10 pezzi / pieces
ET135	200 x 135	20	10 pezzi / pieces
ET150	150 x 27	100	10 pezzi / pieces
ET190	75 x 20	280	10 pezzi / pieces
ET200	100 x 25	220	10 pezzi / pieces
ET210	100 x 20	280	10 pezzi / pieces
ET220	150 x 20	140	10 pezzi / pieces
ET230	75 x 25	220	10 pezzi / pieces
ET250	150 x 25	110	10 pezzi / pieces
ET275	75 x 22	260	10 pezzi / pieces
ET300	100 x 38	140	10 pezzi / pieces
ET302	102 x 36	160	10 pezzi / pieces
ET335	100 x 35	160	10 pezzi / pieces
ET350	150 x 38	70	10 pezzi / pieces
ET375	75 x 38	140	10 pezzi / pieces
ET378	78 x 36	160	10 pezzi / pieces
ET400	100 x 47	120	10 pezzi / pieces
ET402	102 x 43	120	10 pezzi / pieces
ET450	150 x 47	60	10 pezzi / pieces
ET475	75 x 47	120	10 pezzi / pieces
ET500	100 x 50	100	10 pezzi / pieces
ET520	200 x 50	50	10 pezzi / pieces
ET550	150 x 50	50	10 pezzi / pieces
ET600	100 x 67	80	10 pezzi / pieces
ET650	150 x 67	40	10 pezzi / pieces
ET670	200 x 67	40	10 pezzi / pieces
ET700	300 x 50	40	10 pezzi / pieces
ET730	600 x 50	50	50 pezzi / pieces
ET800	300 x 67	60	20 pezzi / pieces
ET830	600 x 67	50	50 pezzi / pieces
ET76-70	76 x 70	80	10 pezzi / pieces
ET105-148	105 x 148	40	10 pezzi / pieces

ORGATEX®

Gli inserti di cartoncino sono il prerequisito fondamentale per un'etichettatura chiara di scaffali e contenitori. Possono anche essere usate come cartellini Kanban o Heijunka.

La microforatura che corre lungo il bordo permette di rimuovere gli inserti in cartoncino senza lasciare residui e senza bisogno di forbici o taglierini.

I fogli possono essere stampati su tutte le stampanti standard.

Ciò riduce notevolmente il lavoro di manipolazione durante la creazione e la progettazione degli inserti in cartoncino



Neat and easy-to-design cardboard inlays are the basic prerequisite for clear labeling of shelving and containers. They can also be used as Kanban or Heijunka cards.

The micro-perforation running around the edge allows the cardboard inserts to be removed without leaving any residue and without the need for scissors or cutter knives.

The sheets can be printed on all standard printers. This greatly minimizes the handling work for when creating and designing cardboard inserts.





Segnaletica orizzontale

Floor Markings

All'avanguardia:
con la nostra
segnaletica per
pavimenti LongLife sei
sempre sulla strada
giusta

Il programma segnaletica orizzontale LongLife è specifico per la delimitazione delle aree produttive e di stoccaggio. I formati e i colori disponibili permettono una implementazione veloce del Lean Visual Management per ridurre gli sprechi. La chiara marcatura sul pavimento aumenta la sicurezza sul lavoro e facilita il rispetto delle normative di sicurezza.

Poiché le marcature sul pavimento sono esposte a carichi speciali devono essere estremamente resistenti. Definiamo da anni lo standard nel campo della segnaletica orizzontale: i nostri prodotti LongLife, realizzati in PVC di alta qualità resistente alla torsione, si distinguono per la loro estrema resistenza. Sono a prova di carrello elevatore e tollerano persino i carichi più pesanti. Sono facili e veloci da applicare e, grazie al nostro LongLife Remover, possono anche essere rimossi senza lasciare residui. La nostra segnaletica orizzontale è disponibile in più versioni adatte ad ambienti produttivi differenti.

Whether driving and walking paths, danger zones or storage spaces - the correct marking is an absolute must. Clear floor markings increase occupational safety and make it easier to comply with regulations.

Since the markings on the floor have to endure special loads, they must be extremely durable. We had been setting the standard in the field of self-adhesive floor markings for years: our LongLife Floor Markings made of torsion-resistant, high-quality plastic are extremely resilient. They are „stacker-proof“ and even tolerate turning on the marking.

They are easy and quick to install and can also be removed free of residue thanks to our LongLife Remover. Our floor markings are used indoors and adhere to all surfaces such as concrete, stone and metal. They are available in a wide variety of designs: our floor markings are used as rolls to mark traffic routes, storage spaces, work and security areas.

La gamma di prodotti per l'identificazione a terra garantisce la sicurezza in azienda in conformità con gli standard. LongLife comprende anche vari simboli di delimitazione, schermi protettivi per contrassegnare gli spazi di stoccaggio e simboli di classificazione. Per aree con carichi molto pesanti abbiamo sviluppato la nostra serie LongLife Heavy Duty. I prodotti LongLife sono in continuo sviluppo per rispondere alle esigenze più estreme, come l'utilizzo in ambienti esterni o con basse temperature.

With our extensive range of identification labels, you ensure security in the company in accordance with standards. Our portfolio also includes various symbols for orientation or marking, as well as floor windows for marking storage spaces. And for areas with excessively extreme loads, we have developed our LongLife Heavy Duty series, which can be used, for example, to mark routes that are subject to extreme strain.

*Leading the way: with our
LongLife Floor Markings you
are always on the safe path*



LongLife segnaletica orizzontale
LongLife Floor Marking Tapes



LongLife simboli di classificazione
LongLife Floor Signs



LongLife MODUL
LongLife MODULE



LongLife simboli di delimitazione
LongLife Floor Symbols



eOX-Spot
eOX-Spot



LongLife Cold Performance
LongLife Cold Performance



LongLife schermi protettivi
LongLife Clearview



LongLife Heavy Duty
LongLife Heavy Duty

Segnaletica orizzontale

Infographic Floor Markings

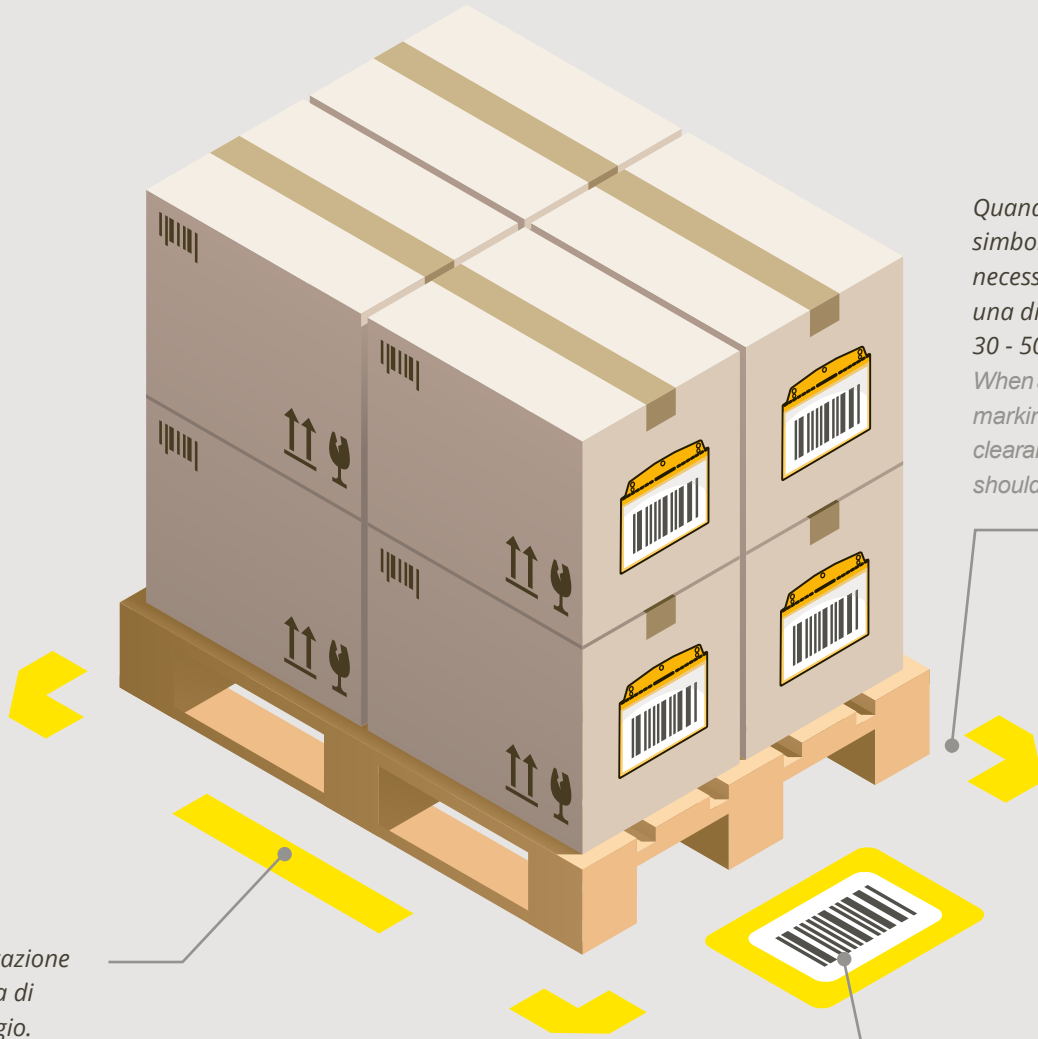

Quando si applicano i simboli di delimitazione è necessario mantenere una distanza minima di 30 - 50 mm dall'oggetto.
When applying the floor markings, a minimum clearance of 30 - 50 mm should be maintained.

Identificazione dell'area di stoccaggio.
Identification of storage areas.

Identificazione personalizzata del materiale con finestre in formato DIN.
Creation of your own floor signag in DIN format.



Facile installazione.
Adesivo e resistente alla torsione
*Easy and quick assembly.
Self-adhesive and torsion-resistant.*



Differente materiale e spessore per ogni necessità
Different materia thicknesses for every requirement



Codifica per colori delle differenti aree
Color coding of walkways and floor space

ORGATEX®



LongLife Cold Performance

Adesivo per la segnaletica di aree con temperature estremamente basse (efficiente fino a temperature di -20°C).

LongLife Cold Performance

Self-adhesive floor marking for areas with extremely low ambient temperatures (adhesive temperature down to -20°C).



Dimensioni e formati standard

Standard Format sizes

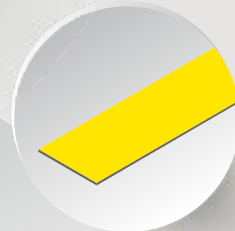

LongLife

È costituito da plastica di alta qualità resistente alla torsione e ha un'elevata resistenza all'abrasione. Può essere facilmente applicato direttamente dal cartone di imballaggio che funge da dispenser.

LongLife Marking Tapes

Consists of torsion-resistant, high-quality plastic and has a high abrasion resistance. Can be easily attached directly from the roll dispenser.

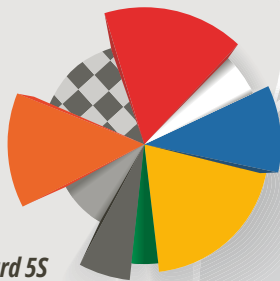

Colori standard 5S
Standard 5S colors



Resiste al passaggio di muletto

Forklift resistant

LongLife simboli di delimitazione

Garantisce la facile segnalazione di parcheggi e aree riservate. Il forte adesivo industriale sul retro è adatto a tutte le superfici come cemento, pietra, metallo, ecc. Diversi colori, larghezze e forme consentono una chiara classificazione / allocazione delle funzioni.

LongLife Symbols

Ensuring the easy marking of parking and restricted areas. The strong industrial adhesive on the back is suitable for all surfaces such as concrete, stone, metal etc. Different colors, widths and shapes enable a clear classification / allocation of the functional.

LongLife simboli di classificazione

Realizzato in PVC e completamente adesivo. Estremamente resistente all'usura. Rispettare le norme e i regolamenti secondo ASR A1.3.

LongLife Floor Marking Signs

Made of PVC and fully adhered. Extremely hard-wearing and wear-resistant. Comply with the norms and regulations according to ASR A1.3.

Altri simboli su richiesta.

We manufacture other symbols on request.



Opzioni segnaletica orizzontale

Design option Marking example

Suggerimenti sull'utilizzo del colore

Recommendation colour spectrum

	Zona principale <i>Main and Side Paths</i>		Prodotto finito / Area spedizione <i>Finished Material / Shipping Area</i>
	Materiale in lavorazione <i>Raw Material / Goods Receiving Area</i>		Materiale non conforme <i>Discharge / Defective Parts</i>
	Zona pericolosa <i>Hazardous Zones</i>		Zona contenitori vuoti <i>Empties</i>
	Zone varie (posizione carrelli, attrezzi, ecc.) <i>Additional Storage Areas</i>		



Segnale di obbligo: descrive un comportamento da tenere obbligatoriamente nelle aree contrassegnate. Le versioni progettate secondo lo standard ASR A1.3 evidenziano i pericoli non immediatamente riscontrabili e influenzano attivamente il comportamento dei dipendenti. La segnaletica di obbligo contribuisce ad un significativo aumento della sicurezza sul lavoro.

Mandatory Signs stipulate compulsory conduct in the marked areas. The version designed in accordance with the ASRA1.3 standard points out dangers that are not readily apparent, and actively influences the behavior of the employees. Mandatory signs contribute to a significantly increase in work safety.



Segnale di pericolo: è utilizzato ovunque pericoli quali carichi sospesi, carrelli elevatori industriali o rumore, colpiscono direttamente i dipendenti. Un'adeguata segnaletica garantisce il rispetto delle normative di sicurezza.

Warning and information signs are used wherever hazards such as suspended loads, industrial forklifts or noise, directly affect employees. Appropriate signage ensures you comply with legal requirements.



Segnale di divieto: ha il maggior peso nel gruppo dei simboli di classificazione. I segnali di questa categoria vietano determinati tipi di comportamenti vietati per evitare incidenti con gravi conseguenze.

Prohibition signs have the greatest weighting in the group of safety signs. Signs in this category prohibit certain types of behavior and clearly communicate prohibited conduct to avoid accidents with serious consequences.

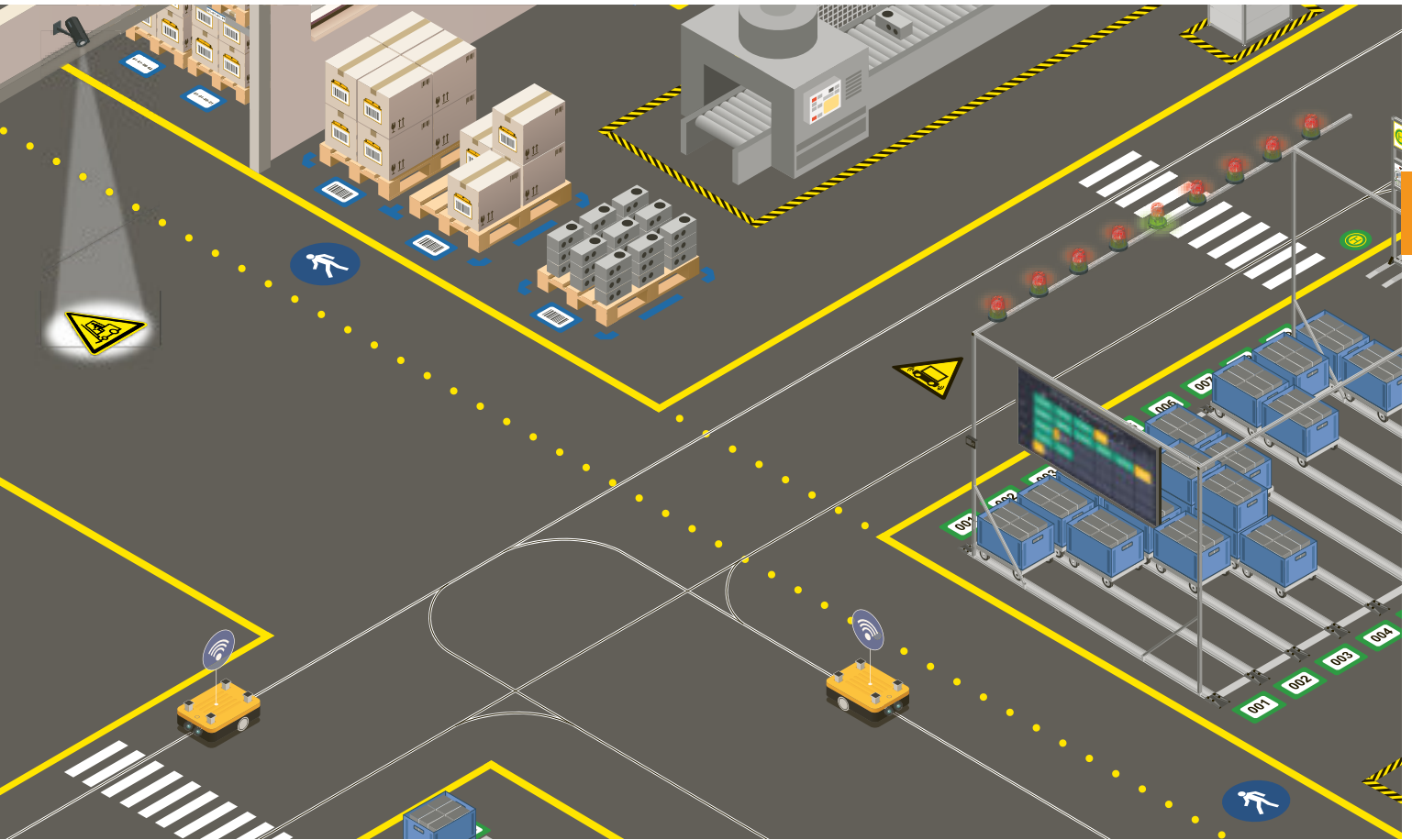

Segnaletica orizzontale: serve a separare chiaramente diverse aree, ad es. vie di traffico e passaggi pedonali o aree di stoccaggio e produzione. Oltre all'aspetto della sicurezza, le aree chiaramente contrassegnate contribuiscono anche ad aumentare l'efficienza e ad evitare errori causati dalla confusione tra materiali di tipo diverso. Tale scopo, contrassegni in diversi colori, monocromatici o multicolori, ad es. vengono utilizzati e assegnati ad applicazioni differenti.



Simboli: sono lo strumento ottimale per una chiara visualizzazione delle aree diverse nelle quali è possibile delimitare di postazioni pallet, aree di entrata / uscita merci, vuoti e aree di approvvigionamento, logistiche o di produzione. Ottimale l'utilizzo di dimensioni e colori diversi.

Longitudinal markings serve to clearly separate different areas, e.g. traffic routes and walkways or storage and production areas. In addition to the safety aspect, clearly marked areas also contribute to increased efficiency and avoidance of errors caused by confusion with materials and raw materials. For this purpose, markings in different colors, single or multi-colored, e.g. hatched, are used and assigned to an application.

Symbols are the optimal tool for clear visualization of different areas. Different dimensions and a wide variety of colors can be used for marking logistics and production areas. This enables individual areas such as goods receipt / goods outward, empties, blocking areas or material provision areas to be clearly assigned a specific application.

Lavorare con la segnaletica orizzontale

Floor Marking Processing

Una chiara assegnazione dei materiali ai processi di produzione e logistici è indispensabile per garantire qualità ed efficacia. Se l'identificazione di prodotti semilavorati o finiti non può essere completamente ottenuta solo con sfruttando i colori della segnaletica orizzontale, può essere completata attraverso il contributo di schermi protettivi che permettono l'esposizione di codici a barre o altri codici alfanumerici. La speciale superficie degli schermi rifrange la luce artificiale per consentire la scansione, ad esempio, di codici QR o codici a barre senza errori. La superficie garantisce un effetto antiscivolo.

A clear assignment of materials to production or logistics processes is unavoidable for reasons of quality assurance and effectiveness.

If labeling of, for example, semi-finished or finished products cannot be fully achieved solely by the floor marking color, this is 100% achieved through floor signs. Here barcodes, item numbers or printed images can be used as additional information in combination with LongLife clearview. The special surface structure of the floor signs refracts the light of ceiling lighting to enable the scanning of, for example, QR codes or barcodes without errors, and also has an anti-slip effect.



Le stampe in formato DIN su carta normale, per contrassegnare le aree di stoccaggio in combinazione con schermi protettivi creano una segnaletica a pavimenti ottimamente protetta.

Print labels e.g. for marking storage areas in standard DIN format on normal paper, and, in conjunction with the LongLife clearview, excellently protected floor signage is created.



Creazione rapida della propria segnaletica da pavimento: la stampa su carta standard viene posizionata dietro lo schermo che impedisce i riflessi mantenendo così la leggibilità dello scanner. Il bordo adesivo protegge la stampa da influenze esterne come polvere o umidità e forma un solido legame con il supporto.

Rapid creation of your own floor signage. The printout on standard paper is placed behind the specially structured strip, which prevents reflections, e.g. from ceiling lights, thus maintaining scanner readability. All round adhesive strips protect the print from external influences such as dust or moisture and form a solid bond with the substrate by simply pressing onto it.





ORGATEX®



Pulizia dei pavimenti con
LG-CLEANER per rimozioni di oli,
grassi e polvere
*Clean surface with LG-CLEANER,
remove dirt, grease and oil*



Temperatura ideale di
utilizzo compresa tra
18° C e 25° C
*Ideal processing
temperature 18C° - 25C°*



Posa: attendere 12 ore
dalla pulizia
Leave 12 hours to set



Non sovrapporre il LongLife
Do not overlap floor markings



La forza di adesione a pavimento dipende dalle condizioni dello stesso. Su pavimento a piastrelle si consiglia l'utilizzo di LongLife - Simboli per delimitazione in quanto le fughe riducono la forza adesiva del LongLife - Segnaletica orizzontale.

The strength of adhesion to the floor depends on the conditions of the same. On tiled floors we recommend the use of LongLife - Symbols for delimitation as joints reduce the adhesive strength of LongLife - Horizontal signs.

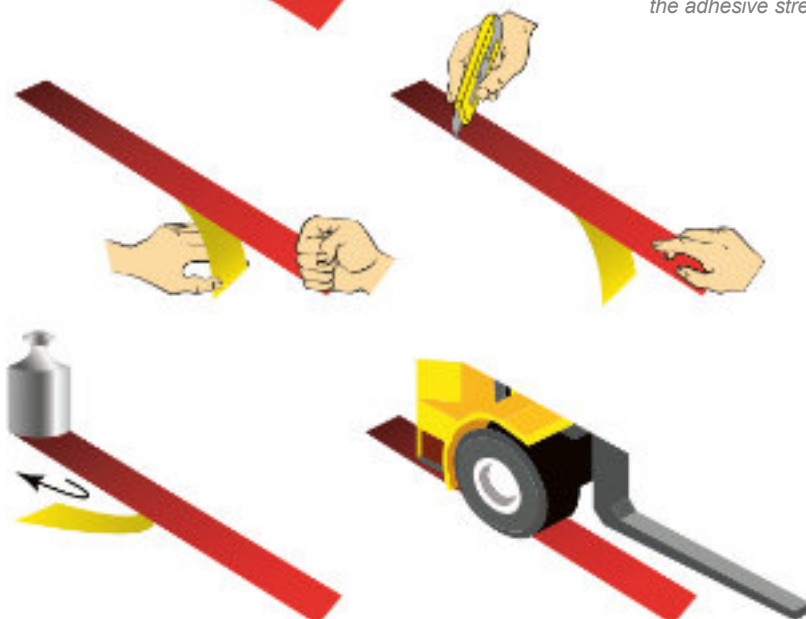

LongLife Remover / LongLife Cleaner / LongLife Primer

LongLife Remover / LongLife Cleaner / LongLife Primer

LongLife Remover: prodotto indicato per rimuovere eventuali residui di collante e preparare in maniera ottimale il pavimento per l'eventuale nuova applicazione. Esente da solventi.

LongLife Cleaner: prodotto indicato per la pulizia del pavimento prima dell'applicazione della segnaletica orizzontale. Bisogna accertarsi che la superficie sia priva di polvere e di olio per garantire la massima adesione.

LongLife Primer: prodotto utilizzabile con tutti gli articoli della linea LongLife per aumentare l'efficacia adesiva nelle zone ad alta sollecitazione. L'utilizzo di LongLife Primer è invece obbligatorio nell'applicazione del LongLife Outdoor.

LongLife Remover: if any adhesive remains on the surface after the old floor markings have been removed, we highly recommend LongLife Remover to clear the residues.

LongLife Cleaner: please make sure that the floor is free from dirt and oil before floor markings are applied. We recommend our LongLife Cleaner for pre-cleaning of floors.

LongLife Primer: product that can be used with all items in The LongLife line to increase the adhesive effectiveness in highly trafficked areas. The use of LongLife Primer is instead mandatory in the application of LongLife Outdoor.





LongLife Remover / LongLife Cleaner / LongLife Primer

Prodotto <i>Designation</i>	Cod. <i>Item-No.</i>	Unità / Confezione <i>Units / Pack</i>
LongLife Remover	LG-REMOVER/6	6 x 1 Litro / <i>Liter</i>
LongLife Cleaner	LG-CLEANER/6	6 x 1 Litro / <i>Liter</i>
LongLife Primer	LG-PRIMER	1 x 1 Litro / <i>Liter</i>

LongLife segnaletica orizzontale

LongLife Floor Marking Tape Product range

È un nuovo sistema per la segnaletica orizzontale.

La speciale plastica utilizzata e il potente adesivo rendono il prodotto resistente ai passaggi dei muletti ed ai lavaggi.

Nuovi prodotti, nuova varietà. La nostra gamma è stata notevolmente ampliata. I prodotti LongLife recentemente aggiunti includono: Low Duty (LD), Outdoor (OD), GRIP e Heavy Duty (HD). Inoltre, siamo lieti di personalizzare il nostro nastro per la marcatura dei pavimenti in base alle vostre richieste. Questo ti garantisce di avere sempre la soluzione perfetta per il tuo caso specifico.

Find the right floor marking tape for your individual case.

Always the right marking - no matter the ground conditions or the purpose! With our tapes from LongLife, you adhere precisely as well as with long-term stability against abrasion: e.g., parking spaces, main or side walkways or security areas.

New products, new variety. Our range has been greatly expanded. Recently added LongLife products include: Low Duty (LD), FTS, GRIP and Heavy Duty (HD). Besides, we are happy to custom make our floor marking tape according to your requests. This guarantees that you always have the perfect solution for your specific case.

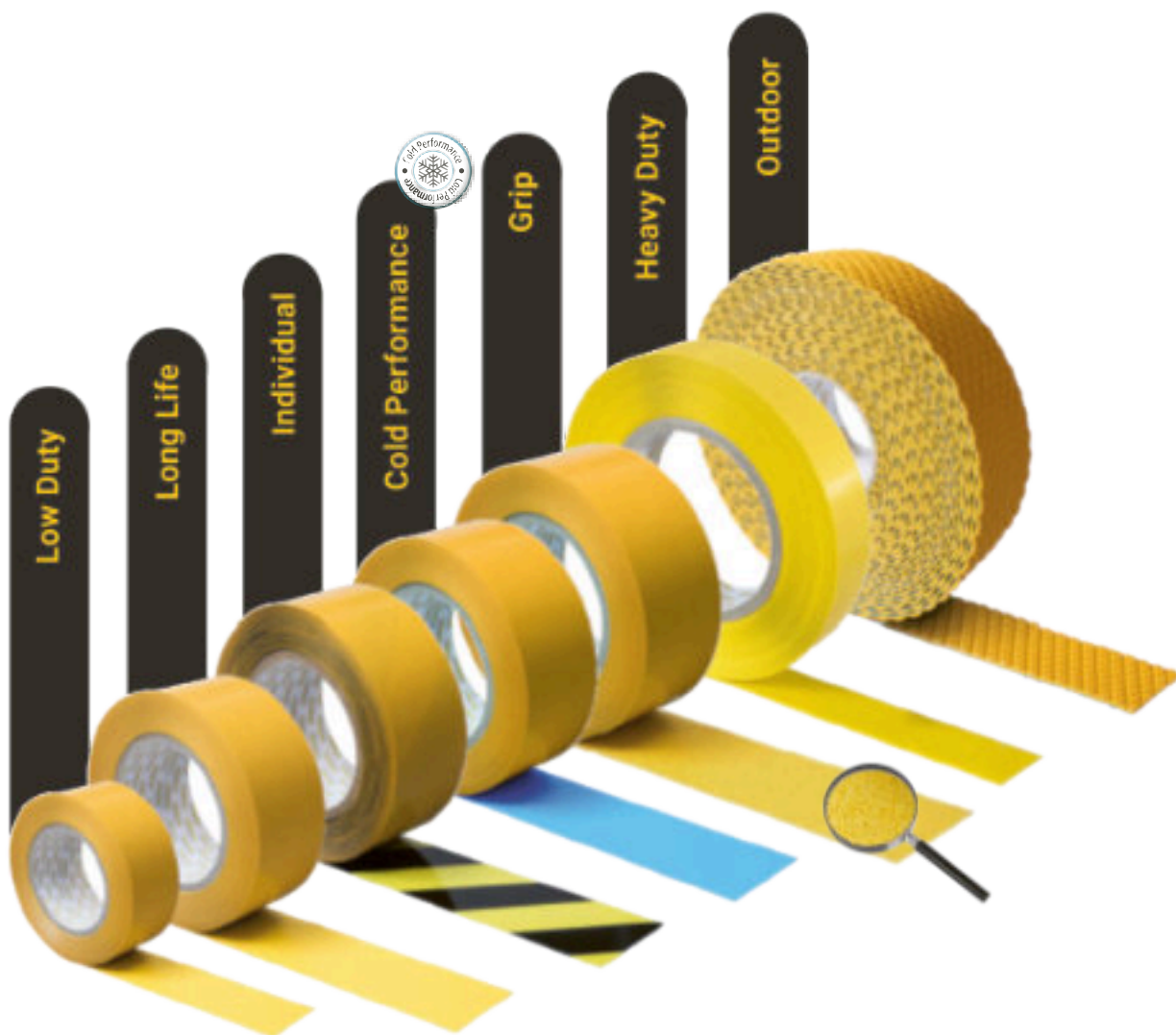

LongLife - Segnaletica orizzontale / Overview LongLife Floor Marking Tape							
	Low Duty <i>Low Duty</i>	LongLife <i>LongLife</i>	Cold Performance <i>Cold Performance</i>	LongLife Bicolore <i>Individual</i>	Grip <i>Grip</i>	Heavy Duty <i>Heavy Duty</i>	Outdoor <i>Outdoor</i>
Calpestabile da pedoni <i>Pedestrian traffic</i>	✓	✓	✓	✓	✓	✓	✓
Resistente passaggio transpallet <i>Liftruck traffic</i>	✓	✓	✓	✓	✓	✓	✓
Resistente passaggio muletti <i>Forklift traffic</i>	-	✓	✓	✓	✓	✓	✓
Resistente passaggio muletti pesanti <i>Heavy forklift traffic</i>	-	-	-	-	-	✓	-
Materiale <i>Material</i>	PVC Morbido <i>Soft PVC</i>	Film PVC <i>PVC film</i>	Film PVC <i>PVC film</i>	Film PVC <i>PVC film</i>	Poliuretano <i>Polyurethane</i>	Film PVC <i>PVC film</i>	Poliuretano <i>Polyurethane</i>
Spessore (mm) <i>Thickness (mm)</i>	0,16	0,48	0,48	0,48	1,6 ± 0,1	1,3	2,8 ± 0,5
Superficie <i>Surface</i>	Opaca <i>Matt</i>	Leggermente lucida <i>Light glossy</i>	Leggermente lucida <i>Light glossy</i>	Opaca <i>Matt</i>	Retroriflettente <i>Retroreflective</i>	Leggermente lucida <i>Light glossy</i>	Opaca riflettente <i>Matt reflective</i>
Livello antiscivolo <i>Slip class</i>	-	-	-	-	R12 (DIN EN 16165)	-	Antiscivolo <i>Slip resistance</i>
Colla <i>Glue</i>	Gomma <i>Rubber</i>	Acrilato modificato <i>modified acrylate</i>	Acrilato <i>Acrylate</i>	Acrilato <i>Acrylate</i>	Gomma sintetica <i>Synthetic rubber</i>	Acrilato modificato <i>Modified acrylate</i>	Gomma sintetica <i>Synthetic rubber</i>
Forza adesiva <i>Adhesive strength</i>	1,5 N/cm	13,6 N/cm	10,8 N/cm	13,6 N/cm	27,4 N/cm	21,2 N/cm	27 N/cm
Range temperatura <i>Temperature range</i>	-20°C / +120°C	-20°C / +70°C	-40°C / +60°C	-20°C / +70°C	-20°C / +70°C	-20°C / +70°C	-20°C / +70°C
Temperatura ideale <i>Working temperature</i>	≥ 12°C	+18°C / +25°C	fino a -10°C	+18°C / +25°C	≥ 20°C	+18°C / +25°C	≥ 12°C
Lunghezza (m) <i>Available lengths (m)</i>	33	50	50	50	25	25	12,5
Larghezza (mm) <i>Available widths (mm)</i>	50 / 75	50 / 75 / 100	50 / 75 / 100	50 / 75	50 / 75 / 100	50	50 / 75 / 100



LongLife Low Duty

LongLife Floor Marking Tape Low Duty

LongLife Low Duty è uno strumento fondamentale nella Segnaletica orizzontale destinato all'uso temporaneo. Un altro possibile ambito di applicazione è la marcatura temporanea delle aree pilota.

- Adatto per pavimenti lisci
- Per uso interno ed esterno
- Resistente all'abrasione, all'usura e all'umidità
- Texture solida
- Si adatta alle superfici
- Migliora la sicurezza

Mark your employees' way: using our LongLife LD PVC tape. It is designed specifically for temporary use and is perfect for areas with low impact on the ground. Convincing due to its firm texture, the marking tape is resistant to normal abrasion. It also conforms to a wide variety of materials and surfaces - including concrete screeds, MMA coatings and tiles. This allows you to create clear structures for more safety.

- Suitable for plain floors
- For indoor and outdoor use
- Resistant to abrasion, decomposition and moisture
- Firm texture
- Adapts to surfaces
- Provides security





LongLife Low Duty / LongLife Floor Marking Tape Low Duty

	Dimensione (L) (mm) Format (W) (mm)	Cod. Item-No.	+ Colore + Color	Rotolo Rolls
LongLife Low Duty	50	LGLD50-	01 02 04 05 06 08 10 - -	3 x 33 metri / meters
LongLife Low Duty	50	LGLD50-	- - - - - - - SG RW	3 x 33 metri / meters
LongLife Low Duty	75	LGLD75-	01 02 04 05 06 08 10 - -	2 x 33 metri / meters
LongLife Low Duty	75	LGLD75-	- - - - - - - SG RW	2 x 33 metri / meters

LongLife

LongLife Floor Marking Tape

È un nuovo sistema per la segnaletica orizzontale. La speciale plastica utilizzata e il potente adesivo rendono il prodotto resistente ai passaggi dei muletti ed ai lavaggi.

- Facile da applicare
- Resistente al passaggio dei carrelli elevatori
- Alta resistenza alle abrasioni
- Potente adesivo
- Materiale antigraffio
- Munito di dispenser in cartone

A product made of high-quality plastic combined with a high-performance adhesive.

- Easy to install
- Forklift resistant
- High abrasion resistance
- Outstanding adhesive strength
- Scratch-proof material
- Format: roll in self-dispensing carton

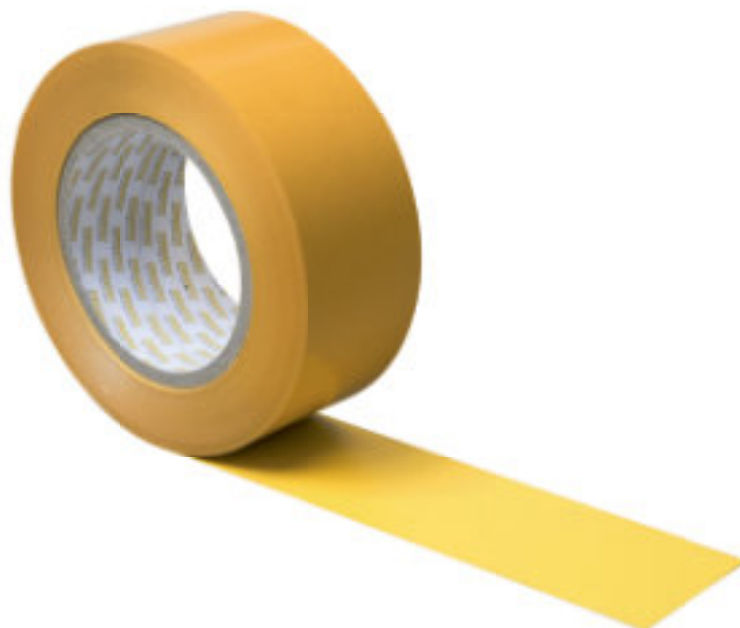



LongLife / Angoli 45° e 90° / LongLife Floor Marking Tape / Angles 45° and 90°

	Dimensione (Larghezza) (mm) Dimension (Width) (mm)	Cod. Item-No.	+ Colore + Color	Rotolo / Confezione Roll / Pack
LongLife / Floor Marking Tape	50	LG50-	01 02 03 04 05 06 07 08 10	50 metri / meters
LongLife / Floor Marking Tape	75	LG75-	01 02 03 04 05 06 07 08 10	50 metri / meters
LongLife / Floor Marking Tape	100	LG100-	01 02 03 04 05 06 07 08 10	50 metri / meters
Angolo a 45° / 45° Angle	50	LG-50-W45-	01 02 03 04 05 06 07 08 10	50 pezzi / pieces
Angolo a 45° / 45° Angle	75	LG-75-W45-	01 02 03 04 05 06 07 08 10	50 pezzi / pieces
Angolo a 45° / 45° Angle	100	LG-100-W45-	01 02 03 04 05 06 07 08 10	50 pezzi / pieces
Angolo a 90° / 90° Angle	50	LG-50-W90-	01 02 03 04 05 06 07 08 10	50 pezzi / pieces
Angolo a 90° / 90° Angle	75	LG-75-W90-	01 02 03 04 05 06 07 08 10	50 pezzi / pieces
Angolo a 90° / 90° Angle	100	LG-100-W90-	01 02 03 04 05 06 07 08 10	50 pezzi / pieces

LongLife Individual

LongLife Floor Marking Tape individual

Nastro segnaletico personalizzabile o bicolore retrostampato con la nostra affidabile qualità LongLife.

- Facile da applicare
- Resistente al passaggio dei carrelli elevatori
- Alta resistenza alle abrasioni
- Potente adesivo
- Materiale antigraffio
- Munito di dispenser in cartone

Two-color back-printed floor marking tape with our reliable LongLife quality.

- Easy to install
- Forklift resistant
- High abrasion resistance
- Outstanding adhesive strength
- Scratch-proof material
- Equipped with cardboard dispenser

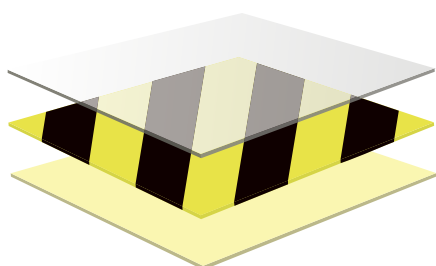
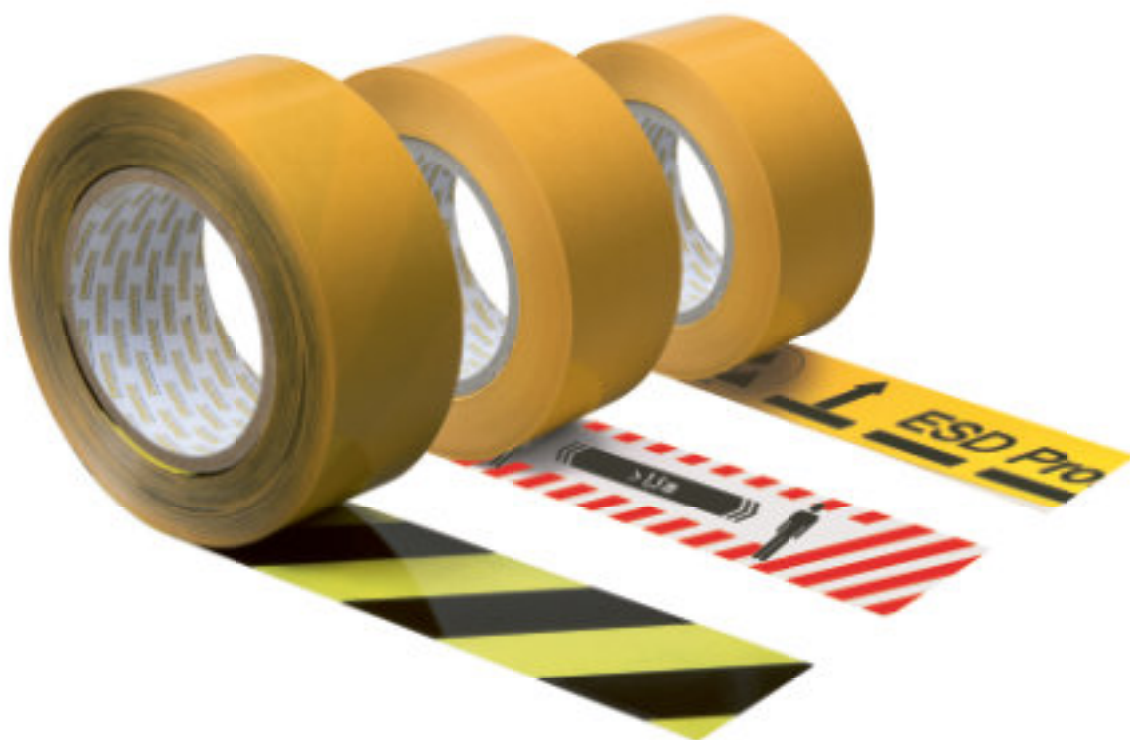



LongLife Bicolore / LongLife Floor Marking Tape individual

	Dimensione (L) (mm) Format (W) (mm)	Cod. Item-No.	+ Colore + Color ■ ■ ■ ■ ■	Rotolo Roll
Nastro bicolore / Tape hatched	50	LG50-	SG BW GW RW SW	50 metri / meters
Nastro bicolore / Tape hatched	75	LG75-	SG BW GW RW SW	50 metri / meters
Nastro distanziamento / Tape Keep distance	50	LG50-SD	- - - - -	50 metri / meters
Nastro delimitazione e area ESD / Tape ESD Protected Area	50	LG50-ESD	- - - - -	50 metri / meters
	Dimensione (LxL) (mm) Dimension (WxL) (mm)	Cod. Item-No.		Confezione Pack
Elemento distanziamento / Marking keep distance	75 x 350	LG-75350-SD		10 pezzi / pieces
Elemento distanziamento / Marking keep distance	100 x 500	LG-100500-SD		10 pezzi / pieces
Fornibile a richiesta con grafica personalizzata			Available on request with customized graphics	

LongLife Grip

LongLife Floor Marking Tape Grip

Utilizzando il LongLife GRIP con effetto antiscivolo è possibile creare facilmente delimitazioni del pavimento resistenti all'usura in modo da risparmiare tempi di manutenzione. La superficie antiscivolo e retro-riflettente è adatta per uso interno e aderisce facilmente a superfici come cemento, piastrelle e asfalto.

- Adatto a superfici lisci
- Per uso interno
- Adesivo resistente a lunga durata
- Antiscivolo e retro riflettente
- Facile da applicare
- Resistente alle abrasioni
- Applicabili su diversi tipi di superficie
- Immediatamente calpestabile

Spare yourself the hassle of marking grounds with real paint. Using the LongLife GRIP with anti-slip effect, you can easily create hard-wearing ground markings in a time-saving manner. The anti-slip and retroreflective surface is suitable for indoor use and adheres easily. In addition, the extra strong ground marking tape sticks to surfaces such as concrete, tiles and asphalt. Due to the permanent adhesion, it is also possible to drive on it. Start to mark smart now.

- Suitable for smooth and textured floors
- For indoor use
- Durable and self-adhesive
- Anti-slip and retroreflective
- Easy adhesion
- No abrasion
- Suitable for various surfaces
- Instantly walkable

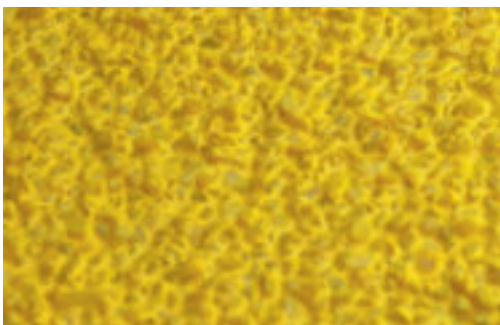



LongLife Grip / LongLife Floor Marking Tape Grip

	Dimensione (L) (mm) Dimension (W) (mm)	Cod. Item-No.	+ Colore + Color	Rotolo Roll
LongLife Grip	50	LGGRIP50-	01 02 04 05 06 10 SG	25 metri / meters
LongLife Grip	75	LGGRIP75-	01 02 04 05 06 10 SG	25 metri / meters
LongLife Grip	100	LGGRIP100-	01 02 04 05 06 10 SG	25 metri / meters

LongLife Heavy Duty

LongLife Floor Marking Tape Heavy Duty

Dura a lungo, anche su superfici molto trafficate: LongLife HD è il nostro nastro segnaletico a terra con un'elevata forza adesiva che resiste anche a carichi molto pesanti. Per le aree con elevato traffico di muletti e transpallet LongLife HD è il prodotto giusto per te. Il bordo fresato del nastro assicura che il passaggio di carrelli elevatori e muletti con carichi trasversali siano assorbiti molto bene.

- Altissima durata anche su superfici molto trafficate
- Alta adesività e resistenza alle abrasioni
- Bordi smussati per resistere alle sollecitazioni trasversali

Lasts for a long time, even on heavily frequented surfaces: LongLife HD is our ground marking tape with a high adhesive strength that withstands even very heavy loads. Do you want to apply markings where carriers or industrial trucks with heavy weights run over the covered surfaces with high frequency? LongLife HD is the right product for you. The milled edge of the belt ensures that even cross-directional loads, e.g., from forklifts driving over, are absorbed particularly well.

- Lasts long on heavily used surfaces
- High adhesion, little abrasion
- Milled edge against cross forces





LongLife Heavy Duty / LongLife Floor Marking Tape Heavy Duty

	Dimensione (L) (mm) Dimension (W) (mm)	Cod. Item-No.	+ Colore + Color	Rotolo Roll
LongLife HD	50	LGHD-50-	01 02 04 05 10	25 metri / meters

LongLife Cold Performance

LongLife Floor Marking Cold Performance

La nuova marcatura da pavimento Longlife Cold Performance è adatta per tracciare percorsi di guida, parcheggi, punti pericolosi o vie di fuga. È stato sviluppato appositamente per ambienti industriali con temperature ambiente estremamente basse. Sono facili e veloci da applicare e possono essere utilizzati in breve tempo. Sono adatti a tutti i supporti, solo per uso interno. Prodotti in PVC di alta qualità con uno speciale adesivo a base di acrilato altamente resistente alle abrasioni, ai passaggi dei muletti ed ai lavaggi, sono di pratico utilizzo in quanto vengono forniti in rotolo da 50 metri in distributore di cartone e non richiedono tracciatore per la posa.

The new Longlife Cold Performance floor marking is suitable for tracing driving paths, parking lots, dangerous points or escape routes. It has been specially developed for industrial environments with extremely low ambient temperatures. They are easy and quick to apply and can be used only in a short time. They are suitable for all substrates, for internal use only. High quality PVC products with a special adhesive based on acrylate highly resistant to abrasions, forklifts and washes, are of practical use as they are supplied in rolls of 50 meters in a cardboard dispenser and do not require wire tracing for laying.

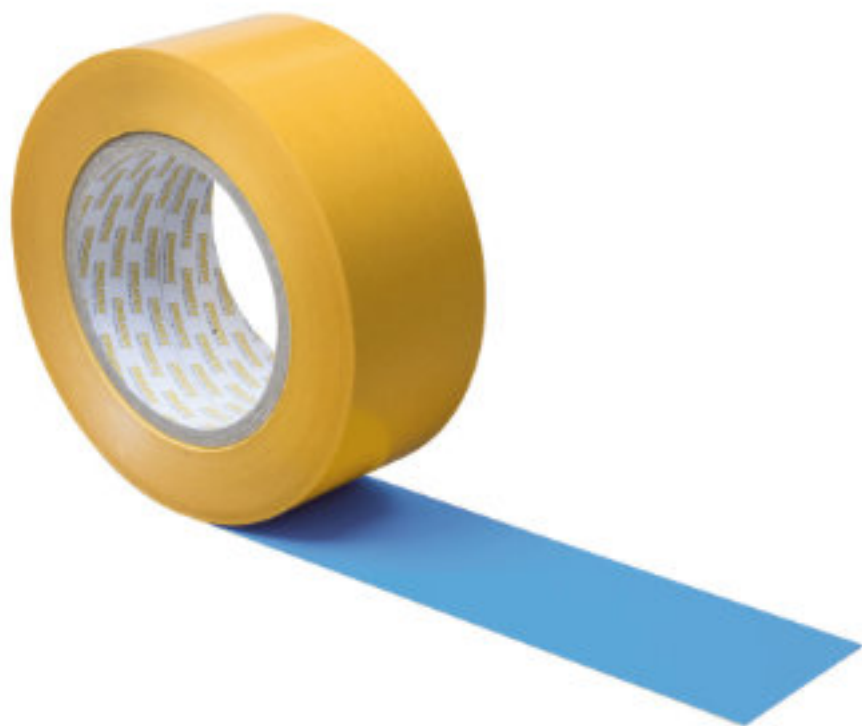



LongLife Cold Performance / LongLife Floor Marking Tape Cold Performance

	Dimensione (L) (mm) Dimension (W) (mm)	Cod. Item-No.	+ Colore + Color	Rotolo Roll
LongLife CP	50	LGCP50-	01 02 03 04 05 06 07 08 10	50 metri / meters
LongLife CP	75	LGCP75-	01 02 03 04 05 06 07 08 10	50 metri / meters
LongLife CP	100	LGCP100-	01 02 03 04 05 06 07 08 10	50 metri / meters

LongLife Outdoor

LongLife Floor Marking Tape Outdoor

LongLife Outdoor è un nastro per uso esterno. L'elevata resistenza del materiale e il forte adesivo in gomma sintetica garantiscono una lunga durata in condizioni difficili. La superficie tattile è anche antiscivolo quando è bagnata. Grazie alla natura dell'adesivo, il nastro può essere utilizzato sia su superfici ruvide che irregolari. Il prodotto viene utilizzato per contrassegnare vialetti e marciapiedi, ad esempio in aree di carico o magazzini esterni, nonché per contrassegnare possibili punti di pericolo sulle rampe di carico, come il bordo della rampa. È possibile anche l'uso in interno su superfici irregolari. 12,5 metri per rotolo.

LongLife Outdoor is a tape for outdoor use. The high strength of the material and the strong synthetic rubber adhesive ensure a long service life in tough conditions. The touch surface is also non-slip when wet. Due to the nature of the adhesive, the tape can be used on both rough and uneven surfaces. The product is used to mark driveways and sidewalks, for example in loading areas or external warehouses, as well as to mark possible danger points on loading ramps, such as the edge of the ramp. Indoor use on uneven surfaces is also possible. 12.5 m per roll.





LongLife Outdoor / LongLife Floor Marking Tape Outdoor

	Dimensione (Larghezza) (mm) Dimension (Width) (mm)	Cod. Item-No.	+ Colore + Color	Rotolo Roll
LongLife Outdoor	50	LGOD50-	02 04	12,5 metri / meters
LongLife Outdoor	75	LGOD75-	02 04	12,5 metri / meters
LongLife Outdoor	100	LGOD100-	02 04	12,5 metri / meters

Maschera di taglio LongLife

LongLife Trimming System

Sistema per tagliare con facilità e in modo personalizzato il LongLife. Il taglio avviene posizionando all'interno della lamiera piegata il LongLife che non scivola grazie ad un ottimo effetto bloccaggio.

- Acciaio inox
- Per taglio angoli a 45° e 90°
- Per LongLife da 50 / 75 / 100 mm

Useful tool for easily and safely cutting floor markings to size. The cut is made in the folded stainless steel sheet; no slipping due to good clamping properties.

- Angle 90° and Angle 45° on both sides
- Stainless-steel version
- Suitable for all widths 50 / 75 / 100 mm

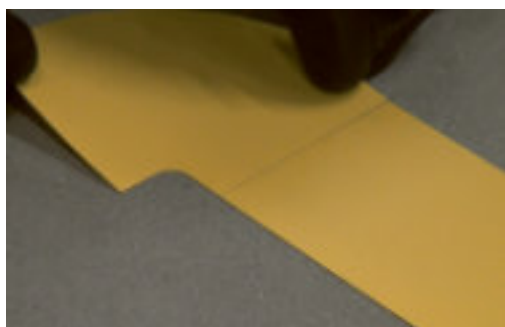
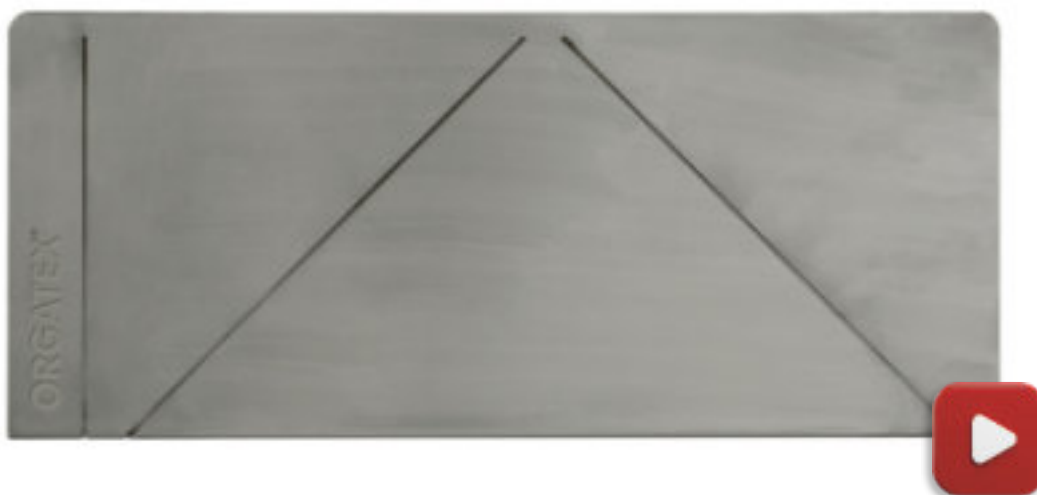

ORGATEX®

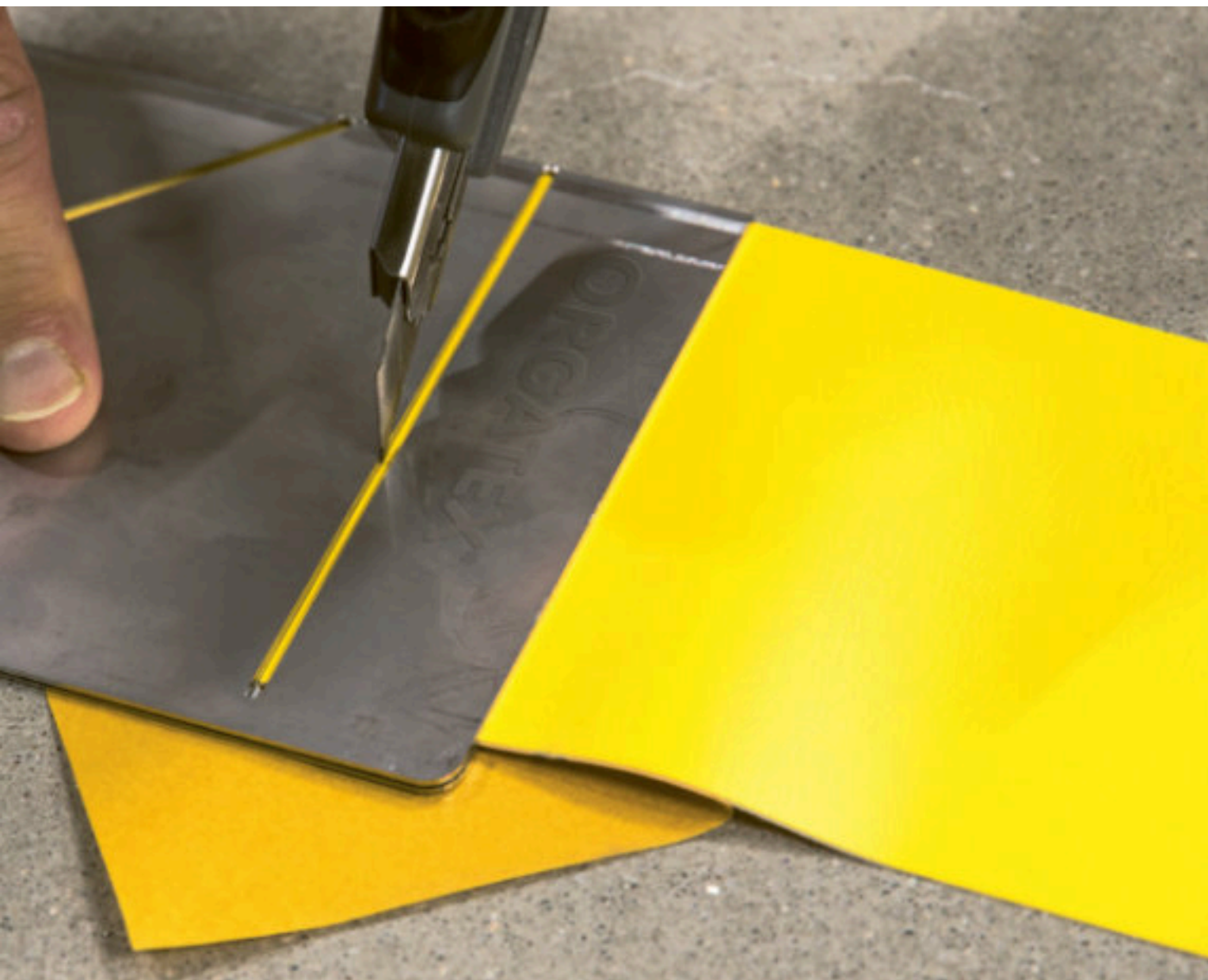

Maschera di taglio LongLife / LongLife Trimming System

Dimensione (HxL) (mm)
Dimension (WxL) (mm)

Cod.
Item-No.

120 x 250

LG-TS100

LongLife simboli per delimitazione

LongLife Symbols

Ideali per delimitare i passaggi e le zone di stoccaggio maggiormente esposti a usura. L'alta qualità del materiale e le estremità arrotondate rendono il prodotto resistente e funzionale.

- Elemento dritto
- Elemento a T
- Elemento a L
- Elemento quadrato

Available in 9 standard colors and in different widths for marking storage areas, storage spaces, transport routes, etc. Depending on the application area, we recommend the use of:

- Longitudinal marking
- T-Piece
- L-Angle
- Square

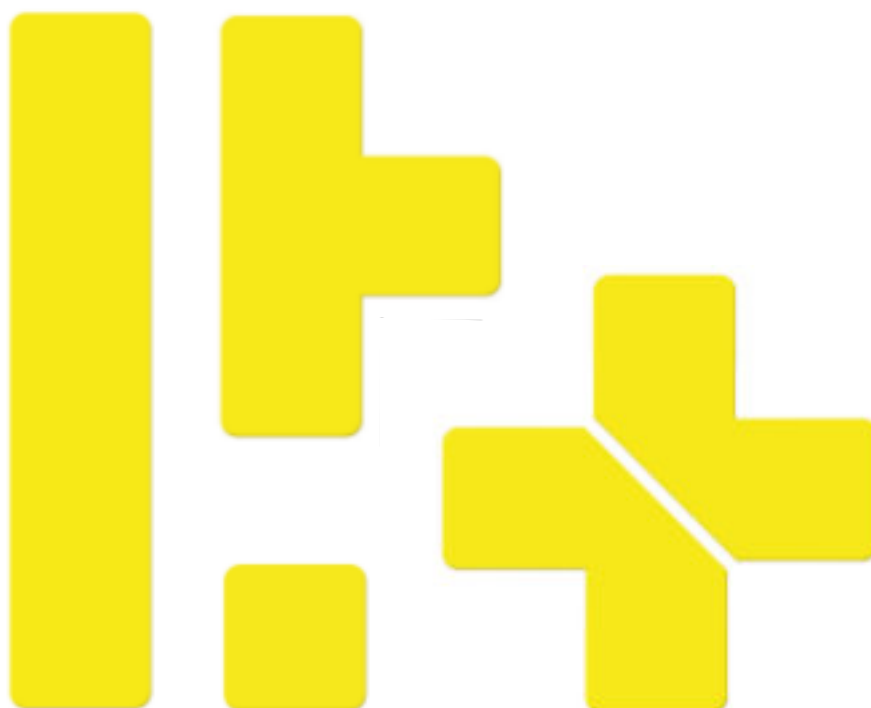



LongLife simboli di delimitazione / LongLife Symbols

	Dimensione (HxL) (mm) Dimension (WxL) (mm)	Cod. Item-No.	+ Colore + Color	Confezione Pack
Elemento a T / T-Piece	50	LG-50-T-	01 02 03 04 05 06 07 08 10	50 pezzi / pieces
Elemento a T / T-Piece	75	LG-75-T-	01 02 03 04 05 06 07 08 10	50 pezzi / pieces
Elemento a L / L-Angle	50	LG-50-L-	01 02 03 04 05 06 07 08 10	50 pezzi / pieces
Elemento a L / L-Angle	75	LG-75-L-	01 02 03 04 05 06 07 08 10	50 pezzi / pieces
Elemento diritto / Longitudinal marking	50 x 250	LG-50250-	01 02 03 04 05 06 07 08 10	50 pezzi / pieces
Elemento diritto / Longitudinal marking	75 x 350	LG-75350-	01 02 03 04 05 06 07 08 10	50 pezzi / pieces
Elemento diritto / Longitudinal marking	100 x 500	LG-100500-	01 02 03 04 05 06 07 08 10	50 pezzi / pieces
Elemento quadrato / Square	50	LG-50-Q-	01 02 03 04 05 06 07 08 10	50 pezzi / pieces
Elemento quadrato / Square	75	LG-75-Q-	01 02 03 04 05 06 07 08 10	50 pezzi / pieces
Elemento quadrato / Square	100	LG-100-Q-	01 02 03 04 05 06 07 08 10	50 pezzi / pieces

LongLife simboli per delimitazione rounded

LongLife Symbols Rounded

Ideali per delimitare i passaggi e le zone di stoccaggio maggiormente esposti a usura. L'alta qualità del materiale e le estremità arrotondate rendono il prodotto resistente e funzionale.

- Elemento diritto
- Elemento a T
- Elemento a L
- Elemento rotondo
- Elemento a croce (composto da 2 pezzi)

Available in 9 standard colors and in different widths for marking storage areas, storage spaces, transport routes, etc. Depending on the application area, we recommend the use of:

- Longitudinal marking
- T-Piece
- L-Angle
- Point
- Cross

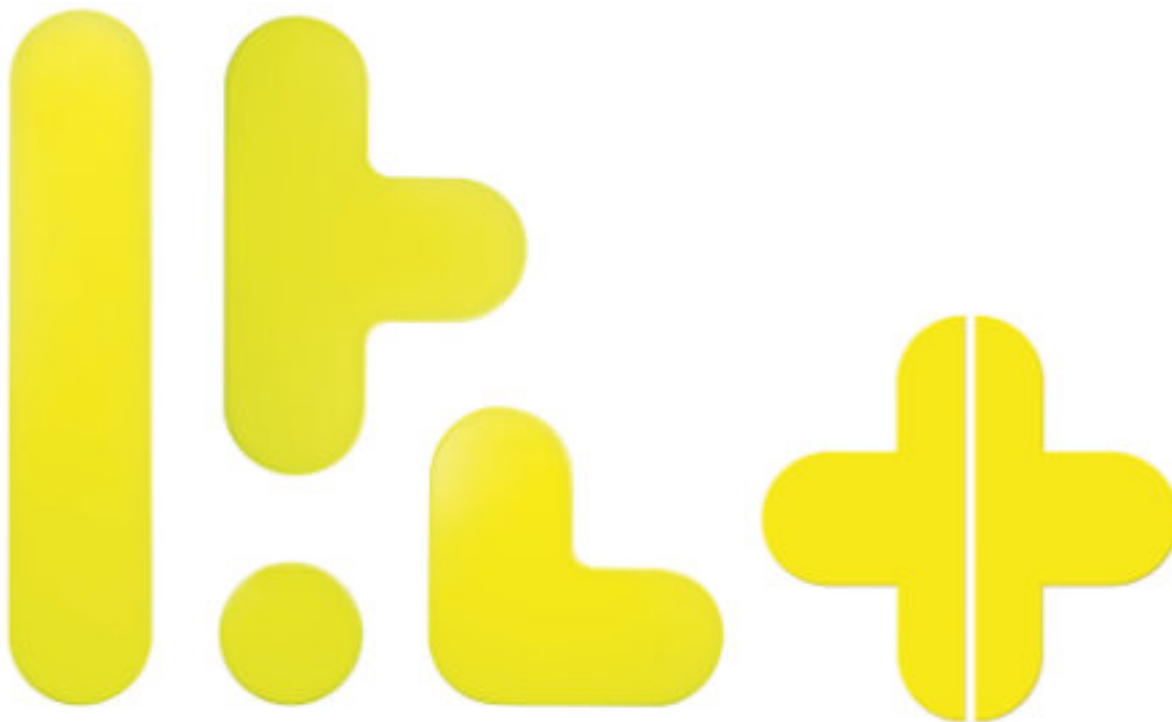



LongLife simboli per delimitazione Rounded / LongLife Symbole Rounded

	Dimensione (HxL) (mm) Dimension (WxL) (mm)	Cod. Item-No.	+ Colore + Color	Confezione Pack
Elemento a T / T-Piece	90	LGR-90-T-	01 02 03 04 05 06 07 08 10	50 pezzi / pieces
Elemento a L / L-Angle	90	LGR-90-L-	01 02 03 04 05 06 07 08 10	50 pezzi / pieces
Elemento diritto / Longitudinal marking	90 x 450	LGR-90450-	01 02 03 04 05 06 07 08 10	50 pezzi / pieces
Elemento rotondo / Point	90	LGR-90-P-	01 02 03 04 05 06 07 08 10	50 pezzi / pieces
Elemento a croce (composto da 2 Pz.) / Cross (2 pieces)	90	LGR-90-K-	01 02 03 04 05 06 07 08 10	50 pezzi / pieces

LongLife simboli piede e freccia

LongLife Symbols Foot Print / Arrow

Simboli adesivi da utilizzare per indicare percorsi pedonali.

Disponibili in vari colori.

- Facile applicazione
- Resistente al passaggio di muletti
- Resistente all'abrasione
- Superficie adesiva potente
- Semplice interpretazione

Available in 9 standard colors, designed to identify pedestrian routes.

- Easy to install
- Forklift resistant
- High abrasion resistance
- Excellent adhesion
- Leading the way

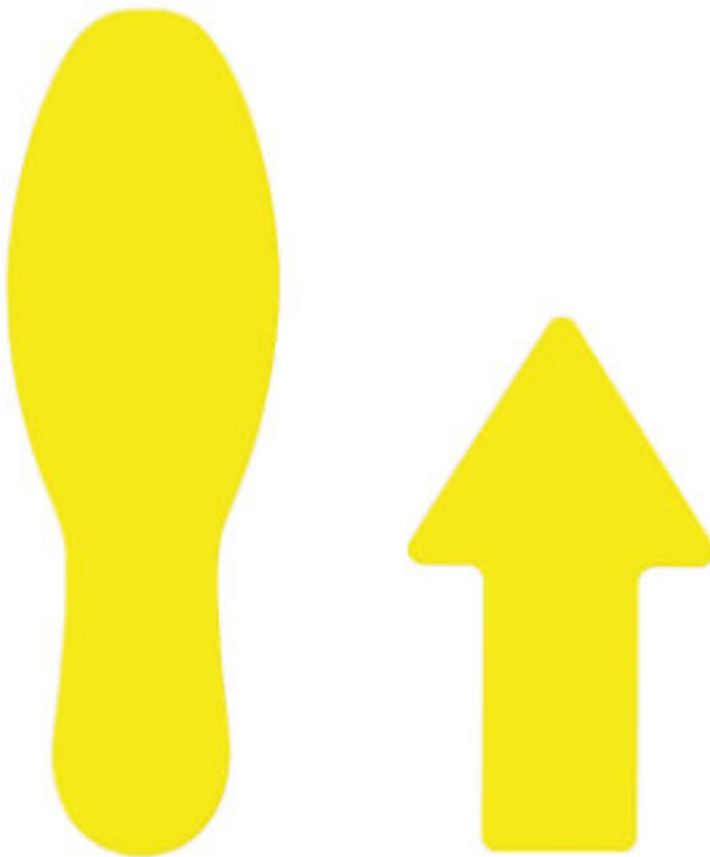



Simboli piede e freccia / LongLife Symbols Foot Print / Arrow

	Dimensione (HxL) (mm) Dimension (WxL) (mm)	Cod. Item-No.	+ Colore + Color	Confezione Pack
Simbolo piede / Foot Print	90 x 280	LGSTP-	01 02 03 04 05 06 07 08 10	50 pezzi / pieces
Simbolo freccia / Arrow	100 x 175	LGPF-	01 02 03 04 05 06 07 08 10	50 pezzi / pieces

LongLife schermo protettivo

LongLife Clearview Floor Frames

Sistema veloce per applicare scritte a pavimento. Disponibile in formati e colori diversi. La stessa durata di tutti i prodotti LongLife.

- Facile applicazione
- Semplice identificazione grazie ai colori
- Eccellente adesione grazie alle ampie aree adesive
- Resistente alle abrasioni
- Materiale antigraffio
- Scansionabile con lettore barcode

Available in 9 colors and different sizes for clear identification of floor storage area.

- Simple application
- Clear identification by color
- Excellent adhesion due to wide adhesive surfaces
- High abrasion resistance
- Scratch-proof material
- Scanner readable QRcode / barcode





LongLife schermo protettivo / LongLife Clearview Floor Frames

Formato int. <i>Int. format</i>	Dimensione esterna (LxH) (mm) <i>External dim. (WxH) (mm)</i>	Cod. <i>Item-No.</i>	+ Colore <i>+ Color</i>	Confezione <i>Pack</i>
DIN A4	400 x 310	LG-KL-A4-	01 02 03 04 05 06 07 08 10	10 pezzi / <i>pieces</i>
1/2 DIN A4	400 x 205	LG-KL-1/2A4-	01 02 03 04 05 06 07 08 10	10 pezzi / <i>pieces</i>
DIN A5	310 x 250	LG-KL-A5-	01 02 03 04 05 06 07 08 10	10 pezzi / <i>pieces</i>
1/3 DIN	310 x 200	LG-KL-1/3DIN-	01 02 03 04 05 06 07 08 10	10 pezzi / <i>pieces</i>
LETTERA	316 x 379	LG-KL-216X279-	01 02 03 04 05 06 07 08 10	10 pezzi / <i>pieces</i>

Simboli non adesivi per classificazione percorsi e zone

Non adhesive classification symbols

Cartoncino stampato non adesivo con simboli da utilizzare in coppia con LongLife - Schermo protettivo, per indicare percorsi o zone specifiche. Disponibili in vari colori per classificare percorsi ed aree.

Non-adhesive printed cardboard with symbols to be used in pairs with LongLife - Protective screen, to indicate specific paths or areas. Available in various colors. Ideal for classifying pedestrian paths or for forklifts.





Pedone
Pedestrian



Muletto
Forklift



Passi
Footprint



Cestino
Basket

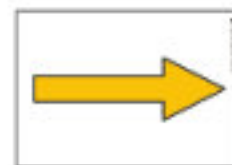

Freccia
Arrow

Simboli per classificazione / Classification symbols

Formato Format	Descrizione Description	Dimensione (LxH) (mm) Dimension (WxH) (mm)	Cod. Item-No.	+ Colore + Color	Confezione Pack
DIN A4	Pedone / Pedestrian	210 x 297	PEDONE-	01 02 03 04 05 06 07 08 10	10 pezzi / pieces
DIN A5	Pedone / Pedestrian	148 x 210	PEDONE/A5-	01 02 03 04 05 06 07 08 10	10 pezzi / pieces
DIN A4	Muletto / Forklift	210 x 297	MULETTO-	01 02 03 04 05 06 07 08 10	10 pezzi / pieces
DIN A5	Muletto / Forklift	148 x 210	MULETTO/A5-	01 02 03 04 05 06 07 08 10	10 pezzi / pieces
DIN A4	Passi / Footprint	210 x 297	PASSI-	01 02 03 04 05 06 07 08 10	10 pezzi / pieces
DIN A5	Passi / Footprint	148 x 210	PASSI/A5-	01 02 03 04 05 06 07 08 10	10 pezzi / pieces
DIN A4	Cestino / Basket	210 x 297	CESTINO-	01 02 03 04 05 06 07 08 10	10 pezzi / pieces
DIN A5	Cestino / Basket	148 x 210	CESTINO/A5-	01 02 03 04 05 06 07 08 10	10 pezzi / pieces
DIN A4	Freccia / Arrow	210 x 297	FRECCIA-	01 02 03 04 05 06 07 08 10	10 pezzi / pieces
DIN A5	Freccia / Arrow	148 x 210	FRECCIA/A5-	01 02 03 04 05 06 07 08 10	10 pezzi / pieces

- Da utilizzare con Schermo protettivo in formato DIN A4 e A5

- For use with DIN A4 and A5 Clearview Floor Frame

LongLife schermo protettivo tondo e freccia

LongLife Clearview Floor Frames

2 differenti forme oltre ai formati standard ma con le medesime caratteristiche con retro adesivo resistente, per una tenuta prolungata anche con forti sollecitazioni.

- Facile applicazione
- Semplice identificazione grazie ai colori
- Eccellente adesione grazie alle ampie aree adesive
- Resistente alle abrasioni
- Materiale antigraffio
- Scansionabile con lettore barcode

2 different shapes in addition to the standard formats but with the same features with strong adhesive backing, for one prolonged hold even with strong stresses.

- *Simple application*
- *Clear identification by color*
- *Excellent adhesion due to wide adhesive surfaces*
- *High abrasion resistance*
- *Scratch-proof material*
- *Scanner readable QRcode / barcode*



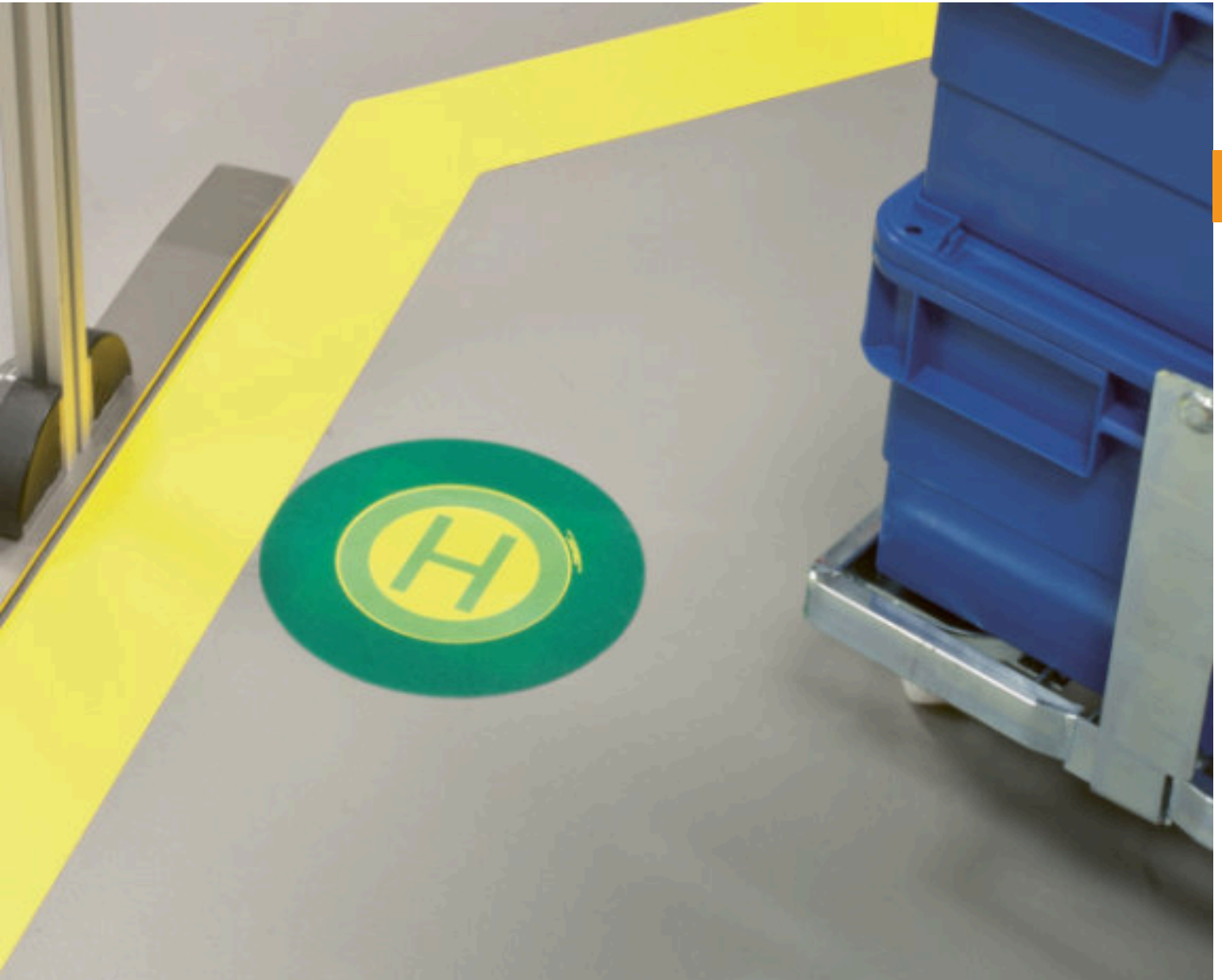

LongLife schermo protettivo / LongLife Clearview Round type and Arrow

Prodotto <i>Designation</i>	Dimensione est. (LxH) (mm) <i>External dim. (WxH) (mm)</i>	Cod. <i>Item-No.</i>	+ Colore <i>+ Color</i>	Cartoncino <i>Cardboards</i>	Confezione <i>Pack</i>
Cerchio / <i>Circle</i>	Ø 210	LG-KL-ROUND-	01 02 03 04 05 06 07 08 10	ET136	10 pezzi / <i>pieces</i>
Freccia / <i>Arrow</i>	320 x 100	LG-KL-FRECCIA-	01 02 03 04 05 06 07 08 10		10 pezzi / <i>pieces</i>

LongLife simboli di classificazione

LongLife Floor Signs 600 mm

Disponibile in formati e colori diversi.

Adesivo resistente per una tenuta

prolungata anche con forti sollecitazioni.

- Realizzato in PVC
- Retro completamente adesivo
- Aumenta la sicurezza sul lavoro
- Facile applicazione
- Eccellente forza adesiva
- Antiscivolo
- Calpestabile
- Alta efficacia visiva
- Diverse tipologie di simboli

Available in different sizes and colors. Strong adhesive for long-lasting hold even under heavy loads.

- Made of PVC
- Back fully covered with adhesive
- Contributes to the safety at work
- Simple application
- Excellent adhesion
- Maximum safety when walked upon
- Accessible for industrial vehicles
- Very good warning / notice effect
- More icons available on request



Simboli di avvertimento e Segnaletica di obbligo conformi alle norme e regolamenti ASRA1.3/BGV, A 8/P07, DIN 4844/P007

Warning icons and mandatory Signs in conformity with norms and regulations ASRA1.3/BGV A 8/P07, DIN 4844/P007



Struttura a 3 strati (stampata sul retro): i simboli di classificazione a pavimento LongLife sono costituiti da una pellicola trasparente stampata sul retro e rivestita con uno speciale adesivo. Ciò significa che l'immagine stampata a colori si trova tra la pellicola e l'adesivo ed è protetta dall'usura.

3-layer structure (back-printed): Multi-colored LongLife Floor Markings consist of a transparent film, which is printed on the back and coated with a special adhesive. This means that the colored printed image is located between film and adhesive and is protected against wear.

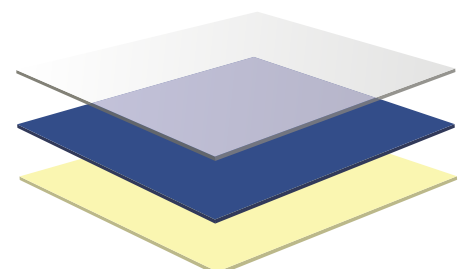



**Divieto di transito
muletti**

Forklift prohibited

Cod. / Item-No.:
LG-SCHILD-600-1

600 mm diametro / diameter



**Divieto di transito
pedoni**

No pedestrian access

Cod. / Item-No.:
LG-SCHILD-600-2

600 mm diametro / diameter



**Vietato
fumare**

No smoking

Cod. / Item-No.:
LG-SCHILD-600-8

600 mm diametro / diameter



**Attenzione
pavimento scivoloso**

Slipping hazard

Cod. / Item-No.:
LG-SCHILD-600-15

520 mm lung. lato / side length



**Divieto accesso ai
non autorizzati**

No access for unauthorized person

Cod. / Item-No.:
LG-SCHILD-600-17

600 mm diametro / diameter



Divieto di sosta

No stopping area

Cod. / Item-No.:
LG-SCHILD-600-16

600 mm diametro / diameter

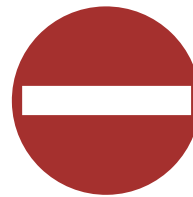

**Divieto di
accesso**

No entry

Cod. / Item-No.:
LG-SCHILD-600-11

600 mm diametro / diameter



**Segnale di
stop**

Stop

Cod. / Item-No.:
LG-SCHILD-600-9

600 mm diametro / diameter



**Obbligo uso di
calzature di sicurezza**

Safety shoes required

Cod. / Item-No.:
LG-SCHILD-600-5

600 mm diametro / diameter



**Obbligo uso occhiali di
protezione**

Safety glasses required

Cod. / Item-No.:
LG-SCHILD-600-6

600 mm diametro / diameter



**Obbligo uso
casco di protezione**

Hard hat area

Cod. / Item-No.:
LG-SCHILD-600-7

600 mm diametro / diameter



**Percorso
pedonale**

Pedestrian route

Cod. / Item-No.:
LG-SCHILD-600-4

600 mm diametro / diameter



Indicatore di direzione

Ahead only

Cod. / Item-No.:
LG-SCHILD-600-10

600 mm diametro / diameter



Obbligo uso gilet catarifrangente

Wear warning vest

Cod. / Item-No.:
LG-SCHILD-600-12

600 mm diametro / diameter



Obbligo uso cuffie di protezione

Wearing ear protection

Cod. / Item-No.:
LG-SCHILD-600-13

600 mm diametro / diameter



Attenzione muletti

Caution forklift truck area

Cod. / Item-No.:
LG-SCHILD-600-3

520 mm lung. lato / side length



Attenzione mantenere distanze di sicurezza

Keep a safe distance

Cod. / Item-No.:
LG-SCHILD-600-19

600 mm diametro / diameter



Obbligo uso mascherina

Wear mask

Cod. / Item-No.:
LG-SCHILD-600-20

600 mm diametro / diameter



Obbligo uso schermo protettivo

Wearing protection screen

Cod. / Item-No.:
LG-SCHILD-600-21

600 mm diametro / diameter



Attenzione carichi sospesi

Caution suspended loads

Cod. / Item-No.:
LG-SCHILD-600-64

520 mm lung. lato / side length

Su www.LeanProducts.eu troverai tutti i segnali di obbligo e divieto dell'ASR A1.3 (DIN EN ISO 7010) necessari per una designazione conforme alla norma nella tua azienda.

At LeanProducts.eu you will find all mandatory and prohibition signs of the ASR A1.3 (DIN EN ISO 7010) that are necessary for a standard-compliant designation in your company.



LongLife freccia fluorescente

LongLife Arrow Luminescent

Simbolo freccia fluorescente ben visibile in un ambiente poco illuminato. Fornisce orientamento di sicurezza.

- Facilità di utilizzo
- Resistenza alle abrasioni e ai lavaggi
- Lunga durata
- Resistenza al passaggio dei muletti
- Design economico
- Diametro 90 mm
- Superficie antistrappo

Self-adhesive guidance system for indoor use.

The luminescent symbol serves as an additional orientation guide.

- Easy to use
- Scratch resistant front surface
- Long endurance
- Forklift resistant
- Economic design
- Diameter 90 mm
- Anti-tear

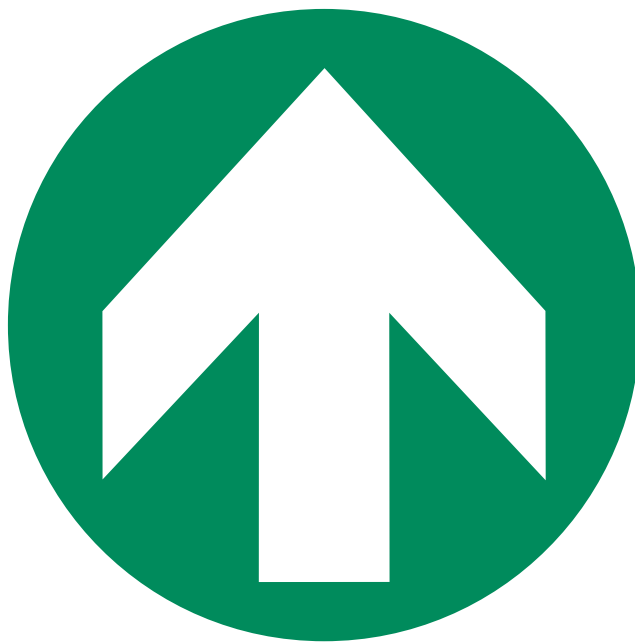

ORGATEX®



LongLife freccia fluorescente / *LongLife Arrow Luminescent*

Dimensione (mm)
Dimension (mm)

Cod.
Item-No.

Confezione
Pack

Ø 90

LGN-90-PP

20 pezzi / *pieces*

LongLifeHD simboli per delimitazione

LongLife Symbols Heavy Duty

Ideali per delimitare i passaggi e le zone di stoccaggio maggiormente esposti a usura. L'alta qualità del materiale e le estremità arrotondate rendono il prodotto resistente e funzionale.

- Facile applicazione
- Resistente alle abrasioni
- Prodotto brevettato

Our LongLifeHeavyDuty Floor Markings are perfect for marking path ways and storage spaces, which are exposed to extremely high levels of traffic. The combination of high-quality material and beveled edges provides resistance and functionality.

- Excellent adhesion
- Heavy duty
- Forklift resistant

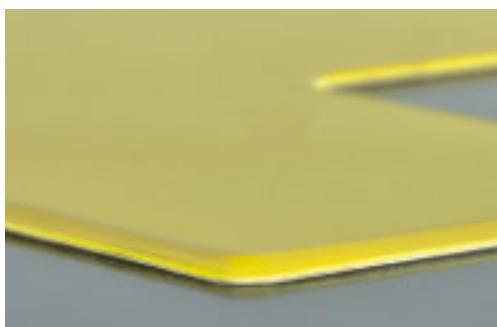



LongLife HD simboli per delimitazione / LongLife Symbols Heavy Duty

	Dimensione (HxL) (mm) Dimension (WxL) (mm)	Cod. Item-No.	+ Colore + Color	Confezione Pack
Elemento a T / T-Shape	50	LGHD-50-T-	01 02 03 04 05 06 08 10	20 pezzi / pieces
Elemento a L / L-Shape	50	LGHD-50-L-	01 02 03 04 05 06 08 10	20 pezzi / pieces
Elemento diritto / Longitudinal marking	50 x 250	LGHD-50250-	01 02 03 04 05 06 08 10	20 pezzi / pieces

LongLifeHD rounded simboli per delimitazione

LongLife Symbols Heavy Duty Rounded

Ideali per delimitare i passaggi e le zone di stoccaggio maggiormente esposti a usura. L'alta qualità del materiale e le estremità arrotondate rendono il prodotto resistente e funzionale

- Facile da applicare
- Resistente alle abrasioni
- Prodotto brevettato

Our LongLife Heavy Duty Floor Markings are perfect for marking path ways and storage spaces, which are exposed to extremely high levels of traffic. The combination of high-quality material and beveled edges provides resistance and functionality.

- Excellent adhesion
- Heavy duty
- Forklift resistant

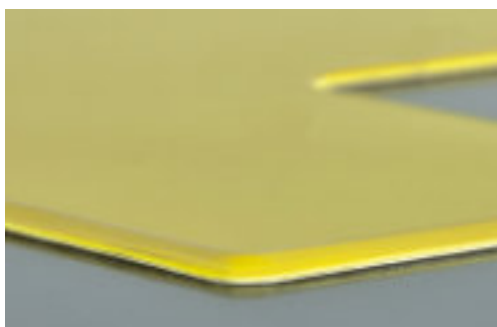



LongLife HD rounded simboli per delimitazione / LongLife Symbols Heavy Duty Rounded

	Dimensione (HxL) (mm) Dimension (WxL) (mm)	Cod. Item-No.	+ Colore + Color	Confezione Pack
Elemento a T / T-Shape	90	LGRHD-90-T-	01 02 03 04 05 06 08 10	20 pezzi / pieces
Elemento a L / L-Shape	90	LGRHD-90-L-	01 02 03 04 05 06 08 10	20 pezzi / pieces
Elemento rotondo / Point	90	LGRHD-90-P-	01 02 03 04 05 06 08 10	20 pezzi / pieces
Elemento diritto / Longitudinal marking	50 x 450	LGRHD-90450-	01 02 03 04 05 06 08 10	20 pezzi / pieces

LongLife MODUL

LongLife MODULE

Moduli in plastica extra resistente per zone di stoccaggio gravose e per utilizzo in ambienti esterni.

- Extra robusto
- Antigraffio
- Disponibile in versione con adesivo extraforte o con adesivo extraforte e foro per fissaggio permanente (6 x 40 mm).

Extremely robust marking plates for bulk storage and other heavy duty areas. LongLife MODULE, coated with a special adhesive, made of high quality, non breakable plastic, which results in extreme durability.

- Heavy duty
- Scratch-proof
- Self-adhesive, additional punch holes for anchors (6 x 40 mm) available

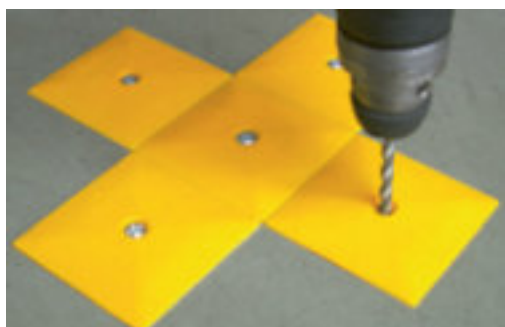



LongLife MODUL / LongLife MODULE

	Dimensione (HxL) (mm) Dimension (WxL) (mm)	Cod. Item-No.	+ Colore + Color	Confezione Pack
LongLife MODUL adesivo / Square	75 x 75	LGMOD-SK-	01 02 03 04 05 08 10	50 pezzi / pieces
LongLife MODUL adesivo + foro / Square with perforation	75 x 75	LGMOD-ND-	01 02 03 04 05 08 10	50 pezzi / pieces
Vite e tassello / Hammer in anchor	6 x 40	LG6X40ND		50 pezzi / pieces

LongLife MODUL a L

LongLife MODULE L-Angle

Simbolo per delimitazione extra forte consigliato dove c'è un alto rischio di usura.

- Per uso interno ed esterno
- Facile da applicare, anche su pavimento unto
- Resistente al passaggio dei muletti
- Antigraffio
- Viteria inclusa

The robust marking symbol is designed for high levels of traffic.

- For indoor and outdoor use*
- Heavy duty*
- Easy to install, even on bumpy or oily surfaces*
- Forklift resistant*
- Scratch-proof*
- Attachment material included*





LongLife MODUL a L / LongLife MODULE L-Angle

	Dimensione (mm) Dimension (mm)	Cod. Item-No.	+ Colore + Color	Confezione Pack
LongLife MODUL a L / L-Angle	50	LGMOD-L-	01 02 03 04 05 08 10	20 pezzi / pieces

LongLife Cold Performance

LongLife Cold Performance

Il nostro nuovo sistema di marcatura per pavimenti LongLife Cold Performance è adatto per contrassegnare parcheggi, aree pericolose o vie di fuga. È stato sviluppato appositamente per ambienti industriali con temperature ambiente estremamente basse.

- Resistente fino a temperature di -20°C
- Elevato potere adesivo e di tenuta nelle zone fredde
- Facile applicazione
- Molto resistente
- Applicabile nei progetti 5S nel settore surgelati
- Disponibile in diverse colorazioni e formati

Our new LongLife Cold Performance floor marking system is suitable for marking driveways, parking spaces, dangerous areas or escape routes. It has been developed especially for industrial environments with extremely low ambient temperatures.

- Bonding temperature down to -20°C
- High adhesive strength and holding power in cold areas
- Easy attachment
- High resilience
- 5S projects in frozen food areas
- Available in many colours and designs



LongLife CP simboli di delimitazione / LongLife Cold Performance Symbols

	Dimensione <i>Dimension</i>	Cod. <i>Item-No.</i>	+ Colore <i>+ Color</i>	Confezione <i>Pack</i>
	Elemento a T / T-Piece	50 mm	LGCP-50-T-	01 02 03 04 05 06 07 08 10 50 pezzi / pieces
	Elemento a L / L-Angle	50 mm	LGCP-50-L-	01 02 03 04 05 06 07 08 10 50 pezzi / pieces
	Elemento dritto / Long.	50 x 250 mm	LGCP-50250-	01 02 03 04 05 06 07 08 10 50 pezzi / pieces
	Elemento a T / T-Piece	75 mm	LGCP-75-T-	01 02 03 04 05 06 07 08 10 50 pezzi / pieces
	Elemento a L / L-Angle	75 mm	LGCP-75-L-	01 02 03 04 05 06 07 08 10 50 pezzi / pieces
	Elemento diritto / Long.	75 x 350 mm	LGCP-75350-	01 02 03 04 05 06 07 08 10 50 pezzi / pieces

LongLife CP schermi protettivi / LongLife Cold Performance Clearview Floor Frames

	Dimensione <i>Dimension</i>	Cod. <i>Item-No.</i>	+ Colore <i>+ Color</i>	Confezione <i>Pack</i>
	DIN A4	400 x 310 mm	LGCP-KL-A4-	01 02 03 04 05 06 07 08 10 10 pezzi / pieces
	1/2 DIN A4	400 x 205 mm	LGCP-KL-1/2A4-	01 02 03 04 05 06 07 08 10 10 pezzi / pieces
	DIN A5	310 x 250 mm	LGCP-KL-A5-	01 02 03 04 05 06 07 08 10 10 pezzi / pieces
	1/3 DIN	310 x 200 mm	LGCP-KL-1/3DIN-	01 02 03 04 05 06 07 08 10 10 pezzi / pieces

LongLife CP rounded simboli di delimitazione / LongLife Cold Performance Symbols Rounded

	Dimensione <i>Dimension</i>	Cod. <i>Item-No.</i>	+ Colore <i>+ Color</i>	Confezione <i>Pack</i>
	Elemento a T / T-Piece	90 mm	LGRC-90-T-	01 02 03 04 05 06 07 08 10 50 pezzi / pieces
	Elemento a L / L-Angle	90 mm	LGRC-90-L-	01 02 03 04 05 06 07 08 10 50 pezzi / pieces
	Elemento diritto / Long.	90 x 450 mm	LGRC-90450-	01 02 03 04 05 06 07 08 10 50 pezzi / pieces
	Elemento rotondo / Point	90 mm	LGRC-90-P-	01 02 03 04 05 06 07 08 10 50 pezzi / pieces

Proiettore eOX-Spot

eOX-Spot

Proiettore LED per garantire un ambiente di lavoro sicuro

eOX-Spot è uno strumento sviluppato con lo scopo di ridurre le situazioni potenzialmente pericolose in ambito lavorativo. Il proiettore eOX-Spot può essere settato con estrema semplicità per proiettare i segnali di sicurezza su qualunque superficie. eOX-Spot è orientabile per proiettare il simbolo nella posizione desiderata indipendentemente dalle condizioni del terreno. Grazie al LED ad alta potenza da 40 Watt la proiezione è chiaramente visibile anche in ambienti luminosi e l'alimentatore è già integrato.

Oltre alla sua funzione di strumento di sicurezza indispensabile, può anche essere utilizzato con finalità legate al marketing e alla Brand reputation.

- Semplice assemblaggio
- Potente LED da 40W o da 80W
- Semplicità nella sostituzione dei simboli
- Versatile nei possibili utilizzi
- Alimentatore integrato da 230V
- Alta efficienza energetica



Modern LED tool to ensure a safe work environment

Avoid hazardous situations with the light projector for warning signals: The eOX-Spot with integrated power supply. Not only can it be equipped with common safety and warning signals, but also with individual motifs. The eOX-Spot is versatile and can be adapted to any progress as well as any change. Regardless of the ground condition, the swiveling projector casts the required label on the desired location. Due to the high-power LED containing 40 Watts, the projection is clearly visible even in bright environments.

Freshen up your marketing efforts

Besides its function as an indispensable safety tool, you can also use this powerful projector for attention-grabbing marketing. So e.g., your company logo will become a real eye-catcher

- Simple assembly
- High power LED with 40W or 80W
- Easily replaceable motifs
- Versatile use
- Integrated power supply for 230V
- High energy efficiency
- No abrasion

- Alta efficienza energetica
- High energy efficiency

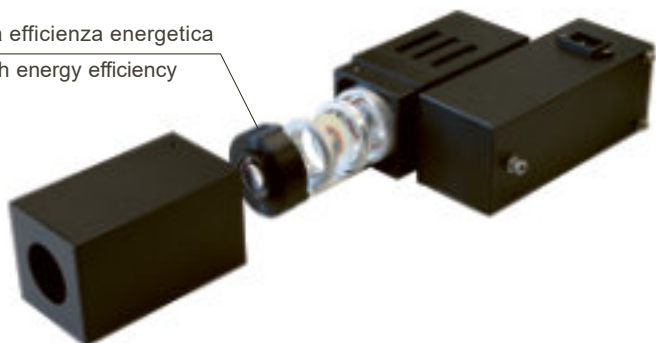



Proiettore eOX-Spot / *eOX-Spot*

Cod.
Item-No.

eOX-Spot LED 40w

EOX-SPOT-40

eOX-Spot LED 80w

EOX-SPOT-80

Segnaletica orizzontale / Floor Markings

eOX SPOT 40 Illuminazione [lux] / Illuminance

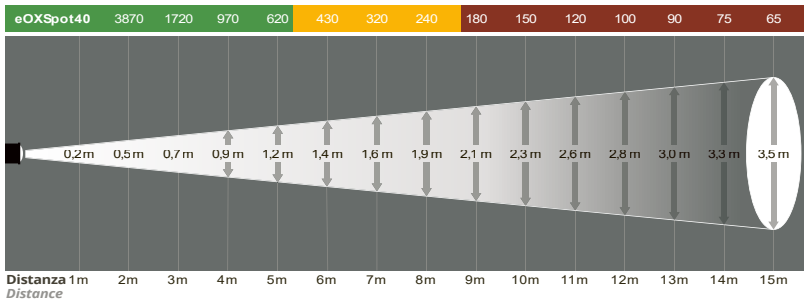

eOX SPOT 80 Illuminazione [lux] / Illuminance

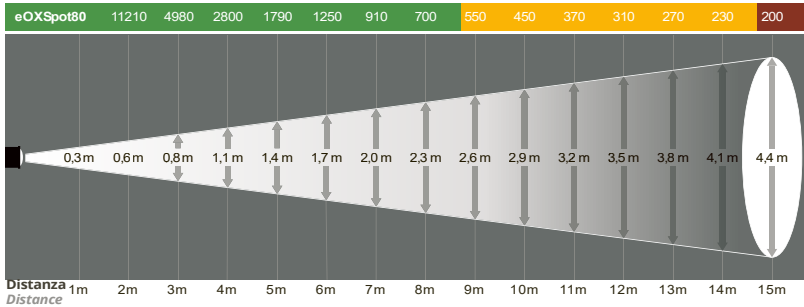

Simboli standard per proiettore eOX-Spot

Standard motifs



**Divieto di
transito muletti**

Forklift prohibited

Cod. / Item-No.:
EOX-SPOT-M-1
EOX-SPOT-80-M-1



**Divieto di
transito pedoni**

No pedestrian access

Cod. / Item-No.:
EOX-SPOT-M-2
EOX-SPOT-80-M-2



**Attenzione
muletti**

Caution forklift truck area

Cod. / Item-No.:
EOX-SPOT-M-3
EOX-SPOT-80-M-3



**Percorso
pedonale**

Pedestrian route

Cod. / Item-No.:
EOX-SPOT-M-4
EOX-SPOT-80-M-4



**Segnale di
Stop**

Stop

Cod. / Item-No.:
EOX-SPOT-M-9
EOX-SPOT-80-M-9



**Divieto accesso ai
non autorizzati**

No trespassing

Cod. / Item-No.:
EOX-SPOT-M-17
EOX-SPOT-80-M-17

Simboli personalizzabili proiettore eOX-Spot

Individual motifs



Bianco e nero

Motif without colour

Cod. / Item-No.:

EOX-SPOT-MI-SW



1 Colore

Motif single colour

Cod. / Item-No.:

EOX-SPOT-MI-1



2 Colori

Motif two colours

Cod. / Item-No.:

EOX-SPOT-MI-2



3 Colori

Motif three colours

Cod. / Item-No.:

EOX-SPOT-MI-3



4 Colori

Motif four colours

Cod. / Item-No.:

EOX-SPOT-MI-4



Traffico di carrelli elevatori, divieto di accesso, percorsi pedonali e molto altro: i segnali di avvertimento e informativi sono regolarmente richiesti nell'industria manifatturiera e in molti altri settori. Troverai molti simboli già pronti per le situazioni standard nella nostra selezione e con la possibilità di crearne di personalizzati.

Forklift traffic, no admittance, pedestrians and much more: In the manufacturing industry, as well as in many other sectors, warning and information signs are required on a regular basis. For standard situations, you will find ready-made motifs in our product range. Individual motifs are also possible.

Dai l'informazione più corretta con il formato migliore: etichettatura versatile e flessibile con le nostre soluzioni cornici e tabelle informative

Giving the most important information the right frame: versatile and exible labeling with our poster frame solutions

Cornici e tabelle informative

Hanging Signs

Le persone sono orientate visivamente e acquisiscono l'80% di tutte le informazioni con gli occhi. Ciò rende gli strumenti di visualizzazione sul posto di lavoro ancora più importanti, ad esempio per contrassegnare i depositi e i parcheggi o per trasmettere informazioni in modo chiaramente visibile.

Le cornici informative per sospensione sono uno strumento versatile per la visualizzazione.

Sono più leggere dei telai convenzionali e hanno un'elevata resistenza grazie al loro robusto telaio in plastica.

Possono essere utilizzate anche in aree industriali molto frequentate. Inoltre la copertura protettiva antiriflesso in PVC può essere letta da tutti gli scanner disponibili in commercio. Le cornici Informative per sospensione sono disponibili in tutti i comuni formati DIN e in otto diversi colori.

Possono essere utilizzate su entrambi e in formato orizzontale.

Con i nostri numerosi accessori, le cornici possono essere collegate, sospese e agganciate. Puoi fissarle in vari modi, anche su pareti e soffitti, contenitori, scatole e/o scatole in rete, a seconda delle tue esigenze individuali.

People are visually oriented and take in 80% of all information with their eyes. This makes visualization tools at the workplace all the more important, for example to mark storage and parking spaces or to convey important information in a clearly visible manner.

Hanging signs are a versatile tool for visualization. They are lighter than conventional frames and have a high resistance due to their robust plastic frame. Therefore, they can also be used in highly frequented industrial areas. In addition, the anti-reflective protective cover made of PVC can be read by all commercially available scanners.

Hanging signs are available in all common DIN formats and in eight different colors. They can be used on both sides and in both portrait and landscape format. With our extensive accessories, the frames can be connected or attached, suspended and clipped on. You can attach them in a variety of ways, including on walls and ceilings, containers, boxes and or mesh boxes - depending on your individual needs. This means that

Ciò significa che i nostri cartelli sospesi ti consentono di essere estremamente flessibile, perché anche il montaggio e lo scambio di informazioni è semplice e veloce. Grazie alla clip di bloccaggio brevettata, si evita l'uscita involontaria del documento.

Oltre all'ampia gamma di cartelli sospesi, offriamo anche un set completo per la sospensione 5S, che facilita l'applicazione dei metodi 5S, e tabelle informative in alluminio per l'esposizione di documenti in formato DIN.

our hanging signs allow you to be extremely flexible, Because the assembly and exchange of information is also quick and easy. Thanks to the patented locking clip, they offer a secure hold.

In addition to the extensive range of hanging signs, Offer you a complete set for 5S suspension which makes it easier to follow the 5S methods, and aluminum snap frames for the safe storage of posters in DIN format.

ORGATEX®



Cornici informative
Hanging Signs



Sistema a sospensione 5S
5S Suspension system



Accessori per cornici informative
Hanging Signs Accessories



Tabelle informative in alluminio
Aluminium SnapFrames

Cornici e tabelle informative

Infographic Hanging Signs



Facile e veloce
Fast and easy fitin



Leggeri
Low Weight



Documenti sempre
protetti
*Documents are protected
from impurities and weather*

ORGATEX®

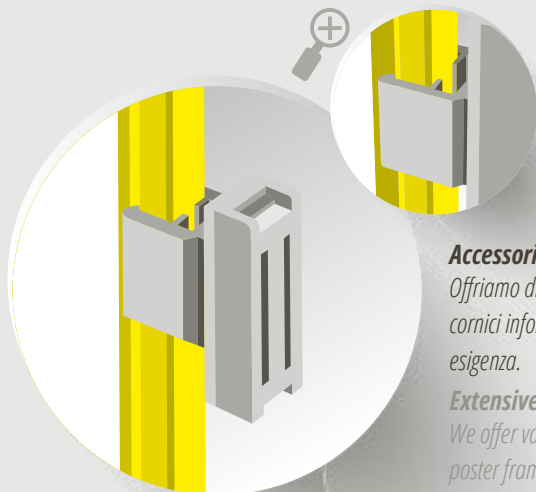

Accessori

Offriamo diverse opzioni di montaggio per le cornici informative. Pensate per ogni esigenza.

Extensive accessories

We offer various mounting options for the poster frames. These are specially tailored to your individual needs.

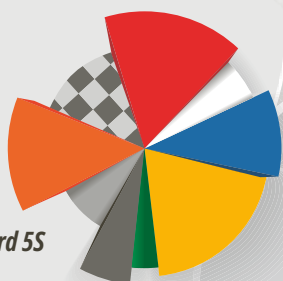

Colori standard 5S
Standard 5S colors



Stampa su carta standard (DIN)

Printout on standard paper (DIN)



Formato standard DIN

DIN formats

DIN



5S Sistema di sospensione

Set progettato per eliminare errori e gestire al meglio le risorse. Il set completo è composto da: cornici e tavole informative, clip per fissaggio al profilo, passanti per appendere e il profilo stesso.

5S suspension

For the enabling of trouble-free processes by observing rules. The complete set consists of: poster frames, round tube clips, eyelet clips and round-tube.

Copertura antiriflesso in PVC

Semplice e veloce cambiare l'informazione contenuta nella cornice. Può essere scansionata.

Anti-glare protective cover made of PVC

Flexible and fast exchange of information.

Can be read by any scanner. **DIN A1**

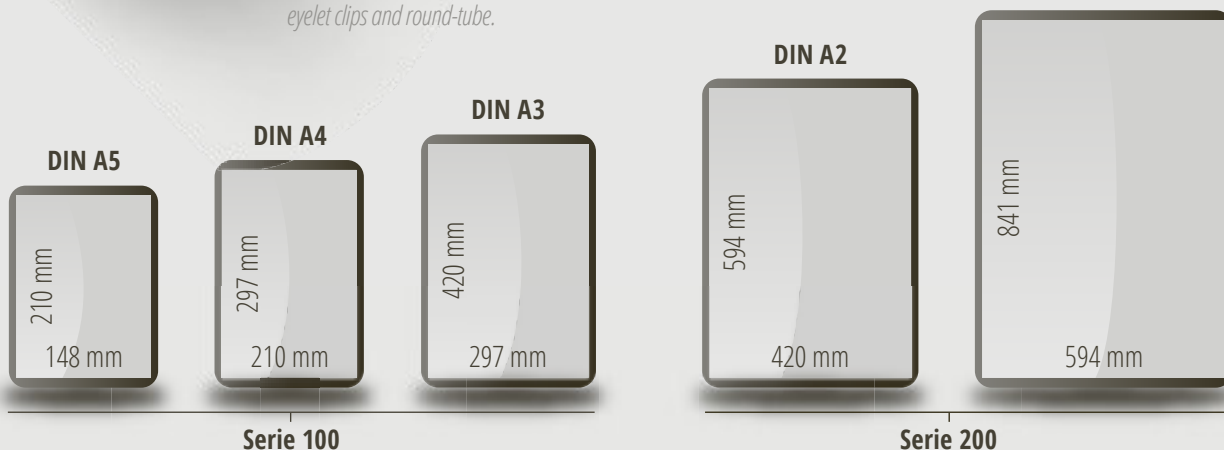

Cornici Serie 100 / 200

Hanging Signs Series 100 / 200

Cornici informative colorate con copertura protettiva antiriflesso, leggibile da entrambi i lati. Dotate di clip di chiusura. Disponibili innumerevoli accessori per quasi tutte le esigenze di montaggio richieste. Perfette per l'identificazione dei prodotti a distanza in ambienti molto ampi quali magazzini.

- Cornici resistenti
- PVC trasparente antiriflesso scansionabile
- Innumerevoli accessori
- Utilizzabili in formato orizzontale o verticale

Colored information frames with anti-reflection protective cover, readable from both sides. Equipped with closing clips. Countless accessories are available for almost all the required assembly needs. Perfect for remote product identification in very large environments such as warehouses.

- Robust plastic frame (suitable for industrial purposes)
- AR coated cover (can be scanned)
- Available in all customary Inch and DIN formats
- Use in portrait or landscape format





Cornici Serie 100 / 200 / Hanging Signs Series 100 / 200

	Dimensioni int. / est. (mm) Inner / outer dim. (WxH) (mm)	Cod. Item-No.	+ Colore + Color	Confezione Pack
DIN A5 (S100)	148 x 210 / 153 x 218	PKR-A5-100-	01 02 03 04 05 06 07 08	5 pezzi / pieces
DIN A4 (S100)	210 x 297 / 217 x 305	PKR-A4-100-	01 02 03 04 05 06 07 08	5 pezzi / pieces
DIN A3 (S100)	297 x 420 / 305 x 427	PKR-A3-100-	01 02 03 04 05 06 07 08	5 pezzi / pieces
DIN A2 (S200)	420 x 594 / 430 x 600	PKR-A2-200-	- - - - - 07 -	5 pezzi / pieces
DIN A1 (S200)	594 x 841 / 600 x 846	PKR-A1-200-	- - - - - 07 -	5 pezzi / pieces

Accessor Serie 100

Accessories Serie 100

Supporto per tubo S100 / S100 Tube Clamp (for PKR-CL-AP-100)

		Cod. Item-No.	Serie Serie	Confezione Pack
 		PKR-CL-RKW-100	100	10 pezzi / pieces
	<ul style="list-style-type: none"> - Plastica bianca - Supporto per tubo Ø 23-28 mm - Necessita dell'adattatore PKR-CL-AP-100 		<ul style="list-style-type: none"> - White plastic Tube Clamp for attaching Hanging Signs to tubes with a diameter of 23-28 mm - For use with Parallel Adapter PKR-CL-AP-100 	

Adattatore S100 / S100 Parallel Adapter

		Cod. Item-No.	Serie Serie	Confezione Pack
 		PKR-CL-AP-100	100	10 pezzi / pieces
	<ul style="list-style-type: none"> - Plastica trasparente robusta - Adattatore per PKR-CL-RKW-100 		<ul style="list-style-type: none"> - Parallel Adapter for the mounting of the Hanging Signs in connection with Tube Clamp 23-28 mm diameter tube (PKR-CL-RKW-100) 	



Connettore per esecuzione a cubo S100 / S100 Twin Holder: 90°

		Cod. Item-No.	Serie Serie	Confezione Pack
 		PKR-CL-VA-100	100	10 pezzi / pieces
	<ul style="list-style-type: none"> - Plastica trasparente robusta 		<ul style="list-style-type: none"> - Transparent plastic hinge for 4 sided Hanging Sign display 	

Supporto per ceste metalliche S100 / S100 Grid Hook: Pair

		Cod. Item-No.	Serie Serie	Confezione Pack
 		PKR-CL-GH-100	100	10 paia / pairs
	<ul style="list-style-type: none"> - Per ceste metalliche con filo 10 mm spessore - Plastica trasparente robusta 		<ul style="list-style-type: none"> - Transparent plastic Grid Hooks for parallel mounting of Hanging Signs to wire grids of up to 10 mm in diameter 	

Supporto magnetico S100 / S100 Swivel Magnet

		Cod. Item-No.	Serie Serie	Confezione Pack
 		PKR-CL-MAD-100	100	10 pezzi / pieces
		<ul style="list-style-type: none"> - Plastica trasparente robusta - Ruota 360° - Portata massima 2,8 kg 		<ul style="list-style-type: none"> - Transparent plastic holder with magnet assembly and 360° rotation - Holds approximately 2,8 kg of weight

Morsetto S100 / S100 Clamp Holder

		Cod. Item-No.	Serie Serie	Confezione Pack
 		PKR-CH-100	100	20 pezzi / pieces
		<ul style="list-style-type: none"> - Adatto per tubi, contenitori ecc. - Da utilizzare con PKR-CL-T60-100 		<ul style="list-style-type: none"> - White plastic Clamp Holder for use with T-Piece (PKR-CL-T60-100) to attach Hanging Signs to folding or flat boxes

Supporto a T S100 / S100 T-Piece (for PKR-CH-100 / 60 mm)

		Cod. Item-No.	Serie Serie	Confezione Pack
 		PKR-CL-T60-100	100	20 pezzi / pieces
		<ul style="list-style-type: none"> - Da utilizzare con PKR-CH-100 		<ul style="list-style-type: none"> - White plastic T-Piece for use in connection with Clamp Holder (PKR-CH-100)

Supporto girevole S100 / S100 Swivel Wall Mount

		Cod. Item-No.	Serie Serie	Confezione Pack
 		PKR-CL-SHD-100	100	10 pezzi / pieces
		<ul style="list-style-type: none"> - Con 2 fori di fissaggio - Plastica trasparente robusta - Ruota a 360° 		<ul style="list-style-type: none"> - Transparent plastic Swivel Wall Mount with 360° rotation for securing Hanging Signs to walls

Accessori Serie 100

Accessories Serie 100

Clip di chiusura S100 / S100 Closing Clip

		Cod. Item-No.	Serie Serie	Confezione Pack
		PKR-CL-VS-100	100	10 pezzi / pieces
		- Plastica trasparente robusta		- Transparent plastic Closing Clip prevents inlet from sliding out of the Hanging Sign



Supporto a gancio S100 / S100 Swivel Hook

		Cod. Item-No.	Serie Serie	Confezione Pack
		PKR-CL-HK-100	100	10 pezzi / pieces
		- Plastica trasparente robusta- - Per collegarsi a PKR-KK e PKR-CL-OED-100 - Ruota a 360°		- Transparent plastic Swivel Hook with 360° rotation for Hanging Signs

Supporto ad anello girevole S100 / S100 Swivel Loop

		Cod. Item-No.	Serie Serie	Confezione Pack
		PKR-CL-OED-100	100	10 pezzi / pieces
		- Plastica trasparente robusta - Ruota a 360°		- Transparent plastic Swivel Loop with 360° rotation for suspending the Hanging Signs

Supporto a muro S100 / S100 Self-Adhesive Wall Mount

		Cod. Item-No.	Serie Serie	Confezione Pack
		PKR-CL-WH-100	100	10 pezzi / pieces
		- Supporto a muro con adesivo e fori per fissaggio - Plastica trasparente robusta		- Transparent plastic self-adhesive Wall Mount includes hole for screw to secure to wall

Supporto ad inserimento S100 / S100 Box Clamp with Adjustable Angle

		Cod. Item-No.	Serie Serie	Confezione Pack
 		PKR-CL-KK-100	100	10 pezzi / pieces
		<ul style="list-style-type: none"> - Supporto ad inserimento fino a 20 mm - Plastica trasparente robusta 		<ul style="list-style-type: none"> - Transparent plastic Box Clamp with Adjustable Angle for the mounting of Hanging Signs to folding / flat boxes of up to 20 mm of material thickness

Connettore girevole S100 / S100 Swivel Frame Connector Rotatable

		Cod. Item-No.	Serie Serie	Confezione Pack
 		PKR-CL-VB-100	100	10 pezzi / pieces
		<ul style="list-style-type: none"> - Plastica trasparente robusta con 360° di rotazione 		<ul style="list-style-type: none"> - Transparent plastic Swivel Frame Connector with 360° rotation for connecting a series of Hanging Signs

Kit supporto a muro per 5 cornici S100 / S100 Wall Mounting System Rotatable

		Cod. Item-No.	Serie Serie
 		PKR-WHB-100	100
		<ul style="list-style-type: none"> - Plastica trasparente robusta - Kit composto da: 1 x supporto superiore a muro 1 x supporto inferiore a muro 10 x perni 	

Accessori Serie 100 / 200

Accessories Series 100 / 200

Clip universale S100 / S200 / S100 / S200 Adjustable Frame Holder (for PKR-RK-28, PKR-MH, PKR-SKH-30)

	Cod. Item-No.	Serie Series	Confezione Pack
 	PKR-RCL-100	100	10 pezzi / pieces
	PKR-RCL-200	200	10 pezzi / pieces
- Da utilizzare con PKR-RK-28, PKR-MH e PKR-SKH-30			- Transparent frame holder with spindle holder, allows rotation - To be used with PKR-RK-28, PKR-MH, PKR-SKH-30

Clip universale 90° S100 / S200 / S100 / S200 Adjustable Frame Holder 90° rotatable (for PKR-RK-28, PKR-MH, PKR-SKH-30)

	Cod. Item-No.	Serie Series	Confezione Pack
 	PKR-RCL90-100	100	10 pezzi / pieces
	PKR-RCL90-200	200	10 pezzi / pieces
- Plastica trasparente robusta con aggancio ruotato di 90° - Da utilizzare con PKR-RK-28, PKR-MH, PKR-SKH-30			- Transparent frame holder with spindle holder, allows 90° rotation - To be used with PKR-RK-28, PKR-MH, PKR-SKH-30

Aggancio per tubo Ø 28 / Round Tube Clip

	Cod. Item-No.	Serie Series	Confezione Pack
 	PKR-RK-28	100 / 200	10 pezzi / pieces
	- Da utilizzare con PKR-RCL-100 - Da utilizzare con PKR-RCL-200		

Aggancio magnetico / Magnetic Frame Holder

	Cod. Item-No.	Serie Series	Confezione Pack
 	PKR-MH	100 / 200	10 pezzi / pieces
	- Da utilizzare con PKR-RCL-100 - Da utilizzare con PKR-RCL-200		

Aggancio adesivo / Self-Adhesive Frame Holder

	Cod. <i>Item-No.</i>	Serie <i>Series</i>	Confezione <i>Pack</i>
		<p>PKR-SKH-30</p>	<p>100 / 200 10 pezzi / pieces</p> <ul style="list-style-type: none"> - Da utilizzare con PKR-RCL-100 - Da utilizzare con PKR-RCL-200 - Plastica trasparente con adesivo ad alta performance su tutta la superficie <ul style="list-style-type: none"> - Transparent self-adhesive frame holder, high adhesive performance on most at surfaces - To be used with PKR-RCL-100 / 200

Accessori Serie 200

Accessories Serie 200

Connettore con esecuzione a cubo / triangolo S200 / S200 Film Hinge

		Cod. Item-No.	Serie Serie	Confezione Pack
		PKR-CL-FS-200	200	10 pezzi / pieces
		<ul style="list-style-type: none"> - Plastica trasparente robusta - Per cornici S200 (DIN A, DIN A2) 		<ul style="list-style-type: none"> - Transparent plastic Film Hinge for 3 sided or 4 sided Hanging Sign display (Series 200)

Supporto magnetico S200 / S200 Swivel Magnet

		Cod. Item-No.	Serie Serie	Confezione Pack
		PKR-CL-MAD-200	200	10 pezzi / pieces
		<ul style="list-style-type: none"> - Supporto magnetico S200 - Portata massima 2,8 Kg - Ruota a 360° 		<ul style="list-style-type: none"> - Transparent plastic holder with magnet suitable for mounting Hanging Signs to metal surfaces, rotates 360° - Holds approximately 2.8 kg

Supporto a muro S200 / S200 Self-Adhesive Wall Mount

		Cod. Item-No.	Serie Serie	Confezione Pack
		PKR-CL-WH-200	200	10 pezzi / pieces
		<ul style="list-style-type: none"> - Supporto a muro con adesivo - Plastica trasparente robusta 		<ul style="list-style-type: none"> - Transparent plastic, self adhesive Wall Mount for a xing Hanging Signs to a wall - With double-sided tape

Clip di chiusura S200 / S200 Closing Clip

		Cod. Item-No.	Serie Serie	Confezione Pack
		PKR-CL-VS-200	200	10 pezzi / pieces
		- Plastica trasparente robusta		- Transparent plastic Closing Clip prevents transparent inlet from sliding out of the Hanging Sign

Supporto ad anello girevole S200 / S200 Swivel Loop



		Cod. Item-No.	Serie Serie	Confezione Pack
		PKR-CL-OED-200	200	10 pezzi / pieces
		- Plastica trasparente robusta - Ruota a 360°		- Transparent plastic Swivel Loop with 360° rotation for suspending the Hanging Signs

Supporto girevole S200 / S200 Swivel Wall Mount

		Cod. Item-No.	Serie Serie	Confezione Pack
		PKR-CL-SHD-200	200	10 pezzi / pieces
		- Plastica trasparente robusta - Con 2 fori di fissaggio - Ruota a 360°		- transparent plastic Swivel Wall Mount with 360° rotation to mount Hanging Signs to walls

Accessori comuni Common Accessories

Tubo L = 2420 mm / Steel Tube = 2420 mm

		Cod. Item-No.	Dimensione (L) Dimension (Length)
		PKR-R28	2420 mm
		<p>- Tubo metallico ricoperto in PVC grigio Ø 28 mm con inclusi 2 tappi in PVC nero</p> <p>- Silver grey Steel Tube includes black PVC end caps, Length 2420 mm, Ø 28 mm</p>	

Tappi per tubo Ø 28 mm / End Caps Ø 28 mm for Steel tube

		Cod. Item-No.	Confezione Pack
		PKR-RES-28	10 pezzi / pieces
		<p>- Tappi in PVC nero</p> <p>- Black end cap for tube suspension</p>	

Connettore per tubo 100 mm / Connector for Steel tube 100 mm

		Cod. Item-No.	
		PKR-RV28	
		<p>- Connettore in materiale plastico</p> <p>- Connector PVC with metal core allows to connect steel tubes</p>	

Aggancio a S / S-Hook

		Cod. Item-No.	Confezione Pack
		PKR-SHK	10 pezzi / pieces
		<p>- Materiale metallico</p> <p>- Aggancio a S per catena metallica</p> <p>- Metal S-Hook to use with chain for the suspension of Hanging Signs</p>	

Magnete con aggancio / Ceiling Magnet with Hook

Cod.
Item-No.

PKR-DM50-02



- Magnete con aggancio con portata 12 kg

- White Ceiling Magnet with Hook for suspending Hanging Signs

Catena metallica / Coil Chain

Cod.
Item-No.

Rotolo
Roll

PKR-KK

30 metri / meters



- Catena metallica per la sospensione delle cornici

- Metal Chain for use with S-Hooks to suspend Hanging Signs

Clip da soffitto / Ceiling Clip

Cod.
Item-No.

Confezione
Pack

10 pezzi / pieces

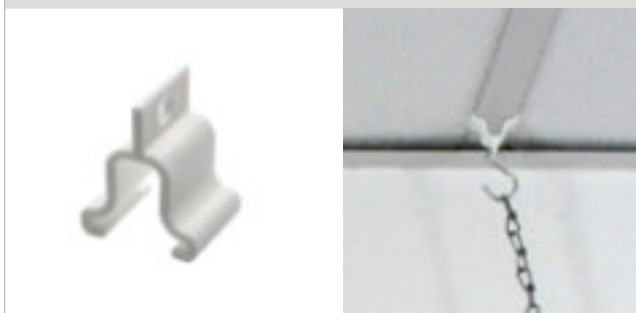

- Clip da soffitto in plastica bianca con occhio da 4 mm da agganciare ai canali metallici del controsoffitto
- Da utilizzare con catena metallica e Aggancio ad S

- White plastic Ceiling Clip with 4 mm eyelet for use with S-Hooks and Chain to suspend Hanging Signs from suspended ceiling metal channels

Sistema a sospensione 5S

5S-Suspension

Il metodo 5S contribuisce alla progettazione di processi di lavoro fluidi grazie al rispetto delle normative. La sospensione 5S costituita da tubi in acciaio, etichetta informativa e clip di collegamento, facilita l'implementazione del metodo 5S e fornisce un ambiente di lavoro pulito e ordinato.

The 5S method contributes to the design of smooth work processes due to the adherence to regulations. The 5S suspension, consisting of steel tubes, information label and connecting clips, facilitates the adherence to 5S methods and provides a clean and tidy work environment.





Sistema a sospensione 5S / 5S-Suspension

Cod.
Item-No.

PKR-5S

Composto da:

- 1 PKR-R28 (Tubo in acciaio L = 2420 mm, grigio)
- 3 PKR-A3-100 (bianco) incl. plastica trasparente e clip
- 3 PKR-A4-100 (giallo, verde, rosso) incl. plastica trasparente e clip
- 6 PKR-CL-RK-100
- 6 PKR-CL-OED-100
- 6 PKR-CL-HK-100
- 2 Tappi terminali per tubo, neri
- Catena non inclusa

Composed of:

- 1 PKR-R28 (Steel Tube 2420 mm, silver grey)
- 3 PKR-A3-100 (white) incl. Inlet and Clip
- 3 PKR-A4-100 (yellow, green, red) incl. Inlet and Clip
- 6 PKR-CL-RK-100
- 6 PKR-CL-OED-100
- 6 PKR-CL-HK-100
- 2 Tube End Caps, black
- Chain not included

Tabelle informative in alluminio

Aluminium Snap Frames

Tabelle informative in alluminio con plastica protettiva antiriflesso e sistema di chiusura a scatto, per un rapido e facile cambio di informazioni.

- 4 fori per il montaggio a muro
- Cornice esterna in alluminio L = 32 mm
- Disponibile in versione magnetica e scrivibile

Hinged sides provide for quick and easy change of documents. The aluminium snap frames are available in 5 DIN formats and documents can be changed quickly and easily.

- *Anti-reflective coating*
- *Invisible holes for wall mounting*
- *Long-lasting clamping effect*





Tabelle informative in alluminio / Aluminium Snap Frames

Cod. <i>Item-No.</i>	Formato DIN <i>DIN formats</i>	Dimensione (HxL) (mm) <i>Dim. (HxW) (mm)</i>
KN-ALU-A4	DIN A4	343 x 255
KN-ALU-A3	DIN A3	463 x 340
KN-ALU-A2	DIN A2	637 x 463
KN-ALU-A1	DIN A1	884 x 637
KN-ALU-A0	DIN A0	1234 x 882

Tabelle informative in alluminio magnetiche scrivibili / Writable magnetic aluminium Snap Frames

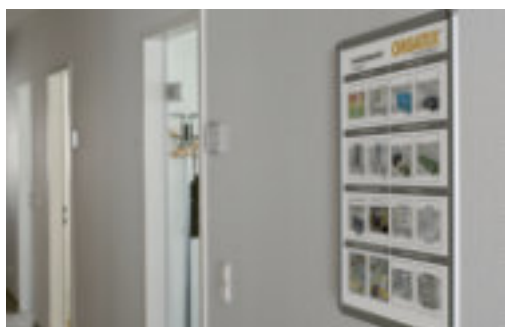
Cod. <i>Item-No.</i>	Formato DIN <i>DIN formats</i>	Dimensione (HxL) (mm) <i>Dim. (HxW) (mm)</i>
KN-ALU-A4-CL	DIN A4	343 x 255
KN-ALU-A3-CL	DIN A3	463 x 340
KN-ALU-A2-CL	DIN A2	637 x 463
KN-ALU-A1-CL	DIN A1	884 x 637
KN-ALU-A0-CL	DIN A0	1234 x 882

Sistema Kanban

Kanban Systems

Disponibilità di
materiale ottimizzata e
riduzione delle scorte:
con KANBAN il
controllo della
produzione è nelle tue
mani

KANBAN è un sistema per ottimizzare i processi di produzione, una logistica moderna e snella non può farne a meno. Si basa sul principio pull in cui i materiali vengono prodotti o consegnati seguendo le richieste della produzione. In pratica questo viene implementato con l'aiuto di schede KANBAN che funzionano secondo il "principio del semaforo": le schede KANBAN prelevate dai contenitori svuotati vengono inserite nella lavagna KANBAN in base al tipo. Se viene raggiunta la zona gialla il responsabile può decidere se produrre di più. Se viene raggiunta la zona rossa nuovo materiale deve essere prodotto o reintegrato immediatamente. Leanproducts srl vi fornisce tutti gli strumenti necessari per il controllo della produzione tramite KANBAN. Il nostro portafoglio comprende tutti i singoli elementi con una gamma completa di accessori per le vostre esigenze specifiche, nonché lavagne KANBAN in varie dimensioni e design, con le quali potete iniziare subito. Naturalmente, possiamo anche produrre sistemi KANBAN

o KANBAN Lot-Size su misura per le esigenze della tua azienda. Un altro metodo nel contesto della Lean Production è Heijunka (dal giapponese per "livellamento" o "lisciare"). Un pannello Heijunka consente di rendere la produzione più uniforme e anche di rispondere alle fluttuazioni o alle caratteristiche speciali della domanda. Possiamo creare questi sistemi organizzativi su misura per le vostre esigenze.

*Optimized material availability
and inventory reduction:
With KANBAN all the cards for
production control are in your
hand*

KANBAN is a method for optimizing manufacturing processes that modern, lean logistics can no longer do without. It is based on the pull principle, in which materials are produced as required or delivered to production. In practice, this is implemented with the help of KANBAN boards that work according to the "traffic light principle": KANBAN cards from emptied containers are inserted into the KANBAN board according to type by part number. If the yellow area is reached, the person responsible can decide whether to produce more. If the red area is reached, new material has to be produced or replenished immediately.

We provide you with all the aids necessary for production control via KANBAN. Our portfolio includes all individual elements with a comprehensive range of accessories for your specific needs as well as KANBAN starter sets in various sizes and designs, with which you can get started straight away. Of course, we can also manufacture an individual KANBAN

or Lot-Size KANBAN board for you, which is precisely tailored to the needs of your company. Another method in the context of Lean Production is Heijunka (from Japanese for „leveling“ or „smoothing“). A Heijunka board makes it possible to make production more uniform and also to respond to fluctuation or special features in demand. We create these organizational systems individually and tailored to and tailored to your needs.



Systembox

Systembox



Cassette posta KANBAN

KANBAN - Letterbox



Systembox A4

Systembox A4



Cardplan

Cardplan

Sistema Kanban

Infographic Inserting Systems

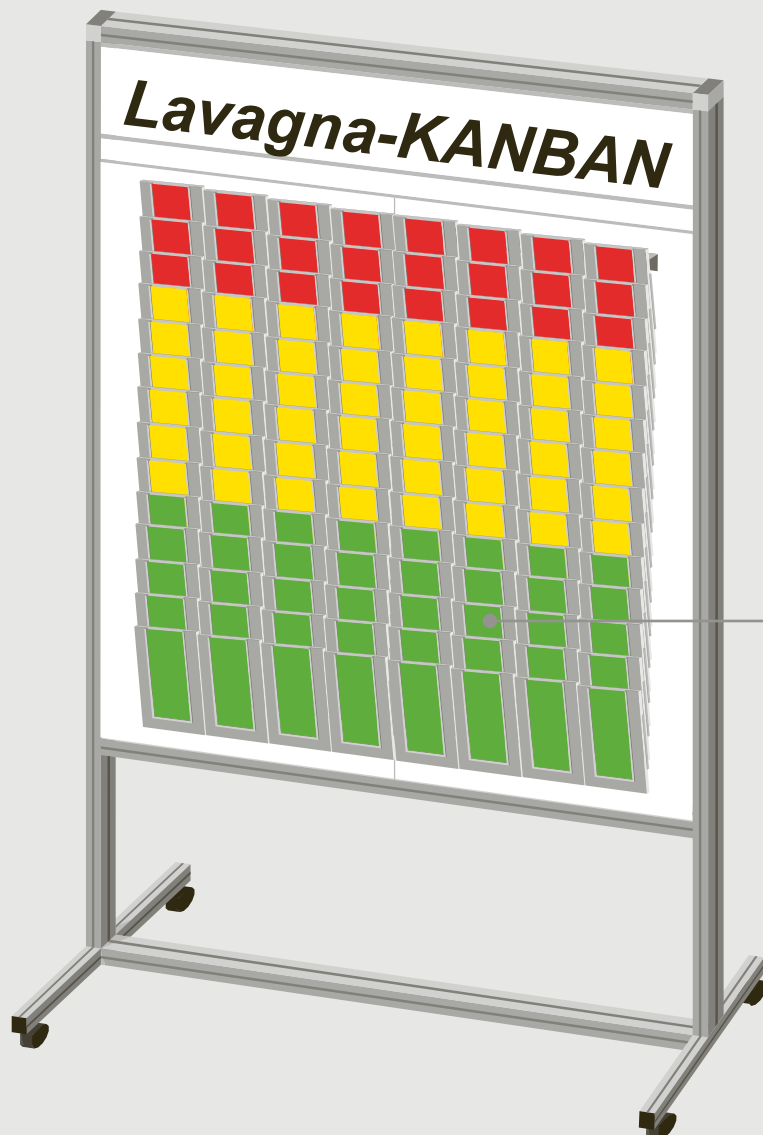

*Lavagna KANBAN con
organizzazione a semaforo
(con Systembox)
Traffic light KANBAN-Board
(with Systemboxes)*



Semplice
installazione
*Simple and quick
installation*

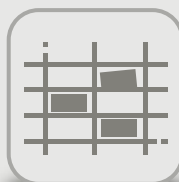

Cartellini KANBAN e
lavagne KANBAN offrono
la giusta soluzione
*KANBAN card to the KANBAN
board. We offer the right solution*



Progettato sulle
vostre specifiche
produttive
*Tailored to the needs
of your production*

ORGATEX®

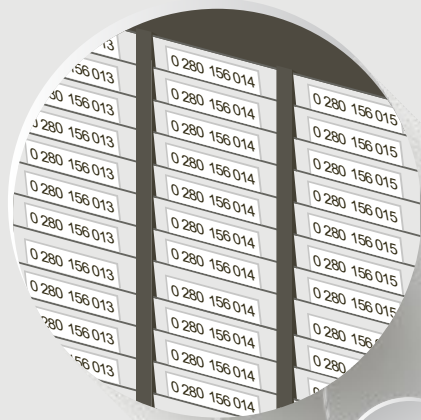

Cardplan

La modularità del sistema Cardplan permette la realizzazione di soluzioni veloci e robuste per la disposizione dei cartellini Kanban. Le tasche di inserimento permettono il posizionamento di cartoncini fino a 2 mm di spessore. I Cardplan possono essere affiancati.

Cardplan boards

Consisting of stacked rack elements. The rack elements are designed to secure both individual inserts and small stacks of inserts (up to 2 mm in thickness). The boards can be combined or expanded to any width.



Soluzioni personalizzate

Soluzioni create sulle esigenze del cliente.

Individual Solutions

Creation according to your individual requirements.

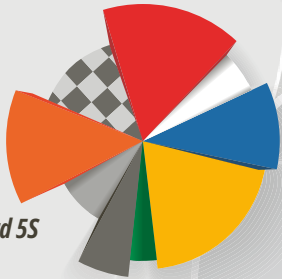

Colori standard 5S
Standard 5S
colors

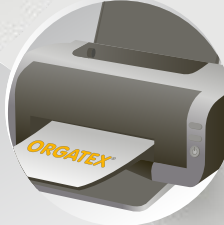

Cartoncini

Stampabili e acquistabili pretagliati.

Printing (cardboards)

Print out on standard paper or our pre-cut cardboards.

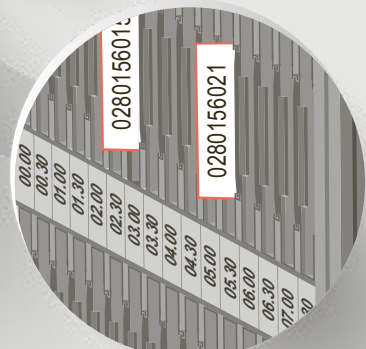

In continuo sviluppo

Continuous further development

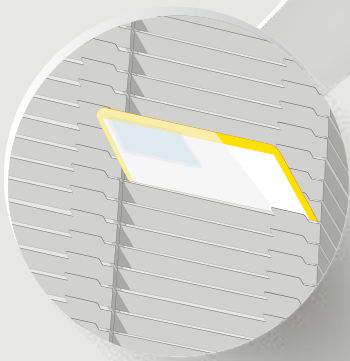

Sistema KANBAN

Decidi l'altezza e la larghezza desiderate. Espandi o raggruppa, forma linee di scomparti, appendi singoli scomparti, ecc. In caso di ampliamento, è sufficiente estrarre la piastra terminale e fissare ulteriori elementi di espansione o disporli nel punto desiderato. Tutti gli elementi possono essere raggruppati, espansi o divisi verticalmente o orizzontalmente in qualsiasi momento.

Primus viewing systems

Compile the desired height and width. Expand or regroup, e.g. form compartment lines, hang up individual compartments, etc. In the case of expansion, simply pull out the end plate and attach further expansion elements or arrange them at the required point. All elements can be regrouped, expanded or divided vertically or horizontally at any time.

Heijunka

Ogni pannello Heijunka viene creato in base alle esigenze individuali. In termini di altezza, larghezza e singoli elementi, è su misura per te e per le esigenze della tua produzione.

Heijunka Board

With the help of a Heijunka board, the quantity to be produced can be brought into a sequence / time grid and thus leveled. Each Heijunka board is created according to your individual requirements. In terms of height, width and the individual elements, it is tailored to you and the needs of your production.

Lavagna Lot-Size KANBAN

Lot-Size KANBAN

La produzione di lotti piccoli (idealmente un pezzo) è un fattore importante di molte strategie della Produzione Snella (Lean Manufacturing). La grandezza del lotto ha effetto diretto sull'inventario, sulla pianificazione nonché sui costi degli stessi. Altri effetti sono meno ovvi ma ugualmente importanti. I lotti piccoli riducono la variabilità nel sistema e livellano la produzione, migliorandone anche la qualità. Gli effetti di lotti piccoli differiscono tra Make to Order (MTO) e Make to Stock (MTS), ma sono importanti in entrambe le situazioni. Negli ambienti di MTO, la capacità di fare i lotti più piccoli rende economicamente pratico accettare ordini più piccoli. Questo può aprire nuovi segmenti di mercato o eliminare degli intermediari nella catena logistica. In un ambiente di MTS i lotti piccoli si traducono direttamente in inventari più piccoli. I costi di trasporto e di inventario vengono significativamente ridotti. I lotti piccoli permettono spesso la conversione da MTS a MTO.

With the lot-size KANBAN board, materials can be controlled according to the pull principle. Previously defined quantities are replenished according to type, resulting in a reduction of material stock and a levelling of production. Our control boards are built individually according to customers' requests and adapted to the existing requirements.



Heijunka

Heijunka Board

Heijunka: livellamento di produzione che equilibra il carico di lavoro all'interno della cella produttiva minimizzando, inoltre, le fluttuazioni di fornitura. Gli elementi principali della produzione Heijunka sono: il livellamento del volume di produzione e il livellamento del mix di produzione. Il "volume di produzione livellato" è dato dalla distribuzione uniforme della produzione in un dato periodo di tempo. Il volume di produzione livellato dipende dalla "varietà di produzione livellata", che è la distribuzione uniforme del mix / varietà di produzione in un dato periodo di tempo.

Due to fluctuations in demand, the processes in the upstream work stages involve increasingly large order peaks.

By means of the Heijunka Board, the customer or internal production orders are produced in a fixed (e.g., supply optimized) sequence and the fluctuations are leveled out and smoothened. Very often, this is the basis for creating stable processes.



Starter Kit KANBAN

KANBAN Starter set

Lo Starter Kit Kanban è un importante punto di partenza per l'implementazione dell'utilizzo del sistema Kanban e il principio della trasparenza della Lean Production.

- Struttura in profilato di alluminio 30 x 30 mm
- Ruote girevoli Ø 50 mm con freno
- Systembox
- Finestre magnetiche

Kanban boards are an important starting point for implementing the use of the Kanban system and the transparency principle of Lean Production.

- Structure in aluminum profile 30 x 30 mm
- Swivel wheels Ø 50 mm with brake
- Systembox
- Magnetic windows

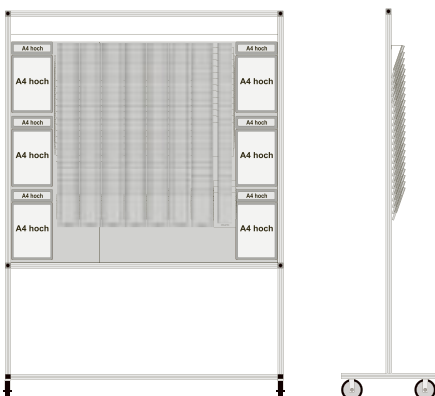

KANBAN Starter kit

KANBAN Starter sets Versions

Starter kit color / Color starter set

Cod. Kit Item-No.	305-36220731-1	Quantità Quantity	Cod. Item-No.
	Lavagna centrale L=2000 mm / Central board L = 2000 mm	1	B1-2000
	Systembox rossi / Red Systembox	1	SYSB-01
	Systembox gialli / Yellow Systembox	1	SYSB-04
	Systembox verdi / Green Systembox	2	SYSB-05
	Plastica superiore / Small label holder	4	SYSB-HE-35
	Plastica frontale / Large label holder	1	SYSB-HE-169
	Supporto per 4 Systembox / Systembox Wall Mount - 4 Rows	2	SYSB-WH-4
	Cassetta posta Kanban magnetica / Magnetic KANBAN Card Collection Mailbox	1	KNSERM116
	Finestra magnetica blu / Blue magnetic window	1	KAN-MW-A4H-03
	Cartoncini bianchi per plastica sup. / White small cardboard label	2	ET33-75K-02
	Cartoncini bianchi per plastica frontale / White large cardboard label	1	ET75-168K-02
	Kit 3 viti di fissaggio / Set 3 screws	2	305-36220131

Starter kit grigio / Grey starter set

Cod. Kit Item-No.	305-36220732-1	Quantità Quantity	Cod. Item-No.
	Lavagna centrale L=2000 mm / Central board L = 2000 mm	1	B1-2000
	Systembox grigi / Grey Systembox	1	SYSB-07
	Plastica superiore / Small label holder	4	SYSB-HE-35
	Plastica frontale / Large label holder	1	SYSB-HE-169
	Supporto per 4 Systembox / Systembox Wall Mount - 4 Rows	2	SYSB-WH-4
	Cassetta posta Kanban magnetica / Magnetic KANBAN Card Collection Mailbox	1	KNSERM116
	Finestra magnetica blu / Blue magnetic window	1	KAN-MW-A4H-03
	Cartoncini rossi per plastica superiore / Red small cardboard label	1	ET75-75K-01
	Cartoncini gialli per plastica superiore / Yellow small cardboard label	1	ET75-75K-04
	Cartoncini verdi per plastica superiore / Green small cardboard label	2	ET75-75K-05
	Cartoncini verdi per plastica frontale / Green large cardboard label	1	ET75-168K-05
	Kit 3 viti di fissaggio / Set 3 screws	2	305-36220131

KANBAN Systembox

KANBAN Systembox

I Systembox sono elementi plastici colorati che si possono incolonnare ed affiancare ad incastro. Utilizzati per la raccolta dei cartellini Kanban e la creazione di Sistemi Semaforo Kanban, Heijunka e Lot Size Kanban. La scanalatura dentellata posteriore è l'alloggiamento di un adattatore che permette l'inserimento di Kanban anche di piccole dimensioni.

Visual Pocket Systems with secure insertion of KANBAN cards, label pockets or other documents.

The patented connection system allows for joining of systeboxes as well as combining them side by side.





Systembox / Systembox			
Dimensione (LxHxP) (mm) Dimension (WxHxD) (mm)	Cod. Item-No.	+ Colore + Color	Confezione Pack
118 x 190 x 6	SYSB-	01 02 03 04 05 06 07 08 20	50 pezzi / pieces

Disponibile versione ESD a pag. 259
ESD version available at pag. 259

Accessori systembox

Systembox Accessories

Supporto verticale / Wall Mount (Stainless Steel)



Cod. Item-No.	Descrizione Description	Dimensione (LxH) (mm) Dimension (WxH) (mm)
------------------	----------------------------	---

SYSB-WH-1	Supporto verticale 1 colonna (2 fori di sostegno) / Wall Mount 1 Row (Stainless Steel)	111 x 166
------------------	--	-----------

SYSB-WH-4	Supporto verticale 4 colonne (3 fori di sostegno) / Wall Mount 4 Row (Stainless Steel)	486 x 166
------------------	--	-----------

- Dotato di fori per il montaggio a parete
- Materiale: acciaio

- Wall Mounts have holes for wall mounting or mounting on our Greyboards
- The Systemboxes are attached to the Wall Mount in 1 or 4 rows.
- Incl. mounting material

Supporto inferiore per muro / Wall Bracket (Stainless Steel)



Cod. Item-No.

SYSB-WH-U

- Il supporto inferiore per muro rende più stabile la colonna di Systembox
- Materiale: acciaio
- Viti escluse

- With this Wall Bracket, the Systembox before last can be fixed to the wall

Adattatore per Systembox / Adjustable Bottom

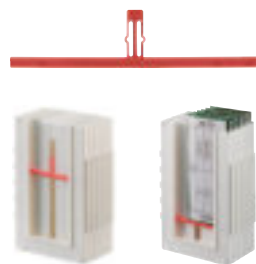

Cod. Item-No.

SYSB-FH

- Permette l'impiego di Kanban di piccole dimensioni limitando la profondità con regolazioni di 5 mm per volta.

Confezione Pack

50 pezzi / pieces

- Adjustable in 5 mm increments
- The Systembox can be adjusted to individual KANBAN card sizes

Plastica Systembox superiore / Small Label Holder



Cod. Item-No.

SYSB-HE-35

- Plastica superiore a chiusura della luce tra 2 Systembox in cascata

Cartoncini Cardboards

ET33-75K-Col.

Confezione Pack

50 pezzi / pieces

- Upper plastic to close the light between 2 Systemboxes in cascade

Disponibile versione ESD a pag. 259
ESD version available at pag. 259

Plastica Systembox bandiera / *Label Holder for Back Edge*

	Cod. <i>Item-No.</i>	Confezione <i>Pack</i>
	SYSB-RS-120	50 pezzi / <i>pieces</i>
	- Plastica a bandiera: ideale per Systembox in soluzione compatta	- <i>Plastic flag: ideal for Systembox in compact solution</i>

Simbolo di divieto / *Block Label*

	Cod. <i>Item-No.</i>	Confezione <i>Pack</i>
	SYSB-HE-35-SPERR	50 pezzi / <i>pieces</i>
	- Plastica a L che impedisce l'inserimento dei cartellini Kanban nel Systembox	- <i>L shaped plastic that prevents Kanban cards from being inserted into the Systembox</i>

Plastica Systembox frontale / *Large Label Holder*

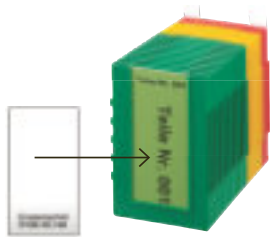
	Cod. <i>Item-No.</i>	Cartoncino <i>Cardboards</i>	Confezione <i>Pack</i>
	SYSB-HE-169	ET75-168K-Col.	50 pezzi / <i>pieces</i>
	- Plastica frontale a chiusura dell'ultimo Systembox in cascata	- <i>Front plastic to close the last Systembox in the cascade</i>	

Disponibile versione ESD a pag. 259
ESD version available at pag. 259

Cartoncini per plastiche superiori e frontali / *Cardboard Labels*

	Cod. <i>Item-No.</i>	+ Colore <i>+ Color</i>	Adatte a <i>Suitable for</i>	Cartoncini / Foglio <i>Cardboards / Pack</i>	Fogli DIN A4 <i>Sheets DIN A4</i>
	ET33-75K-	01 02 04 05	SYSB-HE-35	160	10
	ET75-168K-	01 02 04 05	SYSB-HE-169	30	10

Systembox A4

Systembox DIN A4

Disponibili in 2 colori e in 2 spessori per permettere anche la raccolta di molti fogli. Medesime caratteristiche di utilizzo dei Systembox standard e, con loro, perfettamente compatibili.

- Facilmente espandibile
- Disponibile con una profondità di 6 o 18 mm
- Compatibile con tutti i Systembox

Information viewing system for DIN A4 Documents.

Available in two versions, depending on the number of documents.

- Easily expandable
- Available with an inside depth of either 6 mm or 18 mm
- Compatible with all Systemboxes

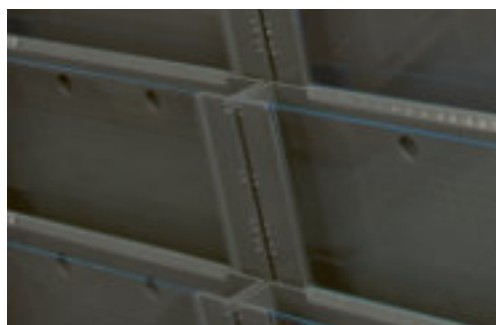

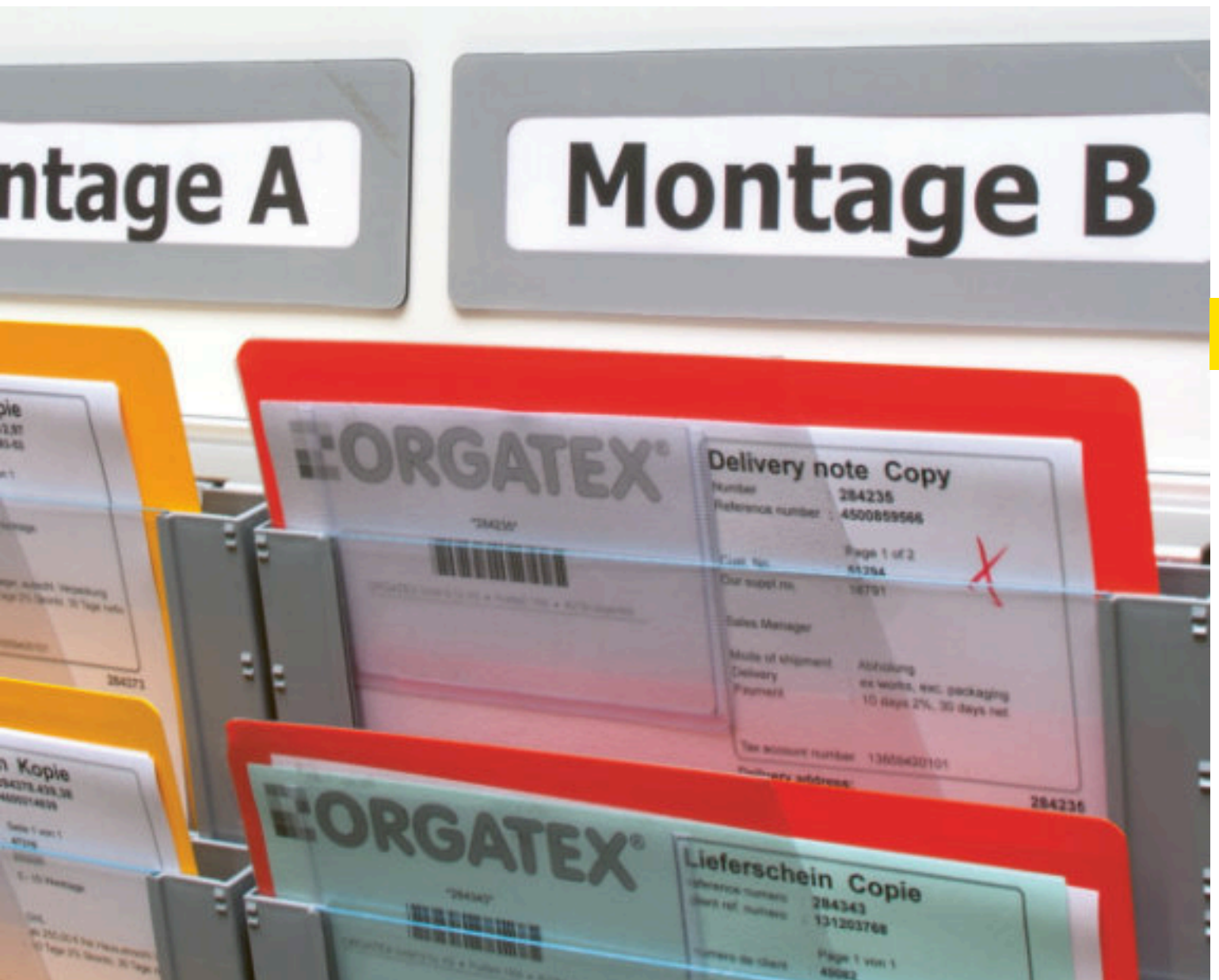
ORGATEX®

Systembox A4 standard / Systembox DIN A4 standard

Dimensione (LxHxP) (mm) Dimension (WxHxD) (mm)	Profondità (mm) Depth (mm)	Cod. Item-No.	+ Colore + Color ■ 5%	Confezione Pack
242 x 262 x 6	6	SYSB-A4S-	07 20	10 pezzi / pieces

Systembox A4 doppio / Systembox DIN A4 double

Dimensione (LxHxP) (mm) Dimension (WxHxD) (mm)	Profondità (mm) Depth (mm)	Cod. Item-No.	+ Colore + Color ■ 5%	Confezione Pack
242 x 262 x 18	18	SYSB-A4B-	07 20	10 pezzi / pieces

Accessori systembox A4

Systembox DIN A4 Accessories

Supporto verticale / Wall Mount DIN A4 (Stainless Steel)

	Cod. Item-No.	Dimensione (LxH) (mm) Dimension (WxH) (mm)
	SYSB-A4-WH-1	230 x 175
	<ul style="list-style-type: none"> - Dotato di fori per il montaggio a parete - Materiale: acciaio 	<ul style="list-style-type: none"> - Wall Mounts have holes for wall mounting or mounting on our Greyboards - The system boxes are placed in rows of 1 onto the wall bracket - Incl. mounting material

Supporto inferiore a muro per SYSB-A4S / Wall Bracket for Systembox small (Stainless Steel)

	Cod. Item-No.	
	SYSB-A4S-WH-U	
	<ul style="list-style-type: none"> -Dotato di fori per il montaggio a parete -Materiale: acciaio 	<ul style="list-style-type: none"> - With this Wall Bracket, the Systembox before last can be fixed to the wall

Supporto inferiore a muro per SYSB-A4B / Wall Bracket for Systembox large (Stainless Steel)

	Cod. Item-No.	
	SYSB-A4B-WH-U	
	<ul style="list-style-type: none"> -Dotato di fori per il montaggio a parete -Materiale: acciaio 	<ul style="list-style-type: none"> - With this Wall Bracket, the Systembox before last can be fixed to the wall

ORGATEX®Plastica Systembox superiore / *Small Transparent Cover DIN A4 small*

	Cod. <i>Item-No.</i>	Dimensione (LxH) (mm) <i>Dimension (WxH) (mm)</i>	Confezione <i>Pack</i>
	SYSB-A4-HE-90	200 x 90	10 pezzi / <i>pieces</i>

Plastica Systembox frontale / *Large Transparent Cover DIN A4 large*

	Cod. <i>Item-No.</i>	Dimensione (LxH) (mm) <i>Dimension (WxH) (mm)</i>	Confezione <i>Pack</i>
	SYSB-A4-HE-242	200 x 242	10 pezzi / <i>pieces</i>

Cardplan

Cardplan Boards

La modularità del sistema Cardplan permette la realizzazione di soluzioni veloci e robuste per la disposizione di documenti.

Le tasche di inserimento in plastica permettono un posizionamento preciso di cartoncini fino a 2 mm di spessore. È possibile inserire documenti con dimensioni da DIN A8 a DIN A4 con una parte visibile da 15 a 90 mm.

Cardplan panels are made of robust, torsion-free metal.

The insert cells are made of light grey, durable plastic.

They are designed to secure single documents as well as small document stacks (up to 2 mm). Documents can be inserted and taken out by hand. The frameless panels (except for DIN A4 portrait and landscape format) can be assembled in the required width and allow for later expansion.



Tasca	Tasca	Insert cell	Insert cell
Tasca	Tasca	Insert cell	Insert cell
Tasca	Tasca	Insert cell	Insert cell
Tasca	Tasca	Insert cell	Insert cell
Tasca	Tasca	Insert cell	Insert cell
Tasca	Tasca	Insert cell	Insert cell
Tasca	Tasca	Insert cell	Insert cell
Bordo visibile	Bordo visibile	Visible edge	Visible edge
↑ Profondità di inserimento ↓	↑ Profondità di inserimento ↓	↑ Insertion depth ↓	↑ Insertion depth ↓

Il bordo visibile è la parte emergente del cartoncino. La profondità di inserimento corrisponde alla porzione di cartoncino che resta nascosta.

The visible edge is the part of an inserted document, which can be seen above the insert cell. The part of the document, covered by the insert cell is called insertion depth.

Visibile
Visible
Nascosto
Hide

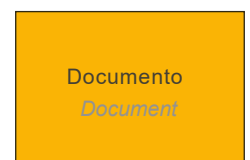

Altezza documento
Document height



Cardplan

Cardplan Boards

Cardplan <i>Cardplan Boards</i>	Bordo visibile <i>Visible Edge</i>	Altezza pannello <i>Panel height</i>	Righe <i>Rows</i>	Cod. / Larghezza 250 mm <i>Item-No. / Width 250 mm</i>	Cod. / Larghezza 500 mm <i>Item-No. / Width 500 mm</i>	
Altezza cartoncino 74 mm <i>Document Height 74 mm</i>	20 mm	440 mm	17	K217-20-G	K517-20-G	
	20 mm	795 mm	34	K227-20-G	K527-20-G	
DIN A7 orizz. / DIN A8 vert. <i>DIN A7 landsc. / DIN A8 portr.</i>	20 mm	1085 mm	51	K237-20-G	K537-20-G	
	20 mm	1244 mm	59	K247-20-G	K547-20-G	
	30 mm	440 mm	11	K217-30-G	K517-30-G	
	30 mm	795 mm	23	K227-30-G	K527-30-G	
	30 mm	1085 mm	33	K237-30-G	K537-30-G	
	30 mm	1244 mm	39	K247-30-G	K547-30-G	
	Altezza cartoncino 100 mm <i>Document Height 100 mm</i>	30 mm	440 mm	11	K212-30-G	K512-30-G
		30 mm	795 mm	23	K222-30-G	K522-30-G
30 mm		1085 mm	33	K232-30-G	K532-30-G	
30 mm		1244 mm	38	K242-30-G	K542-30-G	
Altezza cartoncino 105 mm <i>Document Height 105 mm</i>	20 mm	440 mm	16	K216-20-G	K516-20-G	
	20 mm	795 mm	34	K226-20-G	K526-20-G	
DIN A6 orizz. / DIN A7 vert. <i>DIN A6 landsc. / DIN A7 portr.</i>	20 mm	1085 mm	50	K236-20-G	K536-20-G	
	20 mm	1244 mm	56	K246-20-G	K546-20-G	
Altezza cartoncino 148 mm <i>Document Height 148 mm</i>	20 mm	440 mm	14	K215-20-G	K515-20-G	
	20 mm	795 mm	32	K225-20-G	K525-20-G	
	20 mm	1085 mm	46	K235-20-G	K535-20-G	
	20 mm	1244 mm	53	K245-20-G	K545-20-G	
	30 mm	440 mm	10	K215-30-G	K515-30-G	
	30 mm	795 mm	21	K225-30-G	K525-30-G	
	30 mm	1085 mm	31	K235-30-G	K535-30-G	
	30 mm	1244 mm	36	K245-30-G	K545-30-G	
	40 mm	440 mm	7	K216-40-G	K516-40-G	
	40 mm	795 mm	16	K226-40-G	K526-40-G	
	40 mm	1085 mm	23	K236-40-G	K536-40-G	
	40 mm	1244 mm	28	K246-40-G	K546-40-G	
	60 mm	440 mm	5	K216-60-G	K516-60-G	
	60 mm	795 mm	11	K226-60-G	K526-60-G	
	60 mm	1085 mm	16	K236-60-G	K536-60-G	
	60 mm	1244 mm	19	K246-60-G	K546-60-G	

Cardplan <i>Cardplan Boards</i>	Bordo visibile <i>Visible Edge</i>	Altezza pannello <i>Panel height</i>	Righe <i>Rows</i>	Cod. / Larghezza 250 mm <i>Item-No. / Width 250 mm</i>	Cod. / Larghezza 500 mm <i>Item-No. / Width 500 mm</i>
Altezza cartellino 210 mm <i>Document Height 210 mm</i>	15 mm	795 mm	36	K224-15-G*	K524-15-G
	15 mm	1085 mm	56	K234-15-G*	K534-15-G
DIN A4 orizz. / DIN A5 vert. <i>DIN A4 landsc. / DIN A5 portr.</i>	20 mm	440 mm	11	K214-20-G*	K514-20-G*
	20 mm	795 mm	29	K224-20-G*	K524-20-G*
*con sponde di contenimento in alluminio da entrambi i lati <i>*with aluminium frame on both sides.</i>	20 mm	1085 mm	43	K234-20-G*	K534-20-G*
	20 mm	1244 mm	49	K244-20-G*	K544-20-G*
	30 mm	440 mm	8	K214-30-G*	K514-30-G*
	30 mm	795 mm	19	K224-30-G*	K524-30-G*
	30 mm	1085 mm	29	K234-30-G*	K534-30-G*
	30 mm	1244 mm	35	K244-30-G*	K544-30-G*
	90 mm	440 mm	3	K215-90-G*	K515-90-G
	90 mm	795 mm	7	K225-90-G*	K525-90-G
	90 mm	1085 mm	10	K235-90-G*	K535-90-G
	90 mm	1244 mm	12	K245-90-G*	K545-90-G*
Altezza cartellino 297 mm <i>Document Height 297 mm</i>	30 mm	440 mm	5	K213-30-G*	K513-30-G*
	30 mm	795 mm	17	K223-30-G*	K523-30-G*
DIN A3 orizz. / DIN A4 vert. <i>DIN A3 landsc. / DIN A4 portr.</i>	30 mm	1085 mm	26	K233-30-G*	K533-30-G*
	30 mm	1244 mm	31	K243-30-G*	K543-30-G
*con sponde di contenimento in alluminio da entrambi i lati <i>*with aluminium frame on both sides.</i>	60 mm	440 mm	3	K213-60-G*	K513-60-G*
	60 mm	795 mm	9	K223-60-G*	K523-60-G*
	60 mm	1085 mm	13	K233-60-G*	K533-60-G*
	60 mm	1244 mm	16	K243-60-G*	K543-60-G*
	90 mm	440 mm	2	K213-90-G*	K513-90-G*
	90 mm	795 mm	6	K223-90-G*	K523-90-G*
	90 mm	1085 mm	9	K233-90-G*	K533-90-G*
	90 mm	1244 mm	10	K243-90-G*	K543-90-G*

Sponde di contenimento in alluminio per Cardplan (coppia) / Aluminium frame for Cardplan Board (pair)

	Dimensione (LxPxH) (mm) <i>Dimensions (L x W x H) (mm)</i>	Cod. <i>Item-No.</i>
	10 x 40 x 400	K-W400
	10 x 40 x 760	K-W760
	10 x 40 x 1060	K-W1060
	10 x 40 x 1220	K-W1220
	- con 3 fori per il fissaggio	- with 3 holes for fixing

Accessori Cardplan

Cardplan Accessories

Divisorio verticale / Vertical Dividers

	Lunghezza (mm) Length (mm)	Cod. Item-No.	Confezione Pack
	1020	KST1020	10 pezzi / pieces
	1220	KST1220	10 pezzi / pieces
<ul style="list-style-type: none"> - Adesivo - Permette di suddividere orizzontalmente in maniera visuale il Cardplan - KST1020 per carplan altezza 440, 795 e 1085 mm - KST1220 per carplan altezza 1244 mm 		<ul style="list-style-type: none"> - Adhesive - Allows you to visually divide the Cardplan horizontally - KST1020 for table heights 440 mm, 795 mm and 1085 mm. - KST1220 for table heights 1244 mm. 	

Divisorio orizzontale / Landscape Dividers

	Lunghezza (mm) Length (mm)	Cod. Item-No.	Confezione Pack
	250	KAN-AMPEL250-07	10 pezzi / pieces
	500	KAN-AMPEL500-07	10 pezzi / pieces
<ul style="list-style-type: none"> - Permette di suddividere orizzontalmente in maniera visuale il Cardplan - Colore : grigio - Può essere posizionato sopra le celle di inserzione 		<ul style="list-style-type: none"> - Allows you to visually divide the Cardplan horizontally - Color: grey - Can be placed over the insertion cell. 	

Porta etichette / Cardplan Label Holder

	Dimensione (LxH) (mm) Dimension (WxH) (mm)	Cod. Item-No.	Confezioni Pack
	75 x 15	KE75-15	10 pezzi / pieces
	75 x 20	KE75-20	10 pezzi / pieces
	210 x 20	KE210-20	10 pezzi / pieces
	75 x 30	KE75-30	10 pezzi / pieces
	210 x 30	KE210-30	10 pezzi / pieces
<p>Soluzione semplice per inserire etichette nella posizione che preferisci all'interno del Cardplan</p>			<p>Simply place your label in our Cardplan Label Holder and position any way you like.</p>

Sistema semaforo per Cardplan / Color Labels for Cardplan

	Lunghezza (mm) Length (mm)	Cod. Item-No.	+ Colore + Color	Confezione Pack
	75	KAN-AMPEL75-	01 04 05 07	10 pezzi / pieces
	85	KAN-AMPEL85-	01 04 05 07	10 pezzi / pieces
	120	KAN-AMPELA7-	01 04 05 07	10 pezzi / pieces
	155	KAN-AMPELA6-	01 04 05 07	10 pezzi / pieces
	215	KAN-AMPELA5-	01 04 05 07	10 pezzi / pieces
	250	KAN-AMPEL250-	01 04 05 07	10 pezzi / pieces
	500	KAN-AMPEL500-	01 04 05 07	10 pezzi / pieces

Supporto orizzontale a Z (coppia) / Z-Profile (pair)

	Lunghezza (mm) Length (mm)	Cod. Item-No.
	500	Z500
	750	Z750
	1000	Z1000
	<ul style="list-style-type: none"> - Fissaggio a muro - 1 elemento superiore e 1 elemento inferiore - Il profilo a Z è realizzato in alluminio di altissima qualità che consente un montaggio a parete robusto e affidabile. - Colore: grigio 	<ul style="list-style-type: none"> - Wall fixed - Set = Top and Bottom Rail - The Z-Profile is made of the highest quality aluminum allowing for sturdy, reliable wall mounting. - Color: grey

Supporto orizzontale (coppia) / Rails (pair)

	Lunghezza (mm) Length (mm)	Cod. Item-No.
	500	KR2203-50
	1290	KR2203-00
	<ul style="list-style-type: none"> - Fissaggio a muro - Giunzione per supporti orizzontali - 1 elemento superiore e 1 elemento inferiore 	<ul style="list-style-type: none"> Color: grey (anthracite) Rails, powder-coated, wall-mounted (not available for Planning Table Stand) Set = Top and Bottom Rail

Supporti magnetici (coppia) / Sheet with magnets (pair)

	Per lavagne di larghezza (mm) Usable for Board-width (mm)	Cod. Item-No.
	250 ¹	K2-BLM4
	500 ²	K5-BLM6
	<ul style="list-style-type: none"> Set = 2 pezzi, include viti e chiave a brugola, pronto per il montaggio ¹ 4 magneti Neodym ² 6 magneti Neodym Utilizzabile per pannelli fino ad un'altezza di 1085 mm Può essere utilizzato dalla data di produzione di agosto 2016 	<ul style="list-style-type: none"> Set = Top and Bottom Sheet, incl. screws and allen key, ready for mounting ¹ includes 4 neodymium magnets ² includes 6 neodymium magnets Usable up to panel height 1085 mm Can be used from production date august 2016

Cassette posta KANBAN trasparenti

KANBAN-Letterbox, transparent

Una maniera semplice per raccogliere i cartellini Kanban prima di disporli negli appositi contenitori. Prodotte in plastica trasparente con 2 fori per il fissaggio. Capienza 35 mm.

- Cassette posta KANBAN trasparente (KN-BK-35) per cartellini KANBAN secondo la normativa VDA4902
- Adatto per un massimo di 40 cartellini KANBAN
- Alta capacità in tutti i formati

The KANBAN Letterbox provides a secure storage for KANBAN cards and has a high storage capacity. The KANBAN Letterbox can be mounted on the wall or on a stand.

- KANBAN Letterbox transparent (KN-BK-35) for KANBAN cards according to VDA-norm 4902
- Suitable for up to 40 KANBAN cards
- High capacity in all formats





Cassette posta KANBAN in plastica trasparente / KANBAN-Letterbox trasparente

Descrizione <i>Description</i>	Cod. <i>Item-No.</i>	Dimensione (LxHxP) (mm) <i>Dim. (LxHxW) (mm)</i>	Confezione <i>Pack</i>
Trasparente / <i>Transparent</i>	KN-BK-35	115 x 165 x 35	2 pezzi / <i>pieces</i>
DIN A5 vert. trasparente / <i>Transparent DIN A5</i>	KN-BK-A5-35	165 x 165 x 35	2 pezzi / <i>pieces</i>
DIN A4 vert. trasparente / <i>Transparent DIN A4</i>	KN-BK-A4-35	230 x 250 x 35	1 pezzo / <i>piece</i>
DIN A5 orizz. trasparente / <i>Transparent DIN A5 landsc.</i>	KN-BK-A5Q-35	217 x 127 x 35	2 pezzi / <i>pieces</i>
Trasparente magnetico / <i>Transparent magnetic</i>	KN-BKM-35	115 x 165 x 35	2 pezzi / <i>pieces</i>
DIN A5 vert. trasparente magnetico / <i>Transparent magnetic DIN A5</i>	KN-BKM-A5-35	165 x 165 x 35	2 pezzi / <i>pieces</i>
DIN A4 vert. trasparente magnetico / <i>Transparent magnetic DIN A4</i>	KN-BKM-A4-35	230 x 250 x 35	1 pezzo / <i>piece</i>
DIN A5 orizz. trasparente magnetico / <i>Transparent magnetic DIN A5 landsc.</i>	KN-BKM-A5Q-35	217 x 127 x 35	2 pezzi / <i>pieces</i>

Disponibile versione ESD a pag. 259
ESD version available at pag. 259

Cassette posta Kanban

Primus View Box

Una maniera semplice per raccogliere i cartellini Kanban prima di disporli negli appositi contenitori. Prodotte in lamiera verniciata con 2 fori per il fissaggio. Disponibili con plastica frontale trasparente o grigia.

Tutti i moduli possono essere riorganizzati, suddivisi o espansi verticalmente o orizzontalmente.

Suitable for warehouse, workshop, production or offices areas. Height and width can be arranged as required. Expansion and rearrangement are possible at all times. You can arrange clusters according to subject matter or mount individual modules, etc. If expansion is required, remove the end cover plate and arrange expansion modules as required. All modules can be rearranged, subdivided or expanded vertically or horizontally. You can stabilize each column by including an extra angle at the bottom edge.

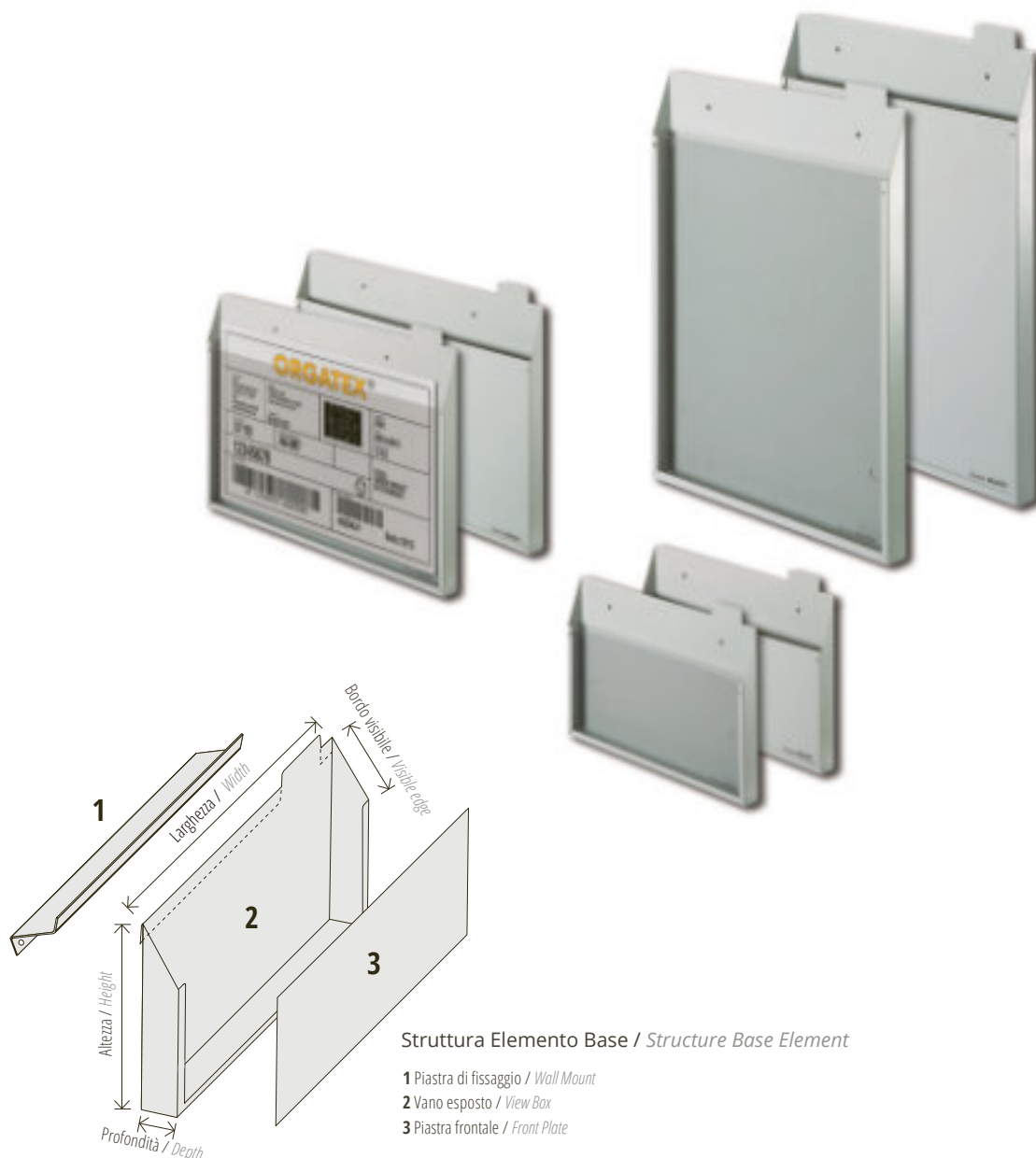

ORGATEX®



Altezza e larghezza personalizzabili. Espandi o riorganizza in qualsiasi momento definendo il numero di righe e colonne.

Semplicemente:

Installa il supporto a parete, collega un numero definito di cassette e chiudi l'ultima con la piastra frontale a scorrimento.

Per espandere:

Rimuovere la plastica frontale per aggiungere altre cassette.

Customizable height and width. Expand or rearrange at any time by defining the number of rows and columns.

Simply:

Install the wall bracket, connect a defined number of and close the last one with the sliding front plate.

For expansion:

Remove the front plastic to add more cassettes.

Cassette Kanban e accessori

Primus Column or Row System / Accessories

Elemento base cassetta Kanban con fronte grigio + estensione / Basic element set grey front plate

	Formato documenti <i>For DIN Document Format</i>	Dimensione (LxH) (mm) <i>Dimension (WxH) (mm)</i>	Cod. <i>Item-No.</i>	Estensione <i>Extension Element</i>
	DIN A4 orizz. / DIN A5vert. <i>DIN A4 landsc. / DIN A5 portr.</i>	337 x 210	SBAM103	SER113
	DIN A4 vert. <i>DIN A4 portr.</i>	250 x 300	SBAM104	SER114
	DIN A5 orizz. / DIN A6vert. <i>DIN A5 landsc. / DIN A6 portr.</i>	250 x 150	SBAM105	SER115
Elemento base completo con fronte grigio ed elemento estensione			<i>Basic element consisting of wall suspension, visible compartment element and grey front plate Extension element consisting of a visible compartment element</i>	

Elemento base cassetta Kanban con fronte trasparente + estensione / Basic element set transparent front plate

	Formato documenti <i>For DIN Document Format</i>	Dimensione (LxH) (mm) <i>Dimension (WxH) (mm)</i>	Cod. <i>Item-No.</i>	Estensione <i>Extension Element</i>
	DIN A4 orizz. / DIN A5vert. <i>DIN A4 landsc. / DIN A5 portr.</i>	337 x 210	SBAP103	SER113
	DIN A4 vert. <i>DIN A4 portr.</i>	250 x 300	SBAP104	SER114
	DIN A5 orizz. / DIN A6vert. <i>DIN A5 landsc. / DIN A6 portr.</i>	250 x 150	SBAP105	SER115
Elemento base completo con fronte trasparente ed elemento estensione			<i>Basic element consisting of wall suspension, visible compartment element and transparent front plate Extension element consisting of a visible compartment element</i>	

Accessorio / Accessorie

Descrizione <i>Description</i>	Cod. <i>Item-No.</i>
Staffa con angolo a Z per tutti i formati DIN / <i>Z-Angle Bracket for all DIN Formats</i>	SZW110

Cassette Kanban individuale

Individual Boxes

Cassetta Kanban fronte grigio / Individual box with grey front plate



Formato documento <i>For DIN Document Format</i>	Dimensione (LxH) (mm) <i>Dimension (WxH) (mm)</i>	Cod. <i>Item-No.</i>
DIN A4 orizz. / DIN A5 vert. <i>DIN A4 landsc. / DIN A5 portr.</i>	337 x 210	SERM113
DIN A4 vert. <i>DIN A4 portr.</i>	250 x 300	SERM114
DIN A5 orizz. / DIN A6 vert. <i>DIN A5 landsc. / DIN A6 portr.</i>	250 x 150	SERM115

Elemento base forato senza piastra di fissaggio a muro con fronte grigio

*Individual Shelf with pre-drilled holes for screws, and grey Front Plate
Not wall-mounted*

Cassetta Kanban fronte trasparente / Individual Box with transparent front plate



Formato documenti <i>For DIN Document Format</i>	Dimensione (LxH) (mm) <i>Dimension (WxH) (mm)</i>	Cod. <i>Item-No.</i>
DIN A4 orizz. / DIN A5 vert. <i>DIN A4 landsc. / DIN A5 portr.</i>	337 x 210	SERP113
DIN A4 vert. <i>DIN A4 portr.</i>	250 x 300	SERP114
DIN A5 orizz. / DIN A6 vert. <i>DIN A5 landsc. / DIN A6 portr.</i>	250 x 150	SERP115
1/3 DIN	250 x 100	SERP116

Elemento base forato senza piastra di fissaggio a muro con fronte trasparente

*Individual Shelf with pre-drilled holes for screws, and grey front plate
Not wall-mounted*

Cassetta posta Kanban magnetica fronte trasparente / KANBAN-Letterbox magnetic with Transparent Front Plate



Formato documenti <i>For DIN Document Format</i>	Dimensione (LxH) (mm) <i>Dimension (WxH) (mm)</i>	Cod. <i>Item-No.</i>
DIN A5 orizz. <i>DIN A5 landsc.</i>	250 x 150	KNSERM115
1/3 DIN	250 x 100	KNSERM116

- Estremamente resistenti e durature.
- Semplici da applicare grazie alle 2 strisce magnetiche poste sul retro della cassetta.
- Ampia capacità grazie al compartimento di 15 mm di profondità.

- *Light grey powder-coated steel, extremely resistant and long lasting.*
- *Simple mounting with magnetic back panel.*
- *Large capacity provided with compartment depth of 15 mm.*

Cartella porta documenti

Work document DIN A4

Cartelle portadocumenti DIN A4 verticale con porta biglietto da visita in alto a sinistra. Permette la lettura dei documenti senza doverli rimuovere.

- Scansionabile con lettore codice a barre

Work document pocket for DIN A4 sheets with transparent film welded on the back. Welded on business card pocket at the top left for notes or additional information.

- Scanner readable for QRcode / barcode.





Cartella portadocumenti / Work document pocket

Dimensione (LxH) (mm)
Dimension (WxH) (mm)

Cod.
Item-No.

+ Colore
+ Color

Confezione
Pack

230 x 314

STP420-

01 02 03 04 05 06 07 08

10 pezzi / pieces

Cartella Primus

Primus Workstation Envelope

Per raccogliere e proteggere documenti in DIN A4 verticale.
Possono essere appese singolarmente o inserite nelle cassette porta Kanban.

- 3 fori rinforzati con anelli
- Velcro di chiusura sul retro
- Capacità 7 mm

Primus Workstation Envelope for inserting and protecting work documents, drawings etc. Pockets can be mounted on elastic cords (incl. in delivery scope), reinforced eyelets or inserted into Primus ViewBoxes.

- 3 reinforced eyelets in header
- Velcro strap on the back
- Large document capacity, approx. 7 mm





Cartella Primus / Primus Workstation Envelope

Dimensione (LxH) (mm)
Dimension (LxH) (mm)

Cod.
Item-No.

Confezione
Pack

240 x 330

ATP420

10 pezzi / pieces

Sempre sotto controllo:
con le nostre lavagne
garantite la trasparenza
operativa

Lavagne ed accessori

Visual Boards

Le lavagne informative creano spazi dove scrivere, disegnare, pianificare, progettare, appuntare, cancellare e ricominciare.

Sono lo strumento perfetto per rappresentare e visualizzare i flussi di produzione, l'andamento della qualità e la gestione delle informazioni in un'ottica di miglioramento continuo.

A seconda dell'area di applicazione offriamo diverse varianti: le nostre lavagne a muro sono poco ingombranti e adatte all'affiancamento a macchine nel settore produttivo mentre le nostre lavagne informative con ruote offrono la massima flessibilità e possono anche essere dotate di mensole o portadocumenti. I Lean Cube in posizioni centrali consentono un migliore svolgimento di meeting e di riunioni di gruppo. Grazie alla loro forma possono essere utilizzati anche in luoghi che offrono poco spazio.

Una lavagna è tanto personalizzabile quante sono le richieste dell'azienda. Personalizzabili anche graficamente con il logo dell'azienda e / o intestazioni secondo le specifiche richieste oltre che con matrici o tabelle.

Nel caso tu stia cercando una soluzione completamente su misura possiamo progettare da zero il tuo modulo lavagna.

*Keeping an overview at all
times: with our Visual Boards
you ensure transparency in
operation*

The fast, easy and uncomplicated provision of information and key figures at central points in the company is an important part of a smooth operation. Visual Boards are the ideal tool for this, because with them you have a clear view of all important information at all times. Whether for mapping target and actual conditions, quality indicators or running times of machines - Visual Boards can perform a wide variety of functions.

Depending on the area of application, we offer different variants of boards: our wallboards are suitable for permanent use, e.g. can be easily attached near machines. Our rollable stand boards offer maximum flexibility and can also be provided with shelves or file holders. Rotatable cubes in central locations enable meetings and team meetings to run better. Due to their shape, they can also be used in places that offer little space. Stop signs serve as a clear indication and stopping place for your milk run. Our entire Visual

Board portfolio is also available as a white board version for labeling with board markers.

A Visual Board is as individual as the company in which it is used. We design the boards with your company logo and provide them with headings according to your specifications. We also print white boards individually for you with matrices or tables. And if you are looking for a completely tailor-made solution: our specialist department designs and produces your individual board for you.



Lavagne informative
Visual boards



Lavagne informative GF
Visual boards GF

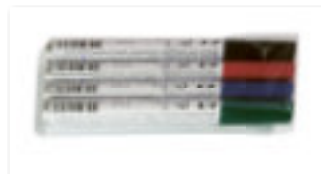

Accessori
Accessories

Lean factory corner

Infographic Visual Boards

Integrabile con dispositivi audiovisivi (Monitor, TV etc..)
Integration of audiovisual media (monitors, TVetc..)

Design del titolo personalizzabile (Logo e testo)
Individual heading design (logo and text)

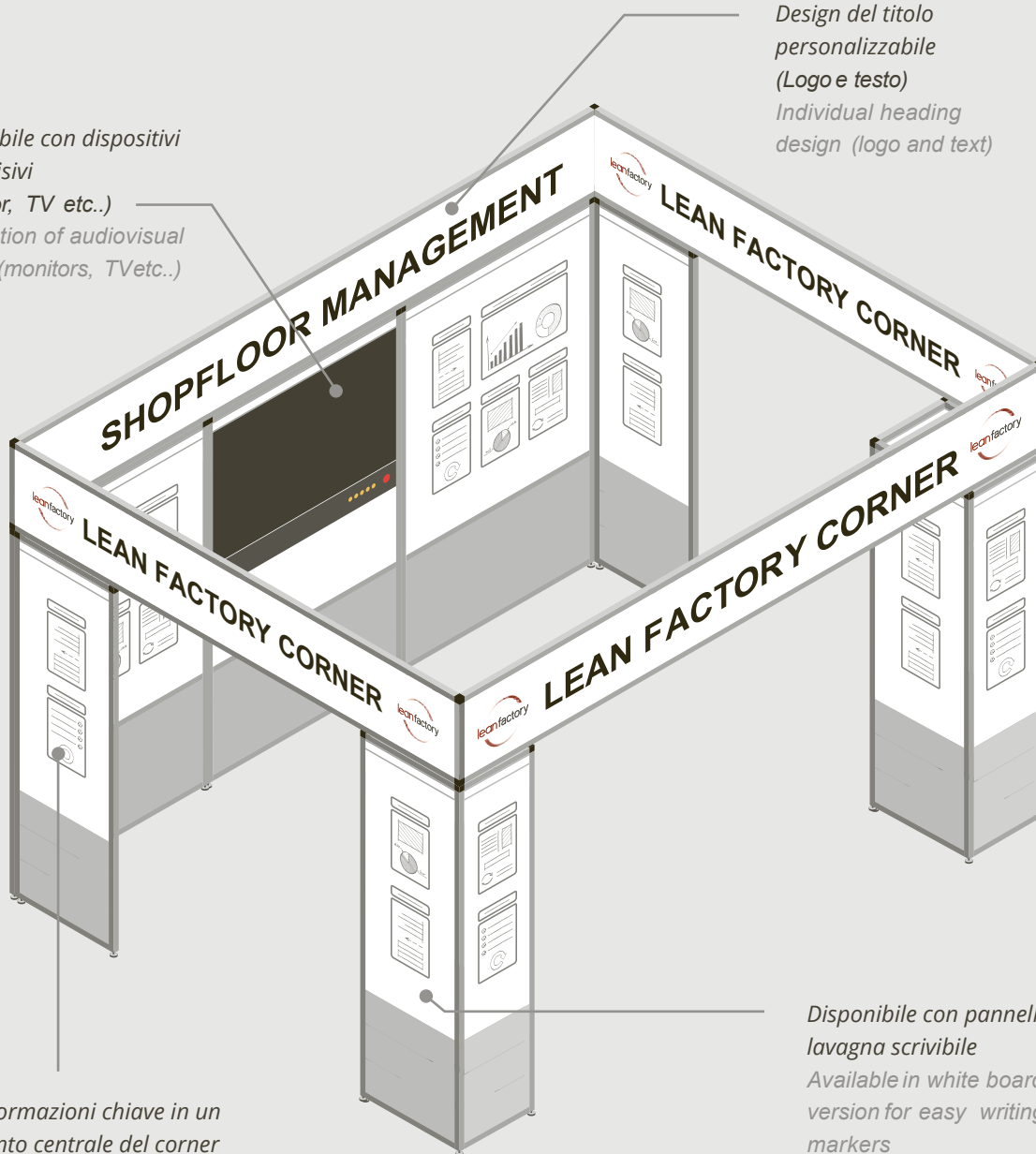

Informazioni chiave in un punto centrale del corner
Provision of key figures and information at a central point

Disponibile con pannello lavagna scrivibile
Available in white board version for easy writing with markers



Prodotti seguendo le tue specifiche
Production with in-house solutions according to your specifications



Fornitura di elementi chiave e informazioni
Provision of key figures and information



Disegnata sulle necessità della tua produzione
Tailored to the needs of your production

ORGATEX®

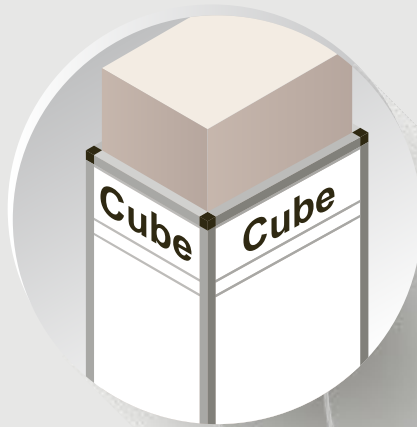

Lean Cube

Leggerezza e praticità per la massima resa funzionale ed estetica.

Cube

Lightness and practicality for maximum functional and aesthetic Performance.

Scrivibile

Scrivibili

Labelable

Writable



Integrazione multimediale

Il nostro profilo in alluminio permette di integrare nuovi accessori alla struttura della lavagna.

Media integration

You can integrate all media into our system (aluminum profiles).

Soluzioni personalizzabili
Individual Special solutions



Vasto range di accessori

Extensive range of accessories



Lavagne a muro

Le lavagne a muro vengono utilizzate ovunque ci siano opzioni di montaggio in loco, ad es. su pareti, alloggiamento della macchina e altre superfici installate in modo permanente.

Wallboard

Wallboards are used wherever there are mounting options on site, e.g. on walls, machine housing and other permanently installed surfaces.

Standboard

Offriamo diversi modelli di lavagne che vanno da quelle a muro fino a quelle su ruote in versioni standard per rispondere in modo attento e veloce ad ogni esigenza produttiva.

Stand-alone board

We offer different models of whiteboards ranging from wall-mounted to those on wheels in standard versions to respond quickly and attentively to every production requirement.

Lean Factory Corner

Lean Factory Corner



I pannelli dei nostri Lean Factory Corner hanno profili in alluminio e sono realizzati con superfici smaltate, vetrificate a 800° C in materiale ecologico. Questo speciale trattamento li rende inalterabili, resistenti ai raggi solari, al calore elevato ed ai prodotti chimici, scrivibili e cancellabili.

The panels of our Lean Factory Corners have aluminum profiles and are made with enamelled surfaces, vitrified at 800° C in ecological material. This special treatment makes them unalterable, resistant to sunlight, high heat and chemical products, writable and erasable.

Lean Factory Corner / *Lean Factory Corner*

Dimensione (LxHxP) (mm) Cod.
 Dimension (LxHxW) (mm) Item-No.

3604 x 2060 x 2500

303-36220603-2-B

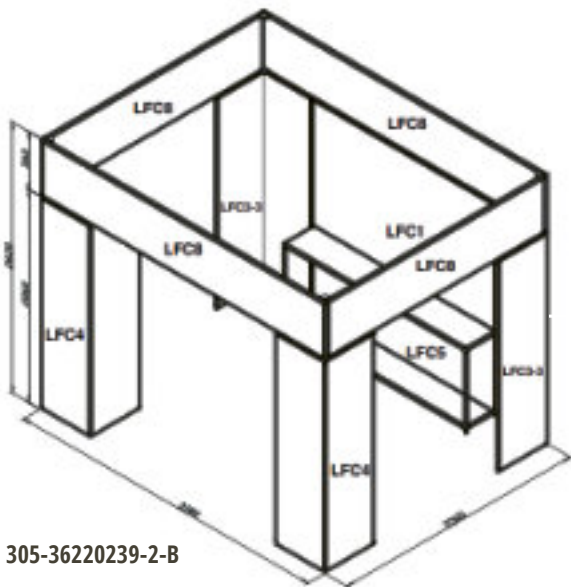
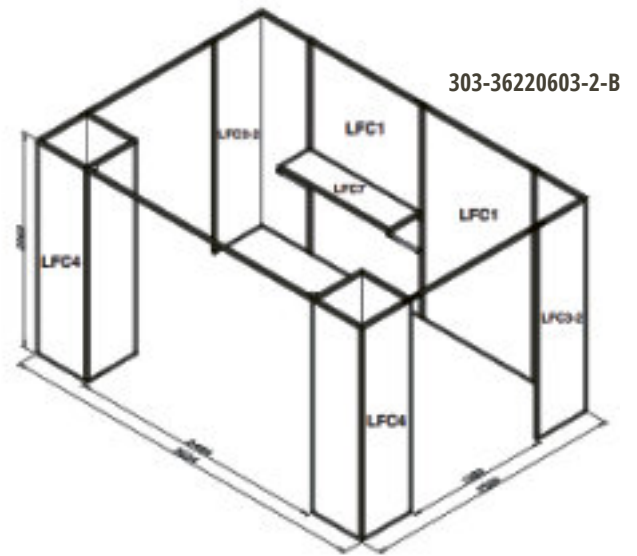

305-36220239-2-B

Lean Factory Corner con titolo / *Lean Factory Corner with title*

Dimensione (LxHxP) (mm) Cod.
 Width x Height (mm) Item-No.

3180 x 2620 x 2500

305-36220239-2-B

Fissaggio con piastre

Fixing with plates

N.B.: Nella realizzazione della struttura è obbligatorio che ciascun angolo sia composto da un elemento LFC3 o LFC4.

In the construction of the structure it is mandatory that each corner is composed of an LFC3 or LFC4 element.



LFC1, LFC2 / LFC1, LFC2

	Tipo <i>Type</i>	Descrizione <i>Description</i>	Facce scrivibili <i>Writable sides</i>	Cod. <i>Item-No.</i>	Dimensione (LxHxP) (mm) <i>Dimension (WxHxL) (mm)</i>
	LFC1	Modulo laterale / <i>Lateral module</i>	1	303-36220255-1	1244 x 2060 x 30
	LFC2	Modulo laterale / <i>Lateral module</i>	2	303-36220256-1-B	1244 x 2060 x 30
		<ul style="list-style-type: none"> - Struttura profilato 30 x 30 e tamponamento spessore 8 mm - Superfici magnetiche e scrivibili - Possibilità personalizzazione grafica - Altezza modificabile su richiesta 	<ul style="list-style-type: none"> - <i>Profiled structure 30 x 30 and 8 mm thickness panel</i> - <i>Magnetic surfaces</i> - <i>Graphic customization</i> - <i>Height adjustable on request</i> 		

LFC3 / LFC3

	Tipo <i>Type</i>	Descrizione <i>Description</i>	Facce scrivibili <i>Writable sides</i>	Cod. <i>Item-No.</i>	Dimensione (LxHxP) (mm) <i>Dimension (WxHxL) (mm)</i>
	LFC3-2	Modulo angolo / <i>Corner module</i>	2	303-36220257-2F-1	560 x 2060 x 560
	LFC3-3	Modulo angolo / <i>Corner module</i>	3	303-36220257-3F-1	560 x 2060 x 560
	LFC3-4	Modulo angolo / <i>Corner module</i>	4	303-36220257-4F-1	560 x 2060 x 560
		<ul style="list-style-type: none"> - Struttura profilato 30 x 30 e tamponamento spessore 8 mm - Superfici magnetiche e scrivibili - Possibilità personalizzazione grafica - Altezza modificabile su richiesta 	<ul style="list-style-type: none"> - <i>Profiled structure 30 x 30 and 8 mm thickness panel</i> - <i>Magnetic surfaces</i> - <i>Graphic customization</i> - <i>Height adjustable on request</i> 		

LFC4 / LFC4

	Tipo <i>Type</i>	Descrizione <i>Description</i>	Facce scrivibili <i>Writable sides</i>	Cod. <i>Item-No.</i>	Dimensione (LxHxP) (mm) <i>Dimension (WxHxL) (mm)</i>
	LFC4	Modulo colonna / <i>Column module</i>	4	303-36220258-1	560 x 2060 x 560
			<ul style="list-style-type: none"> - Struttura profilato 30 x 30 e tamponamento spessore 8 mm - Superfici magnetiche e scrivibili - Possibilità personalizzazione grafica - Altezza modificabile su richiesta 	<ul style="list-style-type: none"> - <i>Profiled structure 30 x 30 and 8 mm thickness panel</i> - <i>Magnetic surfaces</i> - <i>Graphic customization</i> - <i>Height adjustable on request</i> 	

LFC5 / LFC5

	Tipo <i>Type</i>	Descrizione <i>Description</i>	Cod. <i>Item-No.</i>	Dimensione (LxHxP) (mm) <i>Dimension (WxHxL) (mm)</i>
	LFC5	Mobile aperto / <i>Open cabinet</i>	303-36220259-1	2060 x 818 x 360
			<ul style="list-style-type: none"> - Struttura profilato 30 x 30 e tamponamento spessore 8 mm - 4 Piedini regolabili - Dimensione modificabile su richiesta 	<ul style="list-style-type: none"> - <i>Profiled structure 30 x 30 and 8 mm thickness panel</i> - <i>4 adjustable feet</i> - <i>Dimension adjustable on request</i>

Lavagne ed accessori / Visual Boards

LFC6 / LFC6

	Tipo <i>Type</i>	Descrizione <i>Description</i>	Cod. <i>Item-No.</i>	Dimensione (LxHxP) (mm) <i>Dimension (WxHxL) (mm)</i>
	LFC6	Mobile con ante / <i>Cabinet with doors</i>	303-36220260-1	2060 x 818 x 360
		<ul style="list-style-type: none"> - Struttura profilato 30 x 30 e tamponamento spessore 8 mm - 4 Piedini regolabili - 2 Ante apribili - Dimensione modificabile su richiesta 	<ul style="list-style-type: none"> - <i>Profiled structure 30 x 30 and 8 mm thickness panel</i> - <i>4 adjustable feet</i> - <i>2 opening doors</i> - <i>Dimension adjustable on request</i> 	

LFC7 / LFC7

	Tipo <i>Type</i>	Descrizione <i>Description</i>	Cod. <i>Item-No.</i>	Dimensione (LxHxP) (mm) <i>Dimension (WxHxL) (mm)</i>
	LFC7	Mensola aggiuntiva / <i>Additional shelf</i>	303-36220261-1	1244 x 390 x 360
		<ul style="list-style-type: none"> - Struttura profilato 30 x 30 e tamponamento spessore 8 mm - Dimensione modificabile su richiesta - Aste di sostegno e viti incluse 	<ul style="list-style-type: none"> - <i>Profiled structure 30 x 30 and 8 mm thickness panel</i> - <i>Dimension adjustable on request</i> - <i>Support rods and screws included</i> 	

LFC8 / LFC8

	Tipo <i>Type</i>	Descrizione <i>Description</i>	Cod. <i>Item-No.</i>	Dimensione (LxHxP) (mm) <i>Dimension (WxHxL) (mm)</i>
	LFC8	Fascione informativo (titolo) / <i>Information band (title)</i>	303-36220262-1	1000 x 560 x 30
		<ul style="list-style-type: none"> - Struttura profilato 30 x 30 e tamponamento spessore 8 mm - Dimensione modificabile su richiesta - Aste di sostegno e viti incluse - Lunghezza compresa tra i 1000 e i 3000 mm 	<ul style="list-style-type: none"> - <i>Profiled structure 30 x 30 and 8 mm thickness panel</i> - <i>Dimension adjustable on request</i> - <i>Support rods and screws included</i> - <i>Length between 1000 and 3000 mm</i> 	

LFC9 / LFC9

	Tipo <i>Type</i>	Descrizione <i>Description</i>	Cod. <i>Item-No.</i>	Dimensione (LxHxP) (mm) <i>Dimension (WxHxL) (mm)</i>
	LFC9	Kit piastra per unione pannelli <i>Plate for joining panels set</i>	303-36220263	58 x 118 x 4
		<ul style="list-style-type: none"> - Piastra in acciaio zincato spessore 4 mm (1 piastra ogni 2 moduli) - Viti incluse - 8 fori 	<ul style="list-style-type: none"> - <i>4 mm thick galvanized steel plate (1 plate every 2 modules)</i> - <i>Screws included</i> - <i>8 holes</i> 	

LFC10 / LFC10			
	Tipo <i>Type</i>	Descrizione <i>Description</i>	Cod. <i>Item-No.</i>
	LFC10	Profilo 30 x 30 / 30 x 30 profile	LPQ-3030
	<ul style="list-style-type: none"> - Profilo con cava da 8 mm - Materiale: Alluminio - Lunghezza massima 6070 mm 	<ul style="list-style-type: none"> - 8 mm with cove profile - Material: Aluminum - Maximum length 6070 mm 	

LFC11 / LFC11			
	Tipo <i>Type</i>	Descrizione <i>Description</i>	Cod. <i>Item-No.</i>
	LFC10	Kit angolare 30 x 60 per fissaggio pannelli <i>Angular set 30 x 60 for fixing panels</i>	303-36220264
	<ul style="list-style-type: none"> - Kit formato da: angolare in alluminio pressofuso, cuffia in PA nero e viti di fissaggio 	<ul style="list-style-type: none"> - Kit made up of: die-cast aluminum corner piece, black PA cap and fixing screws 	

Lean Factory Corner personalizzabile / <i>Customizable Lean Factory Corner</i>			
		<ul style="list-style-type: none"> - E' possibile richiedere un progetto per Lean Factory Corner personalizzato per dimensioni e componenti 	<ul style="list-style-type: none"> - It is possible to request a Lean Factory Corner project customized in terms of dimensions and components

Lavagne informative

Visual Boards

Le nostre lavagne in profilato d'alluminio sono realizzate con superfici smaltate, vetrificate a 800° C in materiale ecologico. Questo speciale trattamento le rende inalterabili, resistenti ai raggi solari, al calore elevato ed ai prodotti chimici, scrivibili e cancellabili. La migliore qualità tra le lavagne.

- Struttura in profilato 30x30 mm
- Pannello in acciaio porcellanato
- Possibilità di utilizzare qualsiasi tipo di pennarello
- Superficie cancellabile con solventi
- Personalizzabili graficamente
- Possibili composizioni multiple
- Misure personalizzabili

Surfaces, vitrified at 800° C in ecological material. This special treatment makes them unalterable, resistant to sunlight, high heat and chemical products, writable and erasable. The best quality among chalkboards.

- Structure in 30x30 mm profile
- Porcelain steel panel
- Ability to use any type of marker
- Solvent erasable surface
- Customizable graphically
- Possible multiple compositions
- Customizable measures

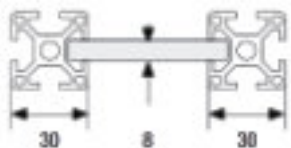

Lavagna a muro / Wall Visual Board

	Numero facce scrivibili <i>Number writable sides</i>	Numero facce magnetiche <i>Number magnetic sides</i>	Cod. <i>Item-No.</i>	Dimensione (LxHxH tot) (mm) <i>Dimension (WxHxH) (mm)</i>
	1	2	A1-1000	1000 x 1208 x 1268
	1	2	A1-1500	1500 x 1208 x 1268
	1	2	A1-2000	2000 x 1208 x 1268

Lavagna centrale / Central Visual Board

	Numero facce scrivibili <i>Number writable sides</i>	Numero facce magnetiche <i>Number magnetic sides</i>	Cod. <i>Item-No.</i>	Dimensione (LxHxH tot) (mm) <i>Dimension (WxHxH) (mm)</i>
	1	2	B1-1000	1000 x 1208 x 2000
	1	2	B1-1500	1500 x 1208 x 2000
	1	2	B1-2000	2000 x 1208 x 2000
	2	2	B2-1000-B	1000 x 1208 x 2000
	2	2	B2-1500-B	1500 x 1208 x 2000
	2	2	B2-2000-B	2000 x 1208 x 2000

Lavagna laterale / Side Visual Board

	Numero facce scrivibili <i>Number writable sides</i>	Numero facce magnetiche <i>Number magnetic sides</i>	Cod. <i>Item-No.</i>	Dimensione (LxHxH tot) (mm) <i>Dimension (WxHxH) (mm)</i>
	1	2	C1-1000	1000 x 1208 x 2000
	1	2	C1-1500	1500 x 1208 x 2000
	1	2	C1-2000	2000 x 1208 x 2000
	2	2	C2-1000-B	1000 x 1208 x 2000
	2	2	C2-1500-B	1500 x 1208 x 2000
	2	2	C2-2000-B	2000 x 1208 x 2000

Lavagna personalizzabile rinforzata / Customizable HD Visual Board

	- Esiste anche la possibilità di richiedere personalizzazioni della lunghezza per dimensioni superiori ai 2000 mm che prevedono strutture rinforzate	- There is also the possibility of requesting length customizations for dimensions greater than 2000 mm which include reinforced structures

Lavagne ed accessori / Visual Boards

Lavagna Basic / Basic Visual Board					
	Numero facce scrivibili <i>Number writable sides</i>	Numero facce magnetiche <i>Number magnetic sides</i>	Numero mensole <i>Number shelves</i>	Cod. <i>Item-No.</i>	Dimensione (LxHxH tot) (mm) <i>Dimension (WxHxH) (mm)</i>
	-	-	1	V0-1000S-1	1000 x 1208 x 2000
	-	-	1	V0-1500S-1	1500 x 1208 x 2000
	-	-	1	V0-2000S-1	2000 x 1208 x 2000
	- Struttura in profilato 30 x 30, tamponamento spessore 5 mm			- Structure in 30 x 30 profile, panel 5 mm thickness	

Lavagna Basic / Basic Visual Board					
	Numero facce scrivibili <i>Number writable sides</i>	Numero facce magnetiche <i>Number magnetic sides</i>	Numero mensole <i>Number shelves</i>	Cod. <i>Item-No.</i>	Dimensione (LxHxH tot) (mm) <i>Dimension (WxHxH) (mm)</i>
	-	-	2	V0-1000D-1	1000 x 1208 x 2000
	-	-	2	V0-1500D-1	1500 x 1208 x 2000
	-	-	2	V0-2000D-1	2000 x 1208 x 2000
	- Struttura in profilato 30 x 30, tamponamento spessore 5 mm			- Structure in 30 x 30 profile, panel 5 mm thickness	

Lavagna Visual / Visual Board					
	Numero facce scrivibili <i>Number writable sides</i>	Numero facce magnetiche <i>Number magnetic sides</i>	Numero mensole <i>Number shelves</i>	Cod. <i>Item-No.</i>	Dimensione (LxHxH tot) (mm) <i>Dimension (WxHxH) (mm)</i>
	1	2	1	V1-1000S-1	1000 x 1208 x 2000
	1	2	1	V1-1500S-1	1500 x 1208 x 2000
	1	2	1	V1-2000S-1	2000 x 1208 x 2000
	- Struttura in profilato 30 x 30, tamponamento spessore 5 mm			- Structure in 30 x 30 profile, panel 5 mm thickness	

Lavagna Visual / Visual Board					
	Numero facce scrivibili <i>Number writable sides</i>	Numero facce magnetiche <i>Number magnetic sides</i>	Numero mensole <i>Number shelves</i>	Cod. <i>Item-No.</i>	Dimensione (LxHxH tot) (mm) <i>Dimension (WxHxH) (mm)</i>
	1	2	2	V1-1000D-1	1000 x 1208 x 2000
	1	2	2	V1-1500D-1	1500 x 1208 x 2000
	1	2	2	V1-2000D-1	2000 x 1208 x 2000
	- Struttura in profilato 30 x 30, tamponamento spessore 5 mm			- Structure in 30 x 30 profile, panel 5 mm thickness	

Lavagna Visual / Visual Board					
	Numero facce scrivibili <i>Number writable sides</i>	Numero facce magnetiche <i>Number magnetic sides</i>	Numero mensole <i>Number shelves</i>	Cod. <i>Item-No.</i>	Dimensione (LxHxH tot) (mm) <i>Dimension (WxHxH) (mm)</i>
	2	2	1	V2-1000S-B	1000 x 1208 x 2000
	2	2	1	V2-1500S-B	1500 x 1208 x 2000
	2	2	1	V2-2000S-B	2000 x 1208 x 2000
	- Struttura in profilato 30 x 30, tamponamento spessore 5 mm			- Structure in 30 x 30 profile, panel 5 mm thickness	

Lavagna Visual / Visual Board					
	Numero facce scrivibili <i>Number writable sides</i>	Numero facce magnetiche <i>Number magnetic sides</i>	Numero mensole <i>Number shelves</i>	Cod. <i>Item-No.</i>	Dimensione (LxHxH tot) (mm) <i>Dimension (WxHxH) (mm)</i>
	2	2	2	V2-1000D-B	1000 x 1208 x 2000
	2	2	2	V2-1500D-B	1500 x 1208 x 2000
	2	2	2	V2-2000D-B	2000 x 1208 x 2000
	- Struttura in profilato 30 x 30, tamponamento spessore 5 mm			- Structure in 30 x 30 profile, panel 5 mm thickness	

Titolo magnetico e scrivibile / <i>Magnetic and writable title</i>	
	<p>- Tutte le lavagne informative sono realizzabili anche con titolo magnetico scrivibile nelle altezze di 250 o 350 mm. Da definire in offerta</p> <p>- All information boards can also be made with a magnetic title that can be written on in heights of 250 or 350 mm.</p>

Lavagne informative in GF

GF Visual Board

Le lavagne informative in profilo Green Frame sono studiate per permettere il facile assemblaggio dei vari componenti per la creazione di strutture personalizzate (a muro, con gambe, con titolo, ecc.).

- Massima flessibilità
- Assemblaggio veloce
- Leggerezza e ottimo impatto estetico
- Pannello in acciaio porcellanato
- Possibilità di utilizzare qualunque pennarello
- Superficie cancellabile con solventi
- Superficie magnetica
- Possibilità di personalizzazione grafica
- Misure personalizzabili

The Green Frame profile Visual Boards are designed to allow easy assembly of the various components for the creation of customized structures (wall, with legs, with title, etc.).

- *Maximum flexibility*
- *Fast assembly*
- *Lightness and excellent aesthetic impact*
- *Porcelain steel panel*
- *Possibility to use any marker*
- *Solvent erasable surface*
- *Magnetic surface*
- *Possibility of graphic customization*
- *Customizable measures*

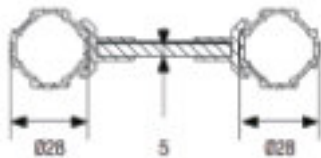

Pannello magnetico e scrivibile / *Magnetic writable board*

	Numero facce scrivibili <i>Number writable sides</i>	Numero facce magnetiche <i>Number magnetic sides</i>	Cod. <i>Item-No.</i>	Dimensione (LxHxH tot) (mm) <i>Dimension (WxHxH) (mm)</i>
	1	2	P1-1000GF	1000 x 1195 x 1283
	1	2	P1-2000GF	2000 x 1195 x 1283
	2	2	P2-1000GF-B	1000 x 1195 x 1283
	2	2	P2-2000GF-B	2000 x 1195 x 1283

Kit gamba / *Board leg set*

	Descrizione <i>Description</i>	Cod. <i>Item-No.</i>
	Kit gamba con ruote Ø 50 mm con freno / <i>Leg with wheels set Ø 50 mm with brake</i>	KGRC-GF-1
	Kit gamba con piedini Ø 30 mm / <i>Leg with feet set Ø 30 mm</i>	KGP3-GF-1
	- Il kit contiene i componenti per n.1 gamba <i>- Set contains the components for 1 leg</i>	

Kit fissaggio a muro / *Wall fixing set*

	Descrizione <i>Description</i>	Cod. <i>Item-No.</i>
	Kit fissaggio a muro / <i>Wall fixing set</i>	KFM3-GF
	- Il kit contiene n. 3 pezzi - Si consiglia l'uso di 1 kit ogni metro lineare di lavagna <i>- Set contains 3 pieces - We recommend using 1 kit for every linear meter of board</i>	

Kit cerniere / *Hingers set*

	Descrizione <i>Description</i>	Cod. <i>Item-No.</i>
	Kit cerniera Dx. / <i>Right hingers set</i>	KCDX-GF
	Kit cerniera Sx. / <i>Left hingers set</i>	KCSX-GF
	- Il kit contiene n. 2 pezzi <i>- Set contains 2 pieces</i>	

Titolo magnetico e scrivibile in GF / *GF Magnetic and writable title*

	Numero facce scrivibili <i>Number writable sides</i>	Numero facce magnetiche <i>Number magnetic sides</i>	Cod. <i>Item-No.</i>	Dimensione (LxH) (mm) <i>Dimension (WxH) (mm)</i>
	1	2	T1-1000B-GF	1000 x 250
	1	2	T1-2000B-GF	2000 x 250
	1	2	T1-1000A-GF	1000 x 350
	1	2	T1-2000A-GF	2000 x 350
	2	2	T2-1000B-GF	1000 x 250
	2	2	T2-2000B-GF	2000 x 250
	2	2	T2-1000A-GF	1000 x 350
	2	2	T2-2000A-GF	2000 x 350

Lavagne ed accessori / Visual Boards

Lavagna Basic in GF / GF Basic visual board

	Numero facce scrivibili <i>Number writable sides</i>	Numero facce magnetiche <i>Number magnetic sides</i>	Numero mensole <i>Number shelves</i>	Cod. <i>Item-No.</i>	Dimensione (LxHxH tot) (mm) <i>Dimension (WxHxH) (mm)</i>
	-	-	1	V0-1000S-GF-1	1000 x 1195 x 2000
	-	-	1	V0-1500S-GF-1	1500 x 1195 x 2000
	-	-	1	V0-2000S-GF-1	2000 x 1195 x 2000
	- Struttura in profilato Ø 28 mm, tamponamento spessore 5 mm			- Structure in Ø 28 mm profile, panel 5 mm thickness	

Lavagna Basic in GF / GF Basic visual board

	Numero facce scrivibili <i>Number writable sides</i>	Numero facce magnetiche <i>Number magnetic sides</i>	Numero mensole <i>Number shelves</i>	Cod. <i>Item-No.</i>	Dimensione (LxHxH tot) (mm) <i>Dimension (WxHxH) (mm)</i>
	-	-	2	V0-1000D-GF-1	1000 x 1195 x 2000
	-	-	2	V0-1500D-GF-1	1500 x 1195 x 2000
	-	-	2	V0-2000D-GF-1	2000 x 1195 x 2000
	- Struttura in profilato Ø 28 mm, tamponamento spessore 5 mm			- Structure in Ø 28 mm profile, panel 5 mm thickness	

Lavagna Visual in GF / GF Visual board

	Numero facce scrivibili <i>Number writable sides</i>	Numero facce magnetiche <i>Number magnetic sides</i>	Numero mensole <i>Number shelves</i>	Cod. <i>Item-No.</i>	Dimensione (LxHxH tot) (mm) <i>Dimension (WxHxH) (mm)</i>
	1	2	1	V1-1000S-GF-1	1000 x 1195 x 2000
	1	2	1	V1-1500S-GF-1	1500 x 1195 x 2000
	1	2	1	V1-2000S-GF-1	2000 x 1195 x 2000
	- Struttura in profilato Ø 28 mm, tamponamento spessore 5 mm			- Structure in Ø 28 mm profile, panel 5 mm thickness	

Lavagna Visual in GF / GF Visual board

	Numero facce scrivibili <i>Number writable sides</i>	Numero facce magnetiche <i>Number magnetic sides</i>	Numero mensole <i>Number shelves</i>	Cod. <i>Item-No.</i>	Dimensione (LxHxH tot) (mm) <i>Dimension (WxHxH) (mm)</i>
	1	2	2	V1-1000D-GF-1	1000 x 1195 x 2000
	1	2	2	V1-1500D-GF-1	1500 x 1195 x 2000
	1	2	2	V1-2000D-GF-1	2000 x 1195 x 2000
	- Struttura in profilato Ø 28 mm, tamponamento spessore 5 mm			- Structure in Ø 28 mm profile, panel 5 mm thickness	

Lavagna Visual in GF / GF Visual board					
	Numero facce scrivibili <i>Number writable sides</i>	Numero facce magnetiche <i>Number magnetic sides</i>	Numero mensole <i>Number shelves</i>	Cod. <i>Item-No.</i>	Dimensione (LxHxH tot) (mm) <i>Dimension (WxHxH) (mm)</i>
	2	2	1	V2-1000S-GF-B	1000 x 1195 x 2000
	2	2	1	V2-1500S-GF-B	1500 x 1195 x 2000
	2	2	1	V2-2000S-GF-B	2000 x 1195 x 2000
	- Struttura in profilato Ø 28 mm, tamponamento spessore 5 mm		- Structure in Ø 28 mm profile, panel 5 mm thickness		

Lavagna Visual in GF / GF Visual board					
	Numero facce scrivibili <i>Number writable sides</i>	Numero facce magnetiche <i>Number magnetic sides</i>	Numero mensole <i>Number shelves</i>	Cod. <i>Item-No.</i>	Dimensione (LxHxH tot) (mm) <i>Dimension (WxHxH) (mm)</i>
	2	2	2	V2-1000D-GF-B	1000 x 1195 x 2000
	2	2	2	V2-1500D-GF-B	1500 x 1195 x 2000
	2	2	2	V2-2000D-GF-B	2000 x 1195 x 2000
	- Struttura in profilato Ø 28 mm, tamponamento spessore 5 mm		- Structure in Ø 28 mm profile, panel 5 mm thickness		

Lean CUBE

Cube rotating

I nostri Lean CUBE in profilato d'alluminio sono realizzati con superfici smaltate, vetrificate a 800°C in materiale ecologico (vedi lavagne informative). Possibilità di personalizzazione delle misure. Base su ruote o piattaforma girevole.

- Struttura in profilato d'alluminio 30 x 30
- Pannello in acciaio porcellanato
- Possibilità di utilizzare qualsiasi tipo di pennarello
- Superficie cancellabile con solventi
- Superficie magnetica
- Misure personalizzabili
- Possibilità di personalizzazione grafica

Our Lean CUBE in aluminum profile are made with enamelled surfaces, vitrified at 800° in ecological material (see information boards). Possibility of customizing the measures. Base on wheels or turntable.

- *Structure in aluminum profile 30 x 30*
- *Porcelain steel panel*
- *Possibility to use any type of marker*
- *Solvent erasable surface*
- *Magnetic surface*
- *Customizable measures*
- *Possibility of graphic customization*

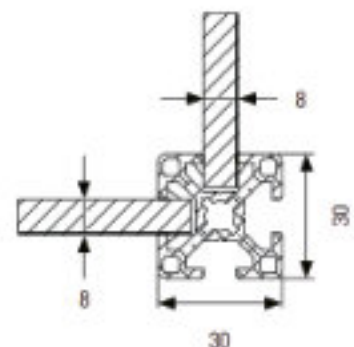

Lean CUBE su base girevole / *Lean CUBE on swivel base*

	Descrizione <i>Description</i>	Cod. <i>Item-No.</i>	Dimensione (LxHxP) (mm) <i>Dimension (WxHxL) (mm)</i>
	Lean CUBE su base girevole / <i>Lean CUBE on swivel base</i>	Q4-0065	560 x 1819 x 560
	Lean CUBE su base girevole / <i>Lean CUBE on swivel base</i>	Q4-0033-B	760 x 1819 x 760
	- Struttura in profilato 30 x 30 mm	- Structure in 30 x 30 mm profile	

Lean CUBE su ruote / *Lean CUBE on wheels*

	Descrizione <i>Description</i>	Cod. <i>Item-No.</i>	Dimensione (LxHxP) (mm) <i>Dimension (WxHxL) (mm)</i>
	Lean CUBE su ruote / <i>Lean CUBE on wheels</i>	Q4-0031-1	560 x 2000 x 560
	Lean CUBE su ruote / <i>Lean CUBE on wheels</i>	Q4-0072	760 x 2000 x 760
	- Struttura in profilato 30 x 30 mm	- Structure in 30 x 30 mm profile	

Lean CUBE con titolo / *Lean CUBE with title*

	Descrizione <i>Description</i>	Cod. <i>Item-No.</i>	Dimensione (LxHxP) (mm) <i>Dimension (WxHxL) (mm)</i>
	Lean CUBE con titolo, a pavimento / <i>Lean CUBE with title, on floor</i>	Q4-0066	560 x 1931 x 560
	Lean CUBE con titolo, a pavimento / <i>Lean CUBE with title, on floor</i>	Q4-0047-1	760x 1931 x 760
	- Struttura in profilato 30 x 30 mm	- Structure in 30 x 30 mm profile	

Lean CUBE 3 settori / *Lean CUBE 3 sections*

	Descrizione <i>Description</i>	Cod. <i>Item-No.</i>	Dimensione (LxHxP) (mm) <i>Dimension (WxHxL) (mm)</i>
	Lean CUBE con 3 settori, su ruote / <i>Lean CUBE 3 sections, on wheels</i>	Q4-0048-1	1460 x 2058 x 1460
	- Struttura in profilato 30 x 30 mm	- Structure in 30 x 30 mm profile	

Lean CUBE personalizzati / *Customizable Lean CUBE*

	- I lean CUBE sono personalizzabili secondo specifiche esigenze del cliente	- The lean CUBE can be customized according to specific customer needs	
---	---	--	--

Lean CUBE in GF

Lean CUBE GF

Come per le lavagne informative in GF i Lean CUBE sono un ottimo connubio tra leggerezza, praticità e eccellente impatto estetico. Personalizzabili in tutte le loro dimensioni.

- Struttura in profilo GF Ø 28 mm
- Massima flessibilità e leggerezza
- Eccellente impatto estetico
- Pannello in acciaio porcellanato
- Possibilità di utilizzare qualsiasi tipo di pennarello
- Superficie cancellabile con solventi
- Superficie magnetica
- Misure personalizzabili
- Possibilità di personalizzazione grafica

As for the information boards in GF, the Lean CUBES are an excellent combination of lightness, practicality and excellent aesthetic impact. Customizable in all their dimensions.

- Structure in 28 mm GF profile
- Maximum flexibility and lightness
- Excellent aesthetic impact
- Porcelain steel panel
- Ability to use any type of marker
- Solvent erasable surface
- Magnetic surface
- Customizable measures
- Possibility of graphic customization

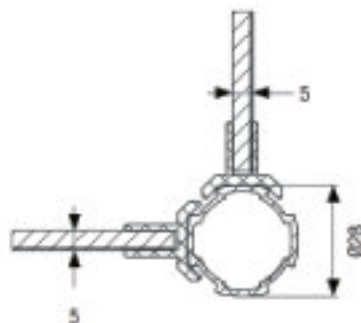

Lean CUBE in GF / <i>GF Lean CUBE</i>			
	Descrizione <i>Description</i>	Cod. <i>Item-No.</i>	Dimensione (LxHxP) (mm) <i>Dimension (WxHxL) (mm)</i>
	Lean CUBE GF / <i>GF Lean CUBE</i>	Q4-0045-1	588 x 2093 x 588
	Lean CUBE GF / <i>GF Lean CUBE</i>	Q4-0046-1	788 x 2093 x 788
	- Struttura in profilo GF - Magnetico e scrivibile	- <i>Structure in GF profile</i> - <i>Magnetic and writable</i>	

Lean CUBE in GF girevole / <i>Swivel GF Lean CUBE</i>			
	Descrizione <i>Description</i>	Cod. <i>Item-No.</i>	Dimensione (LxHxP) (mm) <i>Dimension (WxHxL) (mm)</i>
	Lean CUBE GF girevole / <i>Swivel GF Lean CUBE</i>	Q4-0041-1	588 x 2093 x 588
	Lean CUBE GF girevole / <i>Swivel GF Lean CUBE</i>	Q4-0042-1	788 x 2093 x 788
	- Struttura in profilo GF - Parte superiore magnetica e scrivibile	- <i>Structure in GF profile</i> - <i>Top magnetic and writable</i>	

Lean CUBE in GF due settori / <i>Two sector GF Lean CUBE</i>			
	Descrizione <i>Description</i>	Cod. <i>Item-No.</i>	Dimensione (LxHxP) (mm) <i>Dimension (WxHxL) (mm)</i>
	Lean CUBE GF 2 settori / <i>2 sectors GF Lean CUBE</i>	Q4-0040-2	588 x 2093 x 588
	Lean CUBE GF 2 settori / <i>2 sectors GF Lean CUBE</i>	Q4-0035-1	788 x 2093 x 788
	- Struttura in profilo GF - Parte superiore magnetica e scrivibile	- <i>Structure in GF profile</i> - <i>Top magnetic and writable</i>	

Lean CUBE in GF con porta / <i>GF Lean CUBE with door</i>			
	Descrizione <i>Description</i>	Cod. <i>Item-No.</i>	Dimensione (LxHxP) (mm) <i>Dimension (WxHxL) (mm)</i>
	Lean CUBE GF con porta / <i>GF Lean CUBE with door</i>	Q4-0032-1	588 x 2093 x 588
	Lean CUBE GF con porta / <i>GF Lean CUBE with door</i>	Q4-0044-1	788 x 2093 x 788
	- Struttura in profilo GF - Parte superiore magnetica e scrivibile - Con porta	- <i>Structure in GF profile</i> - <i>Top magnetic and writable</i> - <i>With door</i>	

Kit piedini e ruote / <i>Set feet and wheels</i>			
	Descrizione <i>Description</i>	Cod. <i>Item-No.</i>	
	Kit piedini Ø 30 mm / <i>Set feet Ø 30 mm</i>	KLP3-GF	
	Kit ruote Ø 50 mm con freno / <i>Set wheels Ø 50 mm with brake</i>	KLRC-GF	
	- Kit composto da 4 pezzi, compatibile anche con Lean CUBE	- <i>Set consisting of 4 pieces, compatible with Lean CUBE</i>	

Totem

Totem

Totem informativo con struttura in profilo tubolare \varnothing 28 mm. Ideale per una identificazione mobile ma stabile.

Ulteriori dimensioni su richiesta.

*Information totem with \varnothing 28 mm tubular profile structure
Ideal for mobile but stable identification.*

Further dimensions on request.



Totem con base / Totem with base				
	Per documento formato <i>For documents format</i>	N. Facce scrivibili e magnetiche <i>N. Sides writable and magnetic</i>	Cod. <i>Item-No.</i>	Altezza (mm) <i>Hight (mm)</i>
	DIN A4 vert. / DIN A4 portr.	2	TT-0038	1700
	DIN A4 orizz. / DIN A4 landsc.	2	TT-0039	1700

Totem con ruote / Totem with wheels				
	Formato <i>Format</i>	N. Facce scrivibili e magnetiche <i>N. Sides writable and magnetic</i>	Cod. <i>Item-No.</i>	Altezza (mm) <i>Hight (mm)</i>
	DIN A4 vert. / DIN A4 portr.	2	TT-0045	1700
	DIN A4 orizz. / DIN A4 landsc.	2	TT-0044	1700

Personalizzazioni grafiche

Graphic personalization

I nostri pannelli scrivibili possono essere personalizzate su richiesta con loghi, grigliati, riquadri ed altro con l'applicazione di vinile acrilico. Le realizzazioni possono essere monocromatiche oppure in quadricromia, a stampa o a intaglio a seconda della complessità del layout.

Our panels can be customized on request with logos, grids, squares and more with the application of acrylic vinyl. The creations can be monochrome or four-colour, printed or engraved depending on the complexity of the layout.



A3 PROBLEM SOLVING

1 Initial Problem Perception

Process/Dept	Type	A3 Category	Problem Owner

2 Problem Clarification

Problem Statement	Target Setting
-------------------	----------------

3 Point Of Cause

4 Containment

Declaration/Action	Who	When	Where	Effectivity %

5 Cause & Effect (Fishbone)

6 Cause Investigation

How will you investigate	What you found	Result

Direct Cause: _____

Indirect Cause: _____

Why _____ Because _____

Why _____ Because _____

Why _____ Because _____

Why _____ Because _____

Root Cause: _____

7 Countermeasures (Preventive action)

Countermeasure to prevent recurrence	Who	When	Status	Effectivity %

Countermeasures initially implemented: _____

Standardize & Share Best Practice

CARICO	1	2	3	4	5	6
In Lavorazione	In Lavorazione	In Lavorazione	In Lavorazione	In Lavorazione	In Lavorazione	In Lavorazione

7	8	9	10	11	12	CARICO
In Lavorazione	In Lavorazione	In Lavorazione	In Lavorazione	In Lavorazione	In Lavorazione	In Lavorazione

In Spedizioni	In Spedizioni	In Spedizioni	In Spedizioni	In Spedizioni	In Spedizioni	In Spedizioni

Possibilità di scrittura sia con pennarelli polverizzabili che indelebili.

Possibility of writing with both valorisable and indelible markers.

Accessori
Accessories

Porta pennarello magnetico / Marker Holder, magnetic

 		Cod. Item-No.	
		VB-SH-MA	
Portapennarello magnetico bianco per 1 pennarello Ø 10 mm		Magnetic holder for pens and board markers with a max. diameter of 10 mm.	

Porta pennarelli magnetico / Whiteboard Marker Holder, magnetic

 		Cod. Item-No.	
		VB-SH4-MA	
- Porta pennarelli magnetico bianco per 4 pennarelli		- For all magnetic whiteboards - Magnetic - Can hold up to 4 board markers	

Cancellino e Refill cancellino / Board Assistant, magnetic

		Descrizione Description	Cod. Item-No.	Confezione Pack
 	Cancellino / Board eraser	VB-BA-MA	1 pezzo / piece	
	Refill cancellino / Refill Blotting Paper	VB-LP	100 pezzi / pieces	
		- Cancellino magnetico con feltro e base magnetica con porta pennarelli - Capienza fino a 7 pennarelli	- For all magnetic whiteboards - Magnetic storage box - Can hold up to 7 board markers - Lid serves as a board wiper	

Pennarelli / Whiteboard Markers

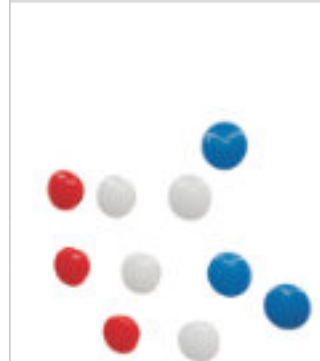

		Descrizione <i>Description</i>	Cod. <i>Item-No.</i>	Confezione <i>Pack</i>
		Pennarelli punta tonda colodi assortiti (polverizzabili) <i>Assorted color round tip felt-tip pens (pulverizable)</i>	50.0010.0003	4 pezzi / <i>pieces</i>
		Pennarelli punta scalpello colodi assortiti (polverizzabili) <i>Assorted color chisel tip felt-tip pens (pulverizable)</i>	50.0010.0004	4 pezzi / <i>pieces</i>
		Pennarelli base acqua colodi assortiti (base acqua) <i>Water-based markers assorted colors (water-based)</i>	50.0010.0006	4 pezzi / <i>pieces</i>

Magneti rotondi / Round magnets

		Descrizione <i>Description</i>	Cod. <i>Item-No.</i>	Dimensione (Ø mm) <i>Dimension (Ø mm)</i>	Confezione <i>Pack</i>
		Magnete Rotondo rosso / <i>Red Rounded Magnet</i>	50.0010.0021	20	12 pezzi / <i>pieces</i>
		Magnete Rotondo bianco / <i>White Rounded Magnet</i>	50.0010.0022	20	12 pezzi / <i>pieces</i>
		Magnete Rotondo blu / <i>Blue Rounded Magnet</i>	50.0010.0023	20	12 pezzi / <i>pieces</i>
		Magnete Rotondo giallo / <i>Yellow Rounded Magnet</i>	50.0010.0024	20	12 pezzi / <i>pieces</i>
		Magnete Rotondo verde / <i>Green Rounded Magnet</i>	50.0010.0025	20	12 pezzi / <i>pieces</i>
		Magnete Rotondo nero / <i>Black Rounded Magnet</i>	50.0010.0026	20	12 pezzi / <i>pieces</i>
		Magnete Rotondo rosso / <i>Red Rounded Magnet</i>	50.0010.0031	30	12 pezzi / <i>pieces</i>
		Magnete Rotondo bianco / <i>White Rounded Magnet</i>	50.0010.0032	30	12 pezzi / <i>pieces</i>
		Magnete Rotondo blu / <i>Blue Rounded Magnet</i>	50.0010.0033	30	12 pezzi / <i>pieces</i>
		Magnete Rotondo giallo / <i>Yellow Rounded Magnet</i>	50.0010.0034	30	12 pezzi / <i>pieces</i>
		Magnete Rotondo verde / <i>Green Rounded Magnet</i>	50.0010.0035	30	12 pezzi / <i>pieces</i>
		Magnete Rotondo nero / <i>Black Rounded Magnet</i>	50.0010.0036	30	12 pezzi / <i>pieces</i>
		Magnete Rotondo rosso / <i>Red Rounded Magnet</i>	50.0010.0041	40	12 pezzi / <i>pieces</i>
		Magnete Rotondo bianco / <i>White Rounded Magnet</i>	50.0010.0042	40	12 pezzi / <i>pieces</i>
		Magnete Rotondo blu / <i>Blue Rounded Magnet</i>	50.0010.0043	40	12 pezzi / <i>pieces</i>
		Magnete Rotondo giallo / <i>Yellow Rounded Magnet</i>	50.0010.0044	40	12 pezzi / <i>pieces</i>
		Magnete Rotondo verde / <i>Green Rounded Magnet</i>	50.0010.0045	40	12 pezzi / <i>pieces</i>
		Magnete Rotondo nero / <i>Black Rounded Magnet</i>	50.0010.0046	40	12 pezzi / <i>pieces</i>

Accessori Accessories

Magneti smile colorati / Magnets Smiley

		Descrizione Description	Cod. Item-No.	Dimensione Dimension	Colore Color	Confezione Pack
 		Triste / Sad	VB-HMS-01	Ø 36 mm	Rosso / Red	10 pezzi / pieces
		Neutrale / Neutral	VB-HMS-04	Ø 36 mm	Giallo / Yellow	10 pezzi / pieces
		Sorridente / Laughing	VB-HMS-05	Ø 36 mm	Verde / Green	10 pezzi / pieces
		Faccine stampate su calamite plastificate. Elevata adesione e buona leggibilità	Smileys printed on plastic-coated magnets. High adhesivity and good legibility			

Porta etichette magnetico standard / Label Holder for value Stream Mapping symbols

		Descrizione Description	Cod. Item-No.	Dimensione (LxH) Dimension (WxH)	Cartoncino Cardboards	Confezione Pack
 		Grande / Large	HE148-105	105 x 148 mm	ET105-148	50 pezzi / pieces
		Piccolo / Small	HE547-75	75 x 47 mm	ET475	50 pezzi / pieces
		Cartellini a pag. 110 / Cardboard labels page 110				

Porta dox da sospensione / Filing system

		Cod. Item-No.
 		VB-ZB002
		<ul style="list-style-type: none"> - Progettato per agganciarsi al nostro profilo in alluminio - Ideato per cartelle di archiviazione - Crea spazio e tutto è a portata di mano <ul style="list-style-type: none"> - For attaching to our aluminum profiles (visual boards) - Suitable for filing folders - Creates space, folders are immediately at hand

Accessori
Accessories

Simboli magnetici double face / Double face magnetic symbols

	Descrizione Description	Cod. Item-No.	Dimensione (LxH) (mm) Dimension (LxH) (mm)	Confezione Pack
	Omini magnetici rosso / verde Magnetic red and green men	LP-SMOD	98 x 105	5 pezzi / pieces
	Freccie magnetici rosso / verde Magnetic red and green arrows	LP-SMFD	125/40 x 80	5 pezzi / pieces
	Cerchi magnetici rosso / verde Magnetic red and green circle	LP-SMCD	Ø 50	5 pezzi / pieces
	Smile magnetici rosso / verde Magnetic red and green smiles	LP-SMCS	Ø 50	5 pezzi / pieces
	Simboli magnetici double face rosso / verde per evidenziare l'avanzamento dei progetti Lean. Realizzati in magnete morbido di spessore 1,1 mm.			Red / green double sided magnetic symbols to highlight the progress of Lean projects. Made of 1.1mm thick soft magnet.

Simboli magnetici / Magnetic symbols

	Descrizione Description	Cod. Item-No.	+ Colore + Color	Dimensione (LxH) (mm) Dimension (LxH) (mm)	Confezione Pack
	Nuvole magnetiche Magnetic clouds	LP-SMN-	01 02 03 04 05 99*	135 x 95	5 pezzi / pieces
	Cerchi magnetici Magnetic circles	LP-SMC-	01 - 03 04 05 -	Ø 95	5 pezzi / pieces
	Freccie magnetiche Magnetic arrows	LP-SMF-	01 - - - - -	15/5 x 60	5 pezzi / pieces
	Simboli magnetici in colori assortiti di forma circolare, nuvola o freccia per le più svariate esigenze. Realizzati in materiale magnetico morbido di spessore 0,9 mm. Superficie scrivibile con pennarelli a base d'acqua.			Magnetic symbols in assorted colors in a circular, cloud or arrow shape for the most varied needs. Made of 0.9 mm thick soft magnetic material. Writable surface with water-based markers.	
	*colori assortiti			*assorted colors	

Fogli magnetici stampabili / Magnetic sheet A4 for inkjet printer

	Descrizione Description	Cod. Item-No.	Formato Format	Confezione Pack
	Fogli magnetici stampabili Magnetic sheet A4 for inkjet printer	LP-FM-A4	DIN A4	10 pezzi / pieces
	Permettono di stampare le vostre informazioni, simboli, immagini, ecc. direttamente sulla superficie bianca mediante l'utilizzo di qualsiasi stampante a getto d'inchiostro rendendo così magnetiche le vostre realizzazioni. Realizzato in magnete morbido con spessore 0,15 mm.			They allow you to print your information, symbols, images, etc. directly on the white surface using any inkjet printer, thus making your creations magnetic. Made of 0.15 mm thick soft magnet.

ESD- Scarica elettrostatica

ESD-electro static discharge

La nostra speciale soluzione per prevenire cariche elettrostatiche (ESD) durante il processo

Lavori con assiemi o componenti elettrostaticamente sensibili? Per questi casi abbiamo sviluppato varianti speciali dei nostri prodotti che impediscono la carica elettrostatica. Lavoriamo, ad esempio, con pellicole speciali in PVC che dissipano in modo permanente eventuali cariche che ne derivano. Ciò garantisce che nessuno dei tuoi prodotti venga danneggiato o distrutto durante i processi di stoccaggio.

Questo è il significato del termine ESD.

L'attrito e la successiva separazione di due oggetti creano queste cariche. In caso di cariche particolarmente forti, ciò può anche provocare scintille visibili.

Una scarica percepibile dall'uomo contiene ca. 3000 Volt, mentre 30 Volt sono sufficienti per distruggere un componente elettrostaticamente sensibile o un gruppo elettrostaticamente sensibile.

Our special solutions prevent electrostatic charges (ESD) during the work process

You work with electrostatically sensitive assemblies or components? For such cases, we have developed special variants of our popular products that prevent electrostatic charging. We work with special PVC films, for example, which permanently dissipate any charges that arise. This ensures that none of your products are damaged or destroyed completely during your storage processes.

This is what ESD means

Electrostatic charges can be absorbed and released by the human body. Friction and the subsequent separation of two objects create these charges. In case of particularly strong charges, this may even result in visible sparking.

A discharge that is perceptible for humans contains approx. 3000 Volts, where as 30 Volts are sufficient to destroy an electrostatically sensitive component or an electrostatically sensitive assembly.



Portadocumenti

Visual Pockets



Sistema Kanban

Inserting Systems

Prodotti ESD

Infographic ESD Products

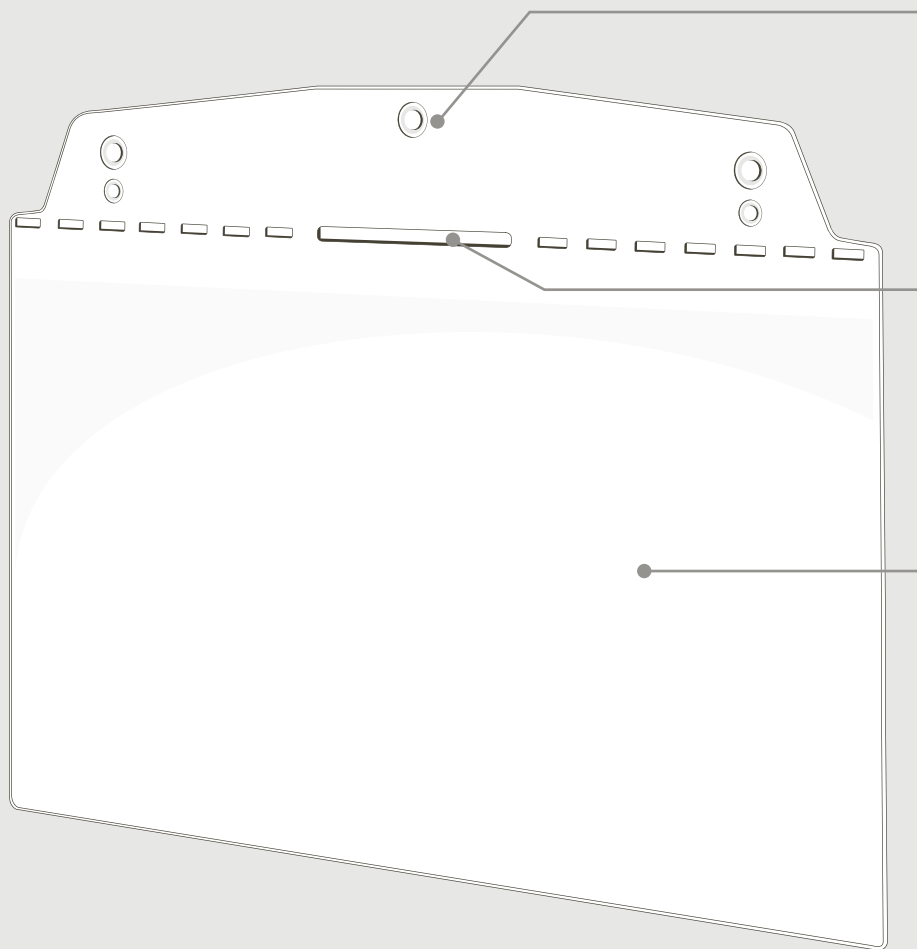

Fori da sospensione per facilitare varie opzioni di fissaggio.

Suspension holes for various fastening fixing options.

Slot stampati per altre opzioni di sospensione e fissaggio

Stamped slots for all-round brackets

**IDP-STAT®
PVC-Hartfolie**

IPD STAT PVC film



Ampia gamma di prodotti
Wide range of products



ESD
Electrostatic discharge



Conforme alla
normativa DIN EN
61340-5-1
*Conforms to the
requirements according to
DIN EN 61340-5-1*

ORGATEX®

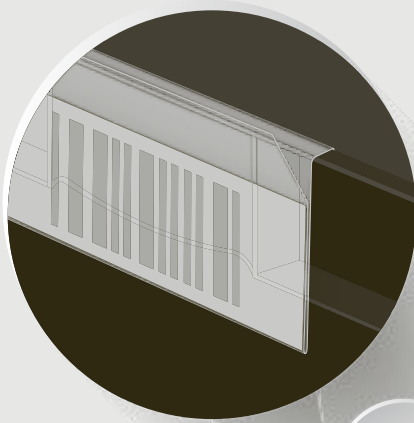

IDP-STAT PELLICOLA PVC

Una speciale pellicola in PVC sviluppata (IDP = Polimero Intrinsecamente Dissipativo) con spessore di 0,25 mm e 0,7 mm. Lo speciale film in PVC consente una conduttività permanente.

IDP STAT PVC Film

A specially developed IDP-STAT PVC film (IDP = Inherently Dissipative Polymer) with a thickness of 0.25 mm and 0.7 mm is used to manufacture our items. The special PVC film enables permanent conductivity.



Formati standard

Standard Format sizes

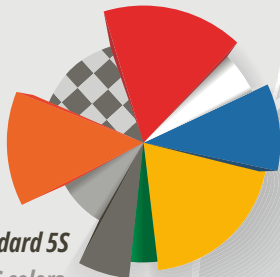

Colori standard 5S
Standard 5S colors



LongLife Segnaletica orizzontale

Il nastro LongLife è l'ideale anche per la segnalazione delle aree ESD.

LongLife floor marking

The floor marking is ideal for marking ESD work areas.



Tecnologia in

continuo sviluppo

Continuous further development

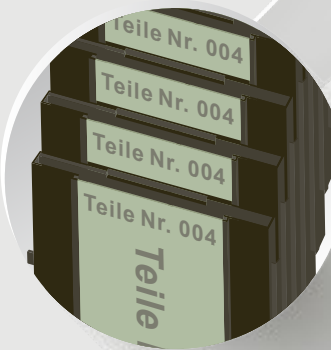

Systembox ESD / Cassette di posta KANBAN ESD

Consente il controllo KANBAN anche in aree sensibili alle scariche elettrostatiche. Systembox e cassette KANBAN sono realizzate in granulato a basso carico (Irgastat P 18 FCA).

System box ESD / KANBAN mailbox ESD

Enables KANBAN control even in ESD-sensitive areas. The system boxes and mailboxes are made from low charging granulate (Irgastat P 18 FCA).

Portadocumenti per sospensione ESD

Hanging3 Visual Pockets ESD

È realizzato in plastica robusta, con una parte superiore rinforzata e una finestra trasparente per gli inserti. La nostra vasta gamma di accessori consente l'etichettatura praticamente su qualsiasi superficie

- Permanentemente conduttivo
- Costituito da un polimero intrinsecamente dissipativo (IDP)
- Soddisfa i requisiti della norma DIN EN 61340-5-1
- Spessore pellicola: 0,25 mm
- Riciclabile
- Può essere scansionato

In many cases, containers offer no suitable surface for labelling. Our overhanging visual pocket can help here. It is made from robust plastic, with a reinforced top section and a transparent window for inserts. Our wide range of accessories allows for labelling on virtually any surface.

- Permanently conductive
- From Inherently Dissipative Polymer (IDP)
- Complies with the requirements of DIN EN 61340-5-1
- Film thickness: 0,25 mm
- Recyclable
- Can be scanned

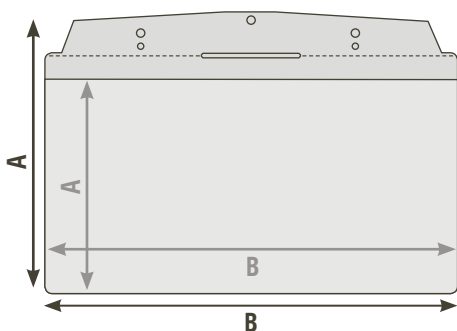

Formati DIN disponibili e dimensioni esterne (mm) / interne (mm)

Existing formats in mm outer dimensions (mm) / inner dimensions (mm)

	1/3	A7 orizz. A7 landsc.	A6 orizz. A6 landsc.	A5 orizz. A5 landsc.	A5 vert. A5 portr.	A4 orizz. A4 landsc.	A4 vert. A4 portr.
A	160 / 108	112 / 70	159 / 111	205 / 152	264 / 217	268 / 217	335 / 328
B	230 / 225	115 / 112	159 / 156	230 / 225	160 / 153	325 / 322	229 / 225



Portadocumenti per sospensione ESD / Hanging Visual Pockets ESD

Formato Format	Cod. Item-No.	+ Colore + Color	Dimensioni est. / int. (LxH) (mm) Inner / outer dim. (WxH) (mm)	Confezione Pack
DIN A7 orizz. / landsc.	SD011-ESD-	01 02 03 04 05 06 07 08 20	115 x 112 / 112 x 70	10 pezzi / pieces
DIN A6 orizz. / landsc.	SD012-ESD-	01 02 03 04 05 06 07 08 20	159 x 159 / 156 x 111	10 pezzi / pieces
1/3 DIN	SD016-ESD-	01 02 03 04 05 06 07 08 20	230 x 160 / 225 x 108	10 pezzi / pieces
DIN A5 orizz. / landsc.	SD013-ESD-	01 02 03 04 05 06 07 08 20	230 x 205 / 225 x 152	10 pezzi / pieces
DIN A5 vert. / portr.	SD015-ESD-	01 02 03 04 05 06 07 08 20	160 x 264 / 153 x 217	10 pezzi / pieces
DIN A4 vert. / portr.	SD018-ESD-	01 02 03 04 05 06 07 08 20	229 x 335 / 225 x 328	10 pezzi / pieces
DIN A4 orizz. / landsc.	SD020-ESD-	01 02 03 04 05 06 07 08 20	325 x 268 / 322 x 217	10 pezzi / pieces



Prodotti ESD / ESD products

Portadocumenti magnetico Neodym ESD / *Magnetic Visual Pockets ESD*

	Formato <i>Format</i>	Cod. <i>Item-No.</i>	+ Colore <i>+ Color</i>	Dimensioni est. / int. (LxH) (mm) <i>Inner / outer dim. (HxW) (mm)</i>	Confezione <i>Pack</i>
	DIN A6 orizz. / <i>landsc.</i>	MU2260-ESD-	01 02 03 04 05 06 07 08 20	159 x 159 / 156 x 111	10 pezzi / <i>pieces</i>
	DIN A6 orizz. / <i>landsc.</i>	MU2250-ESD-	01 02 03 04 05 06 07 08 20	230 x 205 / 225 x 152	10 pezzi / <i>pieces</i>
	1/3 DIN	MU2240-ESD-	01 02 03 04 05 06 07 08 20	229 x 335 / 225 x 328	10 pezzi / <i>pieces</i>
	DIN A5 orizz. / <i>landsc.</i>	MU2230-ESD-	01 02 03 04 05 06 07 08 20	325 x 268 / 322 x 217	10 pezzi / <i>pieces</i>

Kanban cover per sospensione ESD / *Overhang Kanban cover ESD*

	Formato <i>Format</i>	Cod. <i>Item-No.</i>	Dimensione (LxH) (mm) <i>Inner / outer dim. (HxW) (mm)</i>	Confezione <i>Pack</i>
	1/4 DIN	KAN-COW1/4DIN-ESD	215 x 80 X 16	10 pezzi / <i>pieces</i>

KLT snapped ESD / *KLT snapped ESD*

	Cod. <i>Item-No.</i>	Cartoncino <i>Cardboards</i>	Dimensioni est. / int. (LxH) (mm) <i>Inner / outer dim. (HxW) (mm)</i>	Confezione <i>Pack</i>
	KLT-SNAP-ESD-20	ET670	209 x 80 / 200 x 67	50 pezzi / <i>pieces</i>
	KLT-SNAP-1/3DIN-ESD-20	ET85	209 x 99 / 200 x 85	50 pezzi / <i>pieces</i>
	KLT-SNAP-DINA5-20ESD	ET135	209 x 147 / 200 x 135	50 pezzi / <i>pieces</i>

KLT label ESD / *KLT label ESD*

	Cod. <i>Item-No.</i>	Cartoncino <i>Cardboards</i>	Dimensioni est. / int. (LxH) (mm) <i>Inner / outer dim. (HxW) (mm)</i>	Confezione <i>Pack</i>
	KL100-ESD-20	ET670	209 x 74 / 200 x 67	50 pezzi / <i>pieces</i>
	KAN-LABEL1/3DIN-ESD-20	ET85	209 x 99 / 200 x 85	50 pezzi / <i>pieces</i>
	KAN-LABELA5-ESD-20	ET135	209 x 147 / 200 x 135	50 pezzi / <i>pieces</i>

FLIP-MAG ESD / *FLIP-MAG ESD*

	Formato <i>Format</i>	Cod. <i>Item-No.</i>	Dimensioni est. / int. (LxH) (mm) <i>Inner / outer dim. (HxW) (mm)</i>	Confezione <i>Pack</i>
	DIN A4	FLIP-MAG-ESD-20	315 x 255 / 307 x 215	10 pezzi / <i>pieces</i>

Tasca portadocumenti ESD / *Primus ESD*

	Cod. <i>Item-No.</i>	Formato <i>Format</i>	Dimensioni est. / int. (LxH) (mm) <i>Inner / outer dim. (HxW) (mm)</i>	Confezione <i>Pack</i>
	ATP660-ESD-20	DIN A4 vert.	215 x 305 / 210 x 297	10 pezzi / <i>pieces</i>

Systembox ESD / *Systembox ESD*

	Cod. <i>Item-No.</i>	Dimensioni est. / int. (LxHxP) (mm) <i>Inner / outer dim. (HxW) (mm)</i>	Confezione <i>Pack</i>
	SYSB-ESD-06	122 x 192 x 10 / 118 x 190 X 6	10 pezzi / <i>pieces</i>

Accessori systembox ESD / *Accessories systembox ESD*

	Cod. <i>Item-No.</i>	Cartoncino <i>Cardboards</i>	Dimensione (LxH) (mm) <i>Inner / outer dim. (HxW) (mm)</i>	Confezione <i>Pack</i>
	SYSB-HE-35-ESD	ET33-75K	75 x 35	10 pezzi / <i>pieces</i>
	SYSB-HE-169-ESD	ET75-168K	75 x 169	10 pezzi / <i>pieces</i>

Cassette posta in plastica ESD / *Plastic letter box systembox ESD*

	Cod. <i>Item-No.</i>	Dimensione (LxHxP) (mm) <i>Inner / outer dim. (HxW) (mm)</i>	Confezione <i>Pack</i>
	KN-BK-35-ESD-06	115 x 165 x 35	10 pezzi / <i>pieces</i>

LongLife segnaletica orizzontale - simbologia ESD / *LongLife delimitation tape - ESD symbology*

	Cod. <i>Item-No.</i>	Larghezza (mm) <i>Width (mm)</i>	Rotolo <i>Roll</i>
	LG50-ESD	50	50 metri / <i>meters</i>
	LG75-ESD	75	50 metri / <i>meters</i>
	*Attenzione solo simbologia ESD	*Attenzione solo simbologia ESD	



LEANPRODUCTS

Lean manufacturing

LeanProducts srl

Via Bassani, 6-8 | 33170 Pordenone (PN)
T +39 0434 572757 - F +39 0434 572750
info@LeanProducts.eu

www.LeanProducts.eu