

# Tabelle e lavagne informative

Sistema di cornici informative e accessori

New



## Esempio di applicazione

- A: aprire la plastica trasparente ed inserire i fogli
- B: inserire la plastica trasparente nella cornice
- C: bloccare con clip di chiusura
- D: agganciare la cornice con gli accessori adatti

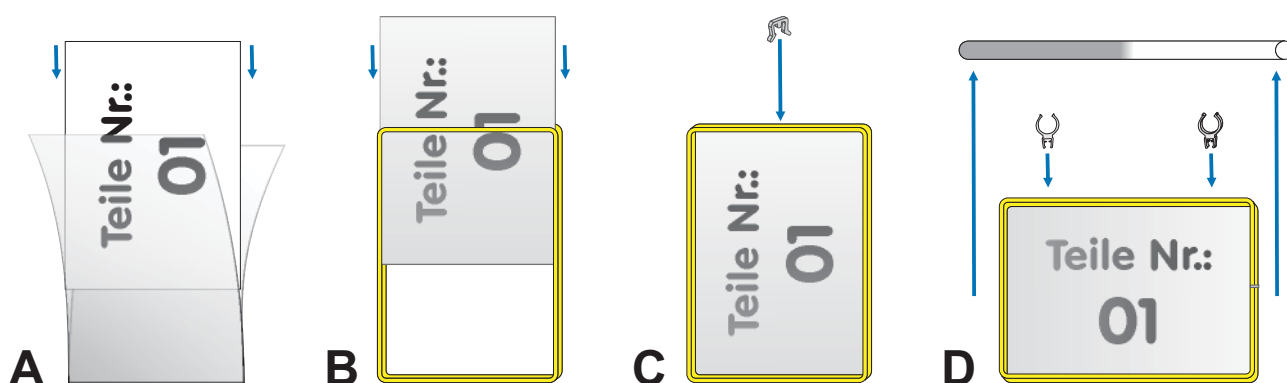

# Sistema di cornici informative e accessori

## Esempio lettura codice a barre

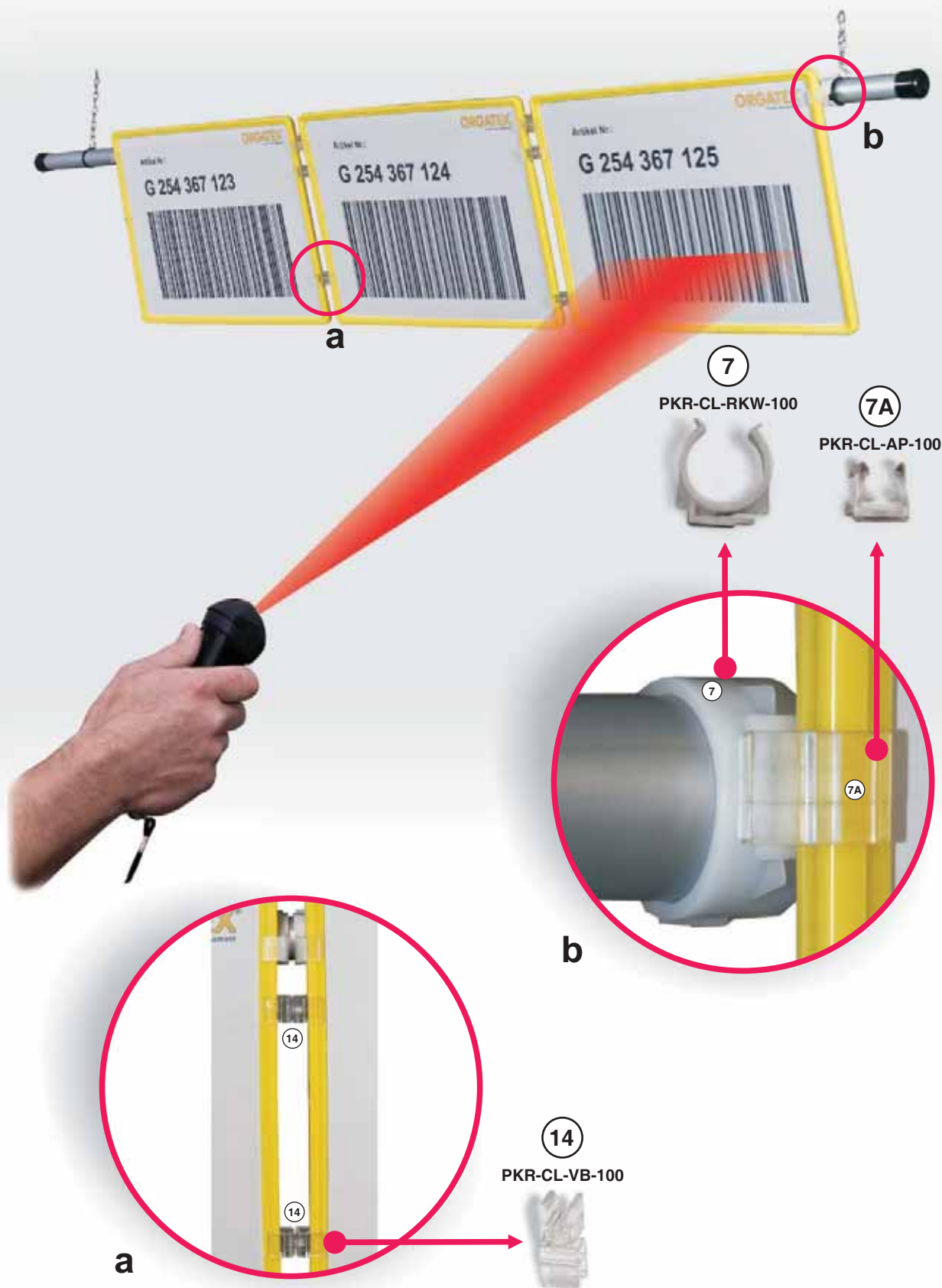

# Table e lavagne informative

Sistema di cornici informative e accessori

Sospensione su tubo

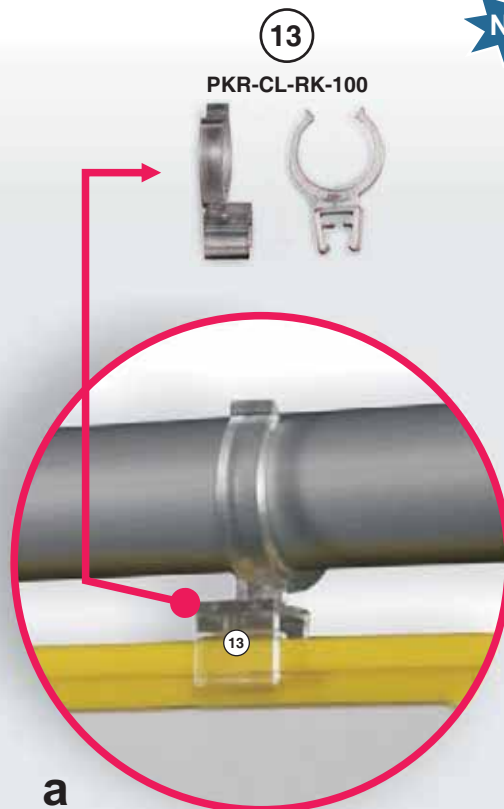

Sospensione con catena metallica

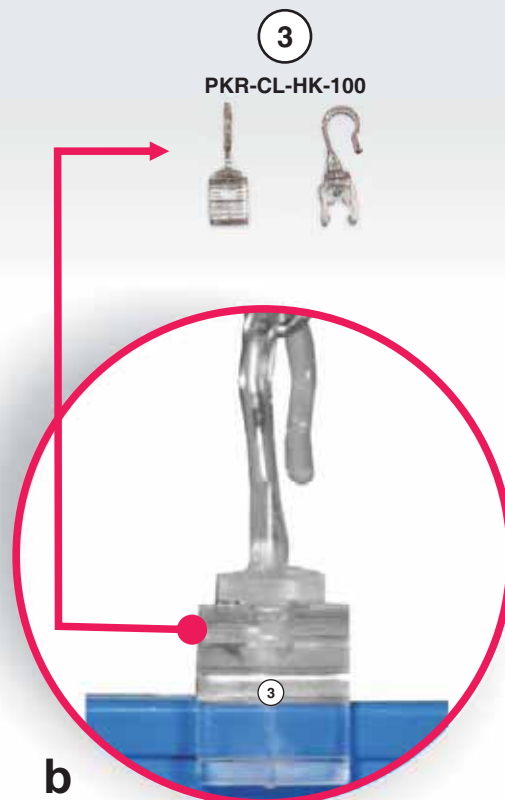
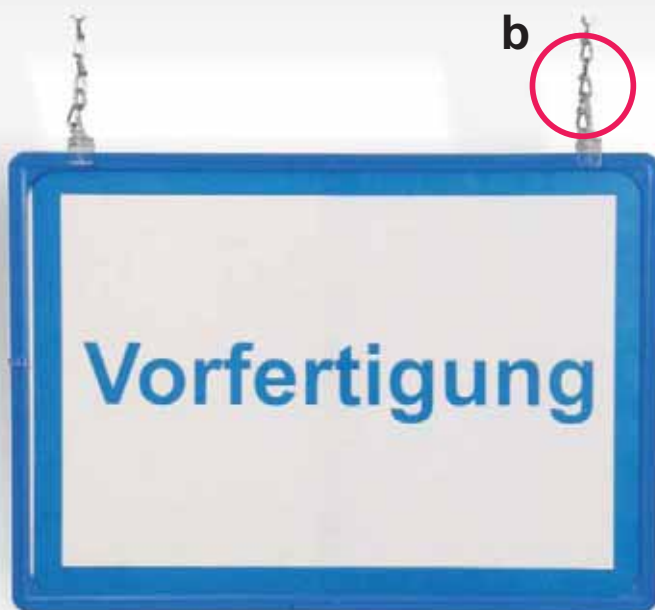

# Sistema di cornici informative e accessori

Esecuzione a cubo

4

PKR-CL-OED-100



a

8

PKR-CL-VA-100

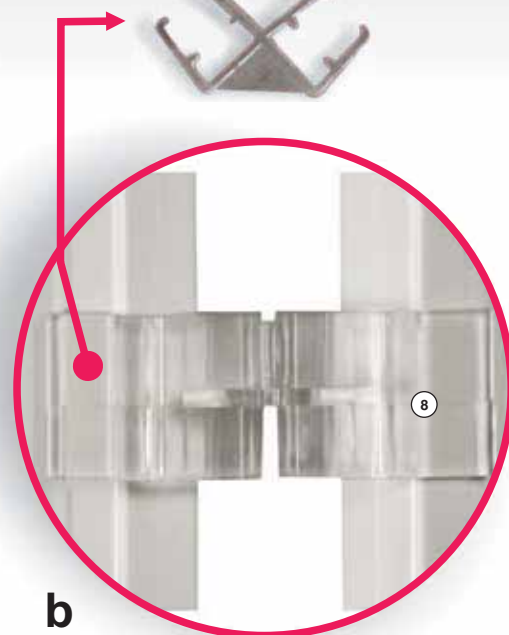

b



# Tabelle e lavagne informative

Sistema di cornici informative e accessori

Esecuzione a triangolo

New

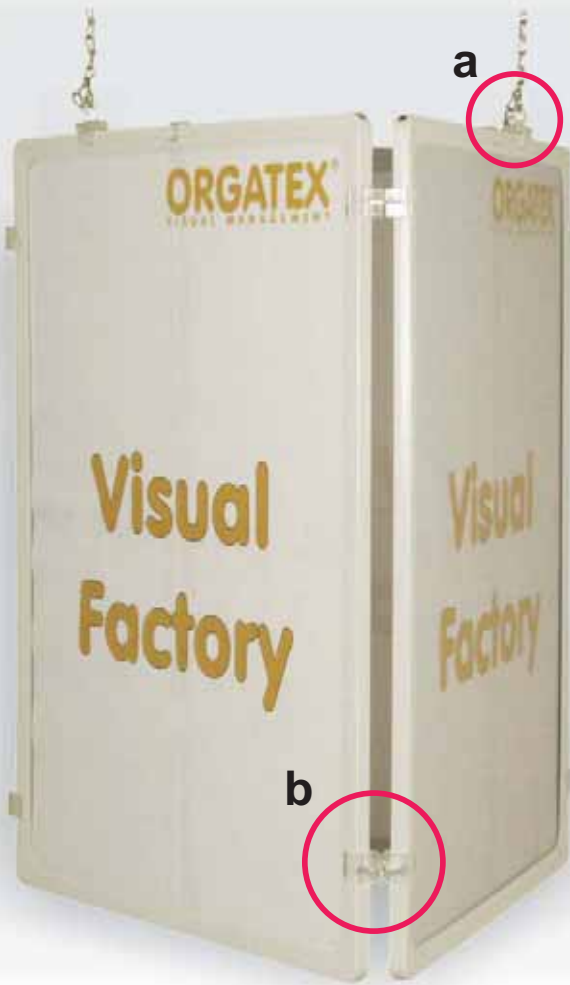

②  
PKR-CL-VS-100

④  
PKR-CL-OED-100

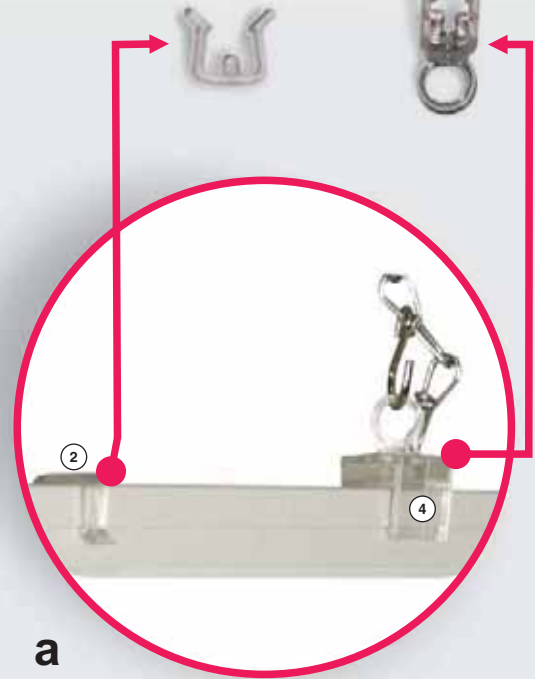

a



⑨  
PKR-CL-DA-100

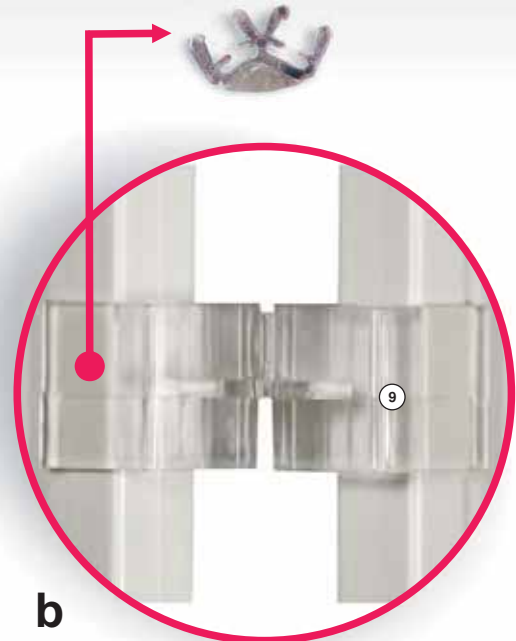

b

# Sistema di cornici informative e accessori

Sospensione con magnete



24  
PKR-DM50-02

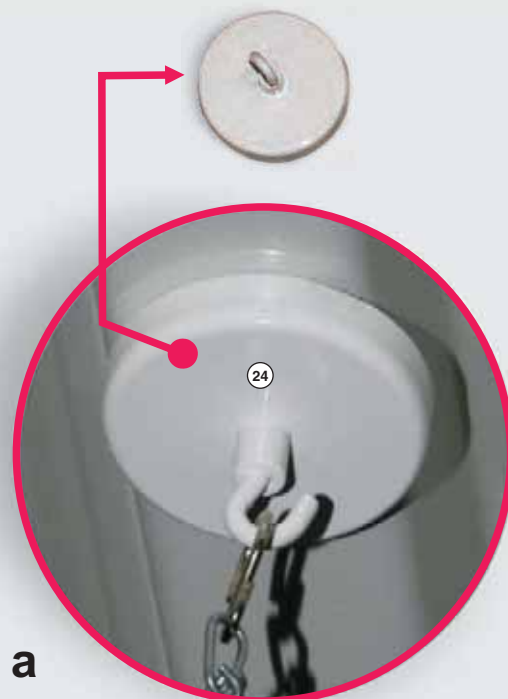

Montaggio a muro

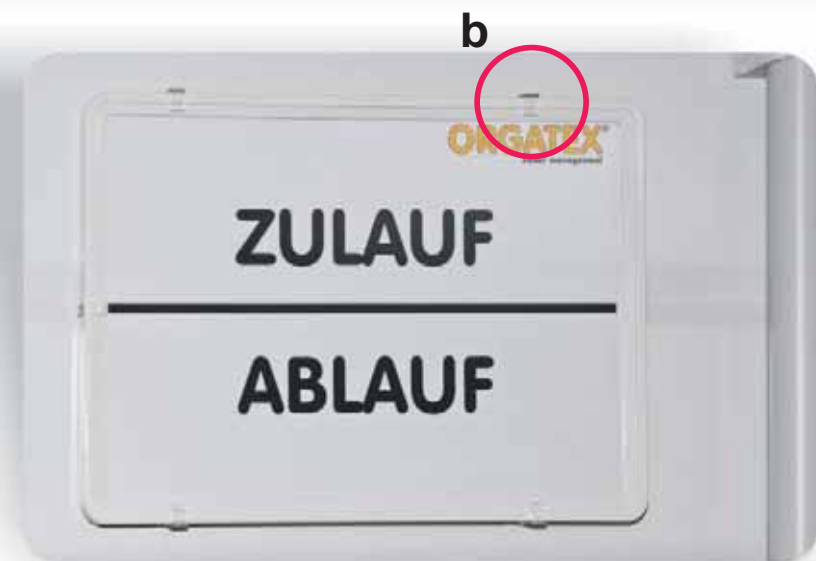

5  
PKR-CL-WH-100



# Tabelle e lavagne informative

Sistema di cornici informative e accessori

Segnaletica per scaffali porta pallet

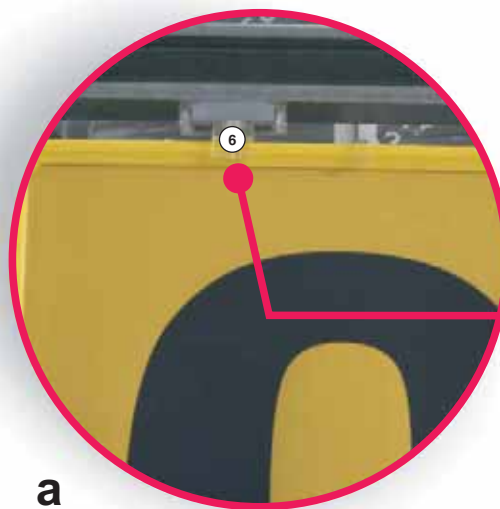

6  
PKR-CL-MAD-100



# Sistema di cornici informative e accessori

## Segnaletica per ceste metalliche

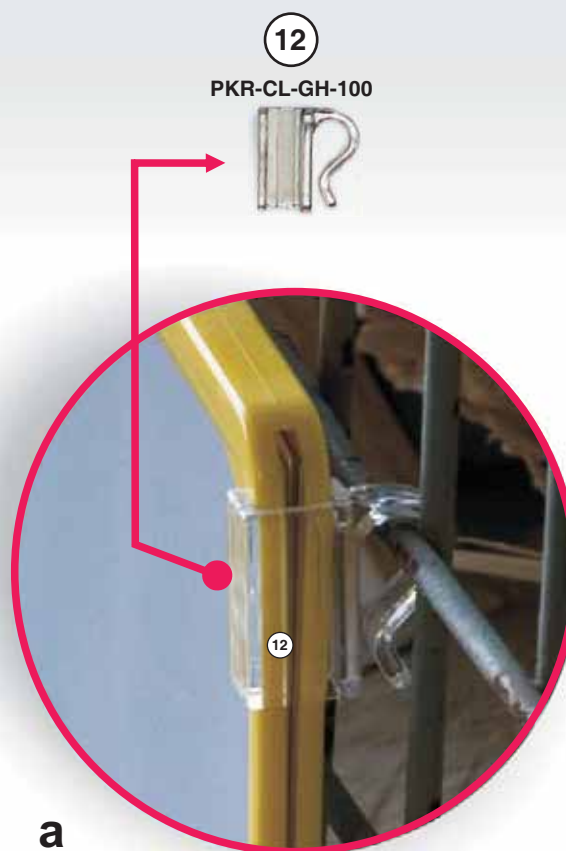

# Tabelle e lavagne informative

Sistema di cornici informative e accessori

Supporto per contenitori abbattibili



(10A) PKR-CL-T60-100      (10) PKR-CH-100



(11) PKR-CL-KK-100



# Sistema di cornici informative e accessori

## Esempio Audit 5S



5S-Sospensione	Codice	Descrizione						
	PKR-5S	5S-Sospensione						
	<b>Confezione = 1 pz.</b>							
<ul style="list-style-type: none"> <li>Set composto da:                             <table border="0" style="width: 100%;"> <tr> <td>1x PKR-R28 (tubo L=2420 mm con 2 tappi neri)</td> <td>6x PKR-CL-RK-100</td> </tr> <tr> <td>3x PKR-A3-100* (con plastica trasp. e clip)</td> <td>6x PKR-CL-OED-100</td> </tr> <tr> <td>3x PKR-A4-100* (con plastica trasp. e clip)</td> <td>6x PKR-CL-HK-100</td> </tr> </table> </li> <li>* Si prega di specificare il colore al momento dell'ordine.</li> <li>Catena metallica non inclusa</li> </ul>			1x PKR-R28 (tubo L=2420 mm con 2 tappi neri)	6x PKR-CL-RK-100	3x PKR-A3-100* (con plastica trasp. e clip)	6x PKR-CL-OED-100	3x PKR-A4-100* (con plastica trasp. e clip)	6x PKR-CL-HK-100
1x PKR-R28 (tubo L=2420 mm con 2 tappi neri)	6x PKR-CL-RK-100							
3x PKR-A3-100* (con plastica trasp. e clip)	6x PKR-CL-OED-100							
3x PKR-A4-100* (con plastica trasp. e clip)	6x PKR-CL-HK-100							

# Tabelle e lavagne informative

Sistema di cornici informative e accessori



## Serie 100

Inclusi



Plastica  
trasparente

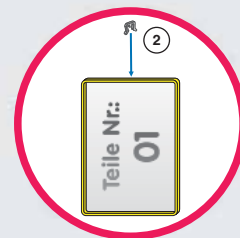

Clip  
chiusura



### Colori disponibili



Cornice S100	Codice (+ Colore)	Codice colore							Descrizione	Formato DIN
		01	02	03	04	05	06	07		
<p>Serie 100</p>	PKR-140-417-100-	-	02	-	-	-	-	-	Cornice S100	140 x 417 mm
	PKR-A5-100-	-	02	-	-	-	06	07	Cornice S100	DIN A5
	PKR-A4-100-	01	02	03	04	05	06	07	Cornice S100	DIN A4
	PKR-A3-100-	01	02	03	04	05	06	07	Cornice S100	DIN A3
<b>Confezione = 5 pz.</b>										
<ul style="list-style-type: none"> <li>• Comprensivo di plastica trasparente antiriflesso e clip di chiusura</li> <li>• Altri colori disponibili su richiesta</li> </ul>										

## Sistema di cornici informative e accessori

Clip di chiusura S100		Codice	Descrizione
 <p>2</p> <p>New</p> <p>Serie 100</p>	PKR-CL-VS-100	Clip di chiusura S100	
	<p>Confezione = 10 pz.</p> <ul style="list-style-type: none"> <li>• Adatto per cornice Serie 100</li> <li>• Plastica trasparente robusta</li> </ul>		

Supporto a gancio S100		Codice	Descrizione
 <p>3</p> <p>New</p> <p>Serie 100</p>	PKR-CL-HK-100	Supporto a gancio S100	
	<p>Confezione = 10 pz.</p> <ul style="list-style-type: none"> <li>• Adatto per cornice Serie 100</li> <li>• Plastica trasparente robusta</li> </ul>		













Supporto ad anello S100		Codice	Descrizione
 <p>4</p> <p>New</p> <p>Serie 100</p>	PKR-CL-OED-100	Supporto ad anello S100	
	<p>Confezione = 10 pz.</p> <ul style="list-style-type: none"> <li>• Adatto per cornice Serie 100</li> <li>• Plastica trasparente robusta</li> </ul>		

Supporto a muro S100		Codice	Descrizione
 <p>5</p> <p>New</p> <p>Serie 100</p> <p>Adesivo</p>	PKR-CL-WH-100	Supporto a muro S100	
	<p>Confezione = 10 pz.</p> <ul style="list-style-type: none"> <li>• Adatto per cornice Serie 100</li> <li>• Supporto a muro con adesivo e fori per fissaggio</li> <li>• Plastica trasparente robusta</li> </ul>		





Supporto magnetico S100		Codice	Descrizione
 <p>6</p> <p>New</p> <p>Serie 100</p> <p>Magnetico</p>	PKR-CL-MAD-100	Supporto magnetico S100	
	<p>Confezione = 10 pz.</p> <ul style="list-style-type: none"> <li>• Adatto per cornice Serie 100</li> <li>• Supporto magnetico girevole (portata 2,5 Kg)</li> <li>• Plastica trasparente robusta</li> </ul>		

# Tabelle e lavagne informative

## Sistema di cornici informative e accessori

<p><b>Supporto per tubo S100</b></p> <p><b>7</b></p> <p><b>New</b></p>  <p>Serie 100</p>	<table border="1"> <thead> <tr> <th>Codice</th> <th>Descrizione</th> </tr> </thead> <tbody> <tr> <td><b>PKR-CL-RKW-100</b></td> <td>Supporto per tubo S100</td> </tr> <tr> <td colspan="2" style="text-align: right;"><b>Confezione = 10 pz.</b></td> </tr> <tr> <td colspan="2"> <ul style="list-style-type: none"> <li>• Adatto per cornice Serie 100</li> <li>• Plastica bianca</li> <li>• Supporto per tubo diametro 23-28 mm</li> <li>• Necessita dell'adattatore PKR-CL-AP-100</li> </ul> </td> </tr> </tbody> </table>	Codice	Descrizione	<b>PKR-CL-RKW-100</b>	Supporto per tubo S100	<b>Confezione = 10 pz.</b>		<ul style="list-style-type: none"> <li>• Adatto per cornice Serie 100</li> <li>• Plastica bianca</li> <li>• Supporto per tubo diametro 23-28 mm</li> <li>• Necessita dell'adattatore PKR-CL-AP-100</li> </ul>	
Codice	Descrizione								
<b>PKR-CL-RKW-100</b>	Supporto per tubo S100								
<b>Confezione = 10 pz.</b>									
<ul style="list-style-type: none"> <li>• Adatto per cornice Serie 100</li> <li>• Plastica bianca</li> <li>• Supporto per tubo diametro 23-28 mm</li> <li>• Necessita dell'adattatore PKR-CL-AP-100</li> </ul>									
<p><b>Adattatore S100</b></p> <p><b>7A</b></p> <p><b>New</b></p>  <p>Serie 100</p>	<table border="1"> <thead> <tr> <th>Codice</th> <th>Descrizione</th> </tr> </thead> <tbody> <tr> <td><b>PKR-CL-AP-100</b></td> <td>Adattatore S100</td> </tr> <tr> <td colspan="2" style="text-align: right;"><b>Confezione = 10 pz.</b></td> </tr> <tr> <td colspan="2"> <ul style="list-style-type: none"> <li>• Adatto per cornice Serie 100</li> <li>• Adattatore per PKR-CL-RKW-100</li> <li>• Plastica trasparente robusta</li> </ul> </td> </tr> </tbody> </table>	Codice	Descrizione	<b>PKR-CL-AP-100</b>	Adattatore S100	<b>Confezione = 10 pz.</b>		<ul style="list-style-type: none"> <li>• Adatto per cornice Serie 100</li> <li>• Adattatore per PKR-CL-RKW-100</li> <li>• Plastica trasparente robusta</li> </ul>	
Codice	Descrizione								
<b>PKR-CL-AP-100</b>	Adattatore S100								
<b>Confezione = 10 pz.</b>									
<ul style="list-style-type: none"> <li>• Adatto per cornice Serie 100</li> <li>• Adattatore per PKR-CL-RKW-100</li> <li>• Plastica trasparente robusta</li> </ul>									
<p><b>Connettore per esecuzione a cubo S100</b></p> <p><b>8</b></p> <p><b>New</b></p>  <p>Serie 100</p>	<table border="1"> <thead> <tr> <th>Codice</th> <th>Descrizione</th> </tr> </thead> <tbody> <tr> <td><b>PKR-CL-VA-100</b></td> <td>Connettore per esecuzione a cubo S100</td> </tr> <tr> <td colspan="2" style="text-align: right;"><b>Confezione = 10 pz.</b></td> </tr> <tr> <td colspan="2"> <ul style="list-style-type: none"> <li>• Adatto per cornice Serie 100</li> <li>• Plastica trasparente robusta</li> <li>• Connettore per esecuzione a cubo</li> </ul>  </td> </tr> </tbody> </table>	Codice	Descrizione	<b>PKR-CL-VA-100</b>	Connettore per esecuzione a cubo S100	<b>Confezione = 10 pz.</b>		<ul style="list-style-type: none"> <li>• Adatto per cornice Serie 100</li> <li>• Plastica trasparente robusta</li> <li>• Connettore per esecuzione a cubo</li> </ul> 	
Codice	Descrizione								
<b>PKR-CL-VA-100</b>	Connettore per esecuzione a cubo S100								
<b>Confezione = 10 pz.</b>									
<ul style="list-style-type: none"> <li>• Adatto per cornice Serie 100</li> <li>• Plastica trasparente robusta</li> <li>• Connettore per esecuzione a cubo</li> </ul> 									
<p><b>Connettore per esecuzione a triangolo S100</b></p> <p><b>9</b></p> <p><b>New</b></p>  <p>Serie 100</p>	<table border="1"> <thead> <tr> <th>Codice</th> <th>Descrizione</th> </tr> </thead> <tbody> <tr> <td><b>PKR-CL-DA-100</b></td> <td>Connettore per esecuzione a triangolo S100</td> </tr> <tr> <td colspan="2" style="text-align: right;"><b>Confezione = 10 pz.</b></td> </tr> <tr> <td colspan="2"> <ul style="list-style-type: none"> <li>• Adatto per cornice Serie 100</li> <li>• Plastica trasparente robusta</li> <li>• Connettore per esecuzione a triangolo</li> </ul>  </td> </tr> </tbody> </table>	Codice	Descrizione	<b>PKR-CL-DA-100</b>	Connettore per esecuzione a triangolo S100	<b>Confezione = 10 pz.</b>		<ul style="list-style-type: none"> <li>• Adatto per cornice Serie 100</li> <li>• Plastica trasparente robusta</li> <li>• Connettore per esecuzione a triangolo</li> </ul> 	
Codice	Descrizione								
<b>PKR-CL-DA-100</b>	Connettore per esecuzione a triangolo S100								
<b>Confezione = 10 pz.</b>									
<ul style="list-style-type: none"> <li>• Adatto per cornice Serie 100</li> <li>• Plastica trasparente robusta</li> <li>• Connettore per esecuzione a triangolo</li> </ul> 									
<p><b>Morsetto S100</b></p> <p><b>10</b></p> <p><b>New</b></p>  <p>Serie 100</p>	<table border="1"> <thead> <tr> <th>Codice</th> <th>Descrizione</th> </tr> </thead> <tbody> <tr> <td><b>PKR-CH-100</b></td> <td>Morsetto S100</td> </tr> <tr> <td colspan="2" style="text-align: right;"><b>Confezione = 20 pz.</b></td> </tr> <tr> <td colspan="2"> <ul style="list-style-type: none"> <li>• Adatto per cornice Serie 100</li> <li>• Morsetto per supporto a T adatto per tubi, contenitori, ecc.</li> </ul> </td> </tr> </tbody> </table>	Codice	Descrizione	<b>PKR-CH-100</b>	Morsetto S100	<b>Confezione = 20 pz.</b>		<ul style="list-style-type: none"> <li>• Adatto per cornice Serie 100</li> <li>• Morsetto per supporto a T adatto per tubi, contenitori, ecc.</li> </ul>	
Codice	Descrizione								
<b>PKR-CH-100</b>	Morsetto S100								
<b>Confezione = 20 pz.</b>									
<ul style="list-style-type: none"> <li>• Adatto per cornice Serie 100</li> <li>• Morsetto per supporto a T adatto per tubi, contenitori, ecc.</li> </ul>									
<p><b>Supporto a T S100</b></p> <p><b>10A</b></p> <p><b>New</b></p>  <p>Serie 100</p>	<table border="1"> <thead> <tr> <th>Codice</th> <th>Descrizione</th> </tr> </thead> <tbody> <tr> <td><b>PKR-CL-T60-100</b></td> <td>Supporto a T S100</td> </tr> <tr> <td colspan="2" style="text-align: right;"><b>Confezione = 20 pz.</b></td> </tr> <tr> <td colspan="2"> <ul style="list-style-type: none"> <li>• Adatto per cornice Serie 100</li> <li>• Supporto a T da utilizzare in complemento al morsetto PKR-CH-100</li> </ul> </td> </tr> </tbody> </table>	Codice	Descrizione	<b>PKR-CL-T60-100</b>	Supporto a T S100	<b>Confezione = 20 pz.</b>		<ul style="list-style-type: none"> <li>• Adatto per cornice Serie 100</li> <li>• Supporto a T da utilizzare in complemento al morsetto PKR-CH-100</li> </ul>	
Codice	Descrizione								
<b>PKR-CL-T60-100</b>	Supporto a T S100								
<b>Confezione = 20 pz.</b>									
<ul style="list-style-type: none"> <li>• Adatto per cornice Serie 100</li> <li>• Supporto a T da utilizzare in complemento al morsetto PKR-CH-100</li> </ul>									

## Sistema di cornici informative e accessori

<p><b>Supporto ad inserimento S100</b></p> <p><b>11</b></p> <p>New</p>  <p>Serie 100</p>	<table border="1"> <thead> <tr> <th>Codice</th> <th>Descrizione</th> </tr> </thead> <tbody> <tr> <td>PKR-CL-KK-100</td> <td>Supporto ad inserimento S100</td> </tr> <tr> <td colspan="2" style="text-align: right;"><b>Confezione = 10 pz.</b></td> </tr> <tr> <td colspan="2"> <ul style="list-style-type: none"> <li>• Adatto per cornice Serie 100</li> <li>• Supporto ad inserimento fino a 20 mm di spessore</li> <li>• Plastica trasparente robusta</li> </ul> </td> </tr> </tbody> </table>	Codice	Descrizione	PKR-CL-KK-100	Supporto ad inserimento S100	<b>Confezione = 10 pz.</b>		<ul style="list-style-type: none"> <li>• Adatto per cornice Serie 100</li> <li>• Supporto ad inserimento fino a 20 mm di spessore</li> <li>• Plastica trasparente robusta</li> </ul>	
Codice	Descrizione								
PKR-CL-KK-100	Supporto ad inserimento S100								
<b>Confezione = 10 pz.</b>									
<ul style="list-style-type: none"> <li>• Adatto per cornice Serie 100</li> <li>• Supporto ad inserimento fino a 20 mm di spessore</li> <li>• Plastica trasparente robusta</li> </ul>									
<p><b>Supporto per ceste metalliche S100</b></p> <p><b>12</b></p> <p>New</p>  <p>Serie 100</p>	<table border="1"> <thead> <tr> <th>Codice</th> <th>Descrizione</th> </tr> </thead> <tbody> <tr> <td>PKR-CL-GH-100</td> <td>Supporto per ceste metalliche S100</td> </tr> <tr> <td colspan="2" style="text-align: right;"><b>Confezione = 10 coppie (sinistro+destra)</b></td> </tr> <tr> <td colspan="2"> <ul style="list-style-type: none"> <li>• Adatto per cornice Serie 100</li> <li>• Supporto per ceste metalliche con filo 10 mm di spessore</li> <li>• Plastica trasparente robusta</li> </ul> </td> </tr> </tbody> </table>	Codice	Descrizione	PKR-CL-GH-100	Supporto per ceste metalliche S100	<b>Confezione = 10 coppie (sinistro+destra)</b>		<ul style="list-style-type: none"> <li>• Adatto per cornice Serie 100</li> <li>• Supporto per ceste metalliche con filo 10 mm di spessore</li> <li>• Plastica trasparente robusta</li> </ul>	
Codice	Descrizione								
PKR-CL-GH-100	Supporto per ceste metalliche S100								
<b>Confezione = 10 coppie (sinistro+destra)</b>									
<ul style="list-style-type: none"> <li>• Adatto per cornice Serie 100</li> <li>• Supporto per ceste metalliche con filo 10 mm di spessore</li> <li>• Plastica trasparente robusta</li> </ul>									
<p><b>Supporto rotondo S100</b></p> <p><b>13</b></p> <p>New</p>  <p>Serie 100</p>	<table border="1"> <thead> <tr> <th>Codice</th> <th>Descrizione</th> </tr> </thead> <tbody> <tr> <td>PKR-CL-RK-100</td> <td>Supporto rotondo S100</td> </tr> <tr> <td colspan="2" style="text-align: right;"><b>Confezione = 10 pz.</b></td> </tr> <tr> <td colspan="2"> <ul style="list-style-type: none"> <li>• Adatto per cornice Serie 100</li> <li>• Supporto rotondo per tubo diametro 28-35 mm</li> <li>• Plastica trasparente robusta</li> </ul> </td> </tr> </tbody> </table>	Codice	Descrizione	PKR-CL-RK-100	Supporto rotondo S100	<b>Confezione = 10 pz.</b>		<ul style="list-style-type: none"> <li>• Adatto per cornice Serie 100</li> <li>• Supporto rotondo per tubo diametro 28-35 mm</li> <li>• Plastica trasparente robusta</li> </ul>	
Codice	Descrizione								
PKR-CL-RK-100	Supporto rotondo S100								
<b>Confezione = 10 pz.</b>									
<ul style="list-style-type: none"> <li>• Adatto per cornice Serie 100</li> <li>• Supporto rotondo per tubo diametro 28-35 mm</li> <li>• Plastica trasparente robusta</li> </ul>									
<p><b>Connettore girevole S100</b></p> <p><b>14</b></p> <p>New</p>  <p>Serie 100</p>	<table border="1"> <thead> <tr> <th>Codice</th> <th>Descrizione</th> </tr> </thead> <tbody> <tr> <td>PKR-CL-VB-100</td> <td>Connettore girevole S100</td> </tr> <tr> <td colspan="2" style="text-align: right;"><b>Confezione = 10 pz.</b></td> </tr> <tr> <td colspan="2"> <ul style="list-style-type: none"> <li>• Adatto per cornice Serie 100</li> <li>• Connettore girevole per cornici Serie 100</li> <li>• Plastica trasparente robusta</li> </ul> </td> </tr> </tbody> </table>	Codice	Descrizione	PKR-CL-VB-100	Connettore girevole S100	<b>Confezione = 10 pz.</b>		<ul style="list-style-type: none"> <li>• Adatto per cornice Serie 100</li> <li>• Connettore girevole per cornici Serie 100</li> <li>• Plastica trasparente robusta</li> </ul>	
Codice	Descrizione								
PKR-CL-VB-100	Connettore girevole S100								
<b>Confezione = 10 pz.</b>									
<ul style="list-style-type: none"> <li>• Adatto per cornice Serie 100</li> <li>• Connettore girevole per cornici Serie 100</li> <li>• Plastica trasparente robusta</li> </ul>									
<p><b>Supporto girevole S100</b></p> <p><b>15</b></p> <p>New</p>  <p>Serie 100</p>	<table border="1"> <thead> <tr> <th>Codice</th> <th>Descrizione</th> </tr> </thead> <tbody> <tr> <td>PKR-CL-SHD-100</td> <td>Supporto girevole S100</td> </tr> <tr> <td colspan="2" style="text-align: right;"><b>Confezione = 10 pz.</b></td> </tr> <tr> <td colspan="2"> <ul style="list-style-type: none"> <li>• Adatto per cornice Serie 100</li> <li>• Supporto girevole con fissaggio con viti</li> <li>• Plastica trasparente robusta</li> </ul> </td> </tr> </tbody> </table>	Codice	Descrizione	PKR-CL-SHD-100	Supporto girevole S100	<b>Confezione = 10 pz.</b>		<ul style="list-style-type: none"> <li>• Adatto per cornice Serie 100</li> <li>• Supporto girevole con fissaggio con viti</li> <li>• Plastica trasparente robusta</li> </ul>	
Codice	Descrizione								
PKR-CL-SHD-100	Supporto girevole S100								
<b>Confezione = 10 pz.</b>									
<ul style="list-style-type: none"> <li>• Adatto per cornice Serie 100</li> <li>• Supporto girevole con fissaggio con viti</li> <li>• Plastica trasparente robusta</li> </ul>									

# Tabelle e lavagne informative

Sistema di cornici informative e accessori



## Serie 200

Inclusi

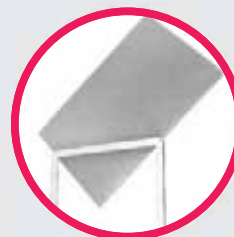

Plastica  
trasparente

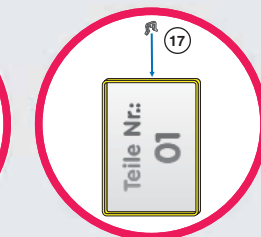

Clip  
chiusura



### Colori disponibili

07

Grigio

#### Cornice S200

16



Serie 200

Codice (+ Colore)	Codice colore	Descrizione	Formato
-------------------	---------------	-------------	---------

01 02 03 04 05 06 07

PKR-A2-200-	- - - - - 07	Cornice S200	DIN A2
PKR-A1-200-	- - - - - 07	Cornice S200	DIN A1

Confezione = 5 pz.

• Comprensivo di plastica trasparente antiriflesso e clip di chiusura

#### Clip di chiusura S200

17



Serie 200





Codice (+ Colore)	Descrizione
-------------------	-------------

PKR-CL-VS-200	Clip di chiusura S200
---------------	-----------------------

Confezione = 10 pz.

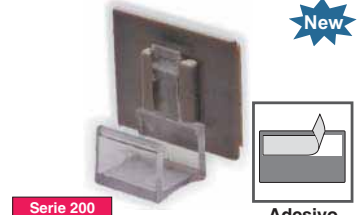

• Adatto per cornice Serie 200  
• Plastica trasparente robusta



## Sistema di cornici informative e accessori



<p><b>Supporto ad anello S200</b> <span style="border: 1px solid black; border-radius: 50%; padding: 2px;">18</span></p>  <p style="text-align: right;"><b>New</b></p> <p style="text-align: left;">Serie 200</p>	<table border="1"> <thead> <tr> <th style="width: 30%;">Codice (+ Colore)</th> <th>Descrizione</th> </tr> </thead> <tbody> <tr> <td>PKR-CL-OED-200</td> <td>Supporto ad anello S200</td> </tr> <tr> <td colspan="2" style="text-align: right;"><b>Confezione = 10 pz.</b></td> </tr> <tr> <td colspan="2"> <ul style="list-style-type: none"> <li>• Adatto per cornice Serie 200</li> <li>• Plastica trasparente robusta</li> </ul> </td> </tr> </tbody> </table>	Codice (+ Colore)	Descrizione	PKR-CL-OED-200	Supporto ad anello S200	<b>Confezione = 10 pz.</b>		<ul style="list-style-type: none"> <li>• Adatto per cornice Serie 200</li> <li>• Plastica trasparente robusta</li> </ul>	
Codice (+ Colore)	Descrizione								
PKR-CL-OED-200	Supporto ad anello S200								
<b>Confezione = 10 pz.</b>									
<ul style="list-style-type: none"> <li>• Adatto per cornice Serie 200</li> <li>• Plastica trasparente robusta</li> </ul>									
<p><b>Supporto magnetico S200</b> <span style="border: 1px solid black; border-radius: 50%; padding: 2px;">19</span></p>  <p style="text-align: right;"><b>New</b></p> <p style="text-align: left;">Serie 200</p> <p style="text-align: center;">Magnetico</p>	<table border="1"> <thead> <tr> <th style="width: 30%;">Codice</th> <th>Descrizione</th> </tr> </thead> <tbody> <tr> <td>PKR-CL-MAD-200</td> <td>Supporto magnetico S200</td> </tr> <tr> <td colspan="2" style="text-align: right;"><b>Confezione = 10 pz.</b></td> </tr> <tr> <td colspan="2"> <ul style="list-style-type: none"> <li>• Adatto per cornice Serie 200</li> <li>• Supporto magnetico girevole (portata 2,5 Kg)</li> <li>• Plastica trasparente robusta</li> </ul> </td> </tr> </tbody> </table>	Codice	Descrizione	PKR-CL-MAD-200	Supporto magnetico S200	<b>Confezione = 10 pz.</b>		<ul style="list-style-type: none"> <li>• Adatto per cornice Serie 200</li> <li>• Supporto magnetico girevole (portata 2,5 Kg)</li> <li>• Plastica trasparente robusta</li> </ul>	
Codice	Descrizione								
PKR-CL-MAD-200	Supporto magnetico S200								
<b>Confezione = 10 pz.</b>									
<ul style="list-style-type: none"> <li>• Adatto per cornice Serie 200</li> <li>• Supporto magnetico girevole (portata 2,5 Kg)</li> <li>• Plastica trasparente robusta</li> </ul>									
<p><b>Supporto a muro S200</b> <span style="border: 1px solid black; border-radius: 50%; padding: 2px;">20</span></p>  <p style="text-align: right;"><b>New</b></p> <p style="text-align: left;">Serie 200</p> <p style="text-align: center;">Adesivo</p>	<table border="1"> <thead> <tr> <th style="width: 30%;">Codice</th> <th>Descrizione</th> </tr> </thead> <tbody> <tr> <td>PKR-CL-WH-200</td> <td>Supporto a muro S200</td> </tr> <tr> <td colspan="2" style="text-align: right;"><b>Confezione = 10 pz.</b></td> </tr> <tr> <td colspan="2"> <ul style="list-style-type: none"> <li>• Adatto per cornice Serie 200</li> <li>• Supporto a muro con adesivo</li> <li>• Plastica trasparente robusta</li> </ul> </td> </tr> </tbody> </table>	Codice	Descrizione	PKR-CL-WH-200	Supporto a muro S200	<b>Confezione = 10 pz.</b>		<ul style="list-style-type: none"> <li>• Adatto per cornice Serie 200</li> <li>• Supporto a muro con adesivo</li> <li>• Plastica trasparente robusta</li> </ul>	
Codice	Descrizione								
PKR-CL-WH-200	Supporto a muro S200								
<b>Confezione = 10 pz.</b>									
<ul style="list-style-type: none"> <li>• Adatto per cornice Serie 200</li> <li>• Supporto a muro con adesivo</li> <li>• Plastica trasparente robusta</li> </ul>									
<p><b>Supporto girevole S200</b> <span style="border: 1px solid black; border-radius: 50%; padding: 2px;">21</span></p>  <p style="text-align: right;"><b>New</b></p> <p style="text-align: left;">Serie 200</p>	<table border="1"> <thead> <tr> <th style="width: 30%;">Codice</th> <th>Descrizione</th> </tr> </thead> <tbody> <tr> <td>PKR-CL-SHD-200</td> <td>Supporto girevole S200</td> </tr> <tr> <td colspan="2" style="text-align: right;"><b>Confezione = 10 pz.</b></td> </tr> <tr> <td colspan="2"> <ul style="list-style-type: none"> <li>• Adatto per cornice Serie 200</li> <li>• Supporto girevole con fissaggio con viti</li> <li>• Plastica trasparente robusta</li> </ul> </td> </tr> </tbody> </table>	Codice	Descrizione	PKR-CL-SHD-200	Supporto girevole S200	<b>Confezione = 10 pz.</b>		<ul style="list-style-type: none"> <li>• Adatto per cornice Serie 200</li> <li>• Supporto girevole con fissaggio con viti</li> <li>• Plastica trasparente robusta</li> </ul>	
Codice	Descrizione								
PKR-CL-SHD-200	Supporto girevole S200								
<b>Confezione = 10 pz.</b>									
<ul style="list-style-type: none"> <li>• Adatto per cornice Serie 200</li> <li>• Supporto girevole con fissaggio con viti</li> <li>• Plastica trasparente robusta</li> </ul>									
<p><b>Connettore S200</b> <span style="border: 1px solid black; border-radius: 50%; padding: 2px;">22</span></p>  <p style="text-align: right;"><b>New</b></p> <p style="text-align: left;">Serie 200</p>	<table border="1"> <thead> <tr> <th style="width: 30%;">Codice</th> <th>Descrizione</th> </tr> </thead> <tbody> <tr> <td>PKR-CL-FS-200</td> <td>Connettore S200</td> </tr> <tr> <td colspan="2" style="text-align: right;"><b>Confezione = 10 pz.</b></td> </tr> <tr> <td colspan="2"> <ul style="list-style-type: none"> <li>• Adatto per cornice Serie 200</li> <li>• Plastica trasparente robusta</li> <li>• Connettore per esecuzione a cubo o a triangolo per cornici Serie 200 (DIN A1, DIN A2)</li> </ul> </td> </tr> </tbody> </table>	Codice	Descrizione	PKR-CL-FS-200	Connettore S200	<b>Confezione = 10 pz.</b>		<ul style="list-style-type: none"> <li>• Adatto per cornice Serie 200</li> <li>• Plastica trasparente robusta</li> <li>• Connettore per esecuzione a cubo o a triangolo per cornici Serie 200 (DIN A1, DIN A2)</li> </ul>	
Codice	Descrizione								
PKR-CL-FS-200	Connettore S200								
<b>Confezione = 10 pz.</b>									
<ul style="list-style-type: none"> <li>• Adatto per cornice Serie 200</li> <li>• Plastica trasparente robusta</li> <li>• Connettore per esecuzione a cubo o a triangolo per cornici Serie 200 (DIN A1, DIN A2)</li> </ul>									



# Tabelle e lavagne informative

## Sistema di cornici informative e accessori

Aggancio a S		Codice (+ Colore)	Descrizione
	<b>23</b> 	PKR-SHK	Aggancio a S
		<b>Confezione = 10 pz.</b>	
<ul style="list-style-type: none"> <li>• Materiale: metallo</li> <li>• Aggancio a S per catena metallica</li> </ul>			

Magnete con aggancio		Codice	Descrizione
	<b>24</b> 	PKR-DM50-02	Magnete con aggancio
		<b>Confezione = 1 pz.</b>	
<ul style="list-style-type: none"> <li>• Magnete con aggancio, portata 12 Kg</li> </ul>			

Supporto per soffitti		Codice	Descrizione
	<b>25</b> 	PKR-DK	Supporto per soffitti
		<b>Confezione = 10 pz.</b>	
<ul style="list-style-type: none"> <li>• Supporto per soffitti con innesto da 4 mm</li> </ul>			

Catena metallica		Codice	Descrizione
	<b>26</b> 	PKR-KK	Catena metallica
		<b>Confezione = 30 m</b>	
<ul style="list-style-type: none"> <li>• Catena metallica per sospendere le cornici</li> </ul>			

Tubo L=2420 mm		Codice	Descrizione
	<b>27</b> 	PKR-R28	Tubo L=2420 mm
		<b>Confezione = 1 pz.</b>	
<ul style="list-style-type: none"> <li>• Tubo metallico ricoperto in PVC grigio con inclusi 2 tappi in PVC nero</li> <li>• Lunghezza 2420 mm</li> </ul>			





**Quick Label: SL067-300** (28)  
(67 x 300 mm)

vedi pag. 40

**LongLife - Schermo protettivo** (29)

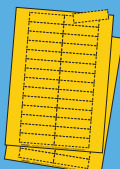
vedi pag. 89

**Cartoncino giallo** (30)  

Codice	Dimensioni A x L (mm)	N° cartoncini per foglio	N° fogli per confezione
ET800-04	67 x 300	su richiesta	
ETA4-04	DIN A4	1	10
ETA3-04	DIN A3	1	10

**Confezioni varie**

# Tabelle e lavagne informative

Prodotti per magazzini



Flexschild

31



vedi pag. 70

Cartoncino giallo

32

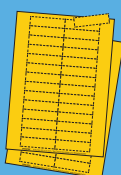

Codice	Formato DIN	N° cartoncini per foglio	N° fogli per confezione
ETA4-04	DIN A4	1	10
ETA3-04	DIN A3	1	10

**LEANPRODUCTS®**

by

**tecnogroup**  
componenti e sistemi per l'automazione



Tel. +39 0434 572757 • Fax. +39 0434 572750  
info@LeanProducts.eu • www.LeanProducts.eu