

Floor marking



Floor marking

- LongLife FloorMarking
- LongLife - 45° and 90° angles
- LongLife - Marking symbols
- LongLife Rounded - Marking symbols

Pages 74-87



Floor marking

- LongLife - Protective screen
- Path and area classification symbols
- LongLife - Numbers and letters

Pages 88-93



Plastic plates

- LongLife MODUL

Pages 94-95

Floor marking

Floor marking



LongLife FloorMarking® program is specific for production areas delimitation. Available sizes and colors allow a quick implementation of **Lean Visual Management** reducing waste.

Features:

- long durability
- immediate application and removal
- washing and abrasion resistant
- not ruin the floor
- constant color
- anti-slip treating
- solvent-free



LongLife FloorMarking →

Test independently made by an English company of automotive sector: ORGATEX LongLife FloorMarking compared with competitors tapes

Tips on using color

Main area

Format: roll
Color: yellow
Width: 75 or 100 mm

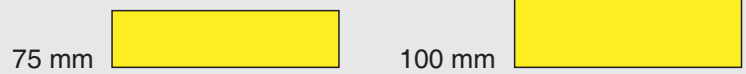

End product

Format: symbols
Color: green
Width: 50 or 75 mm



Processing material

Format: symbols
Color: blue
Width: 50 or 75 mm

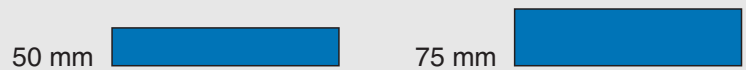

Not standard material

Format: symbols
Color: red
Width: 50 or 75 mm

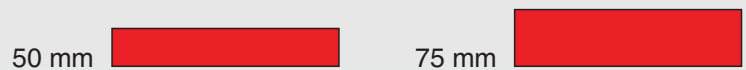

Danger zone

Format: roll
Color: yellow/black
Width: 50 or 75 mm



Empty containers area

Format: roll
Color: white/blue
Width: 50 or 75 mm



Various areas (dolly position, tools, ecc.)

Format: roll or symbols
Color: white
Width: 50 or 75 mm



Floor marking

Application examples

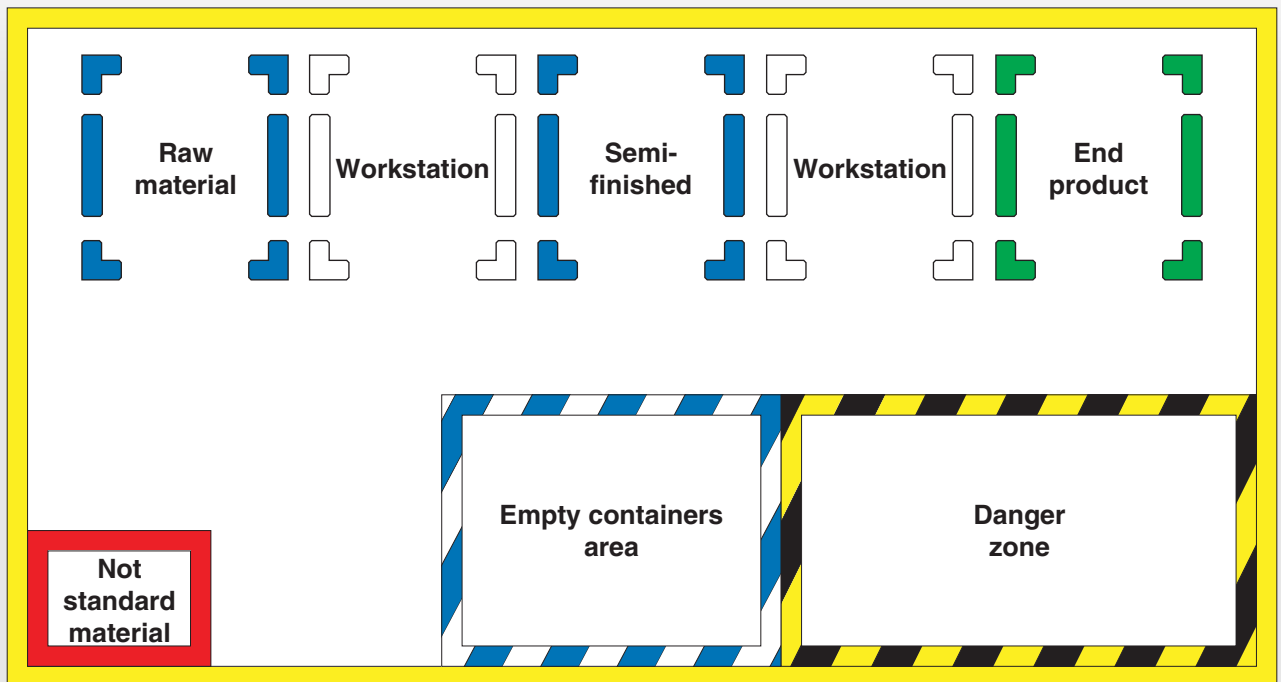

Tips

Not include more than two levels.

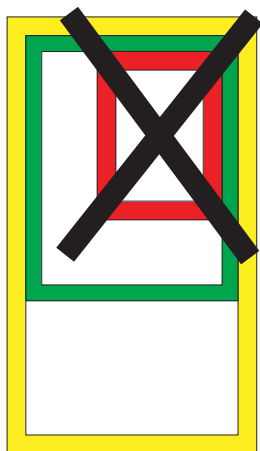

Leave an empty space of 30 - 50 mm around the position to delimitate.

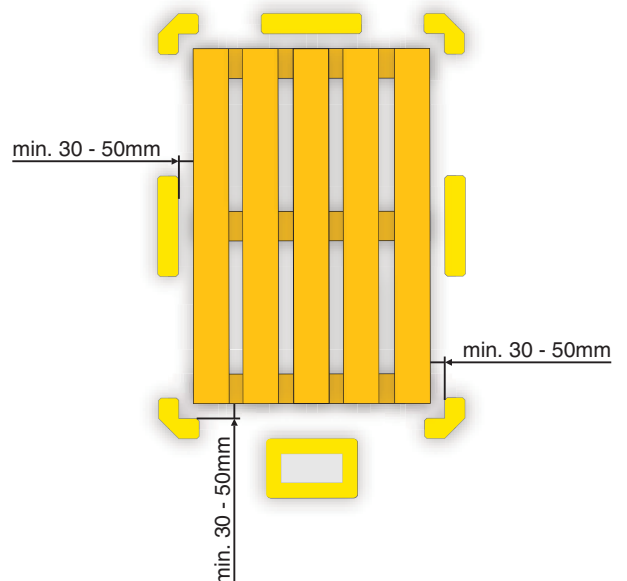

Application examples



Floor marking

Application tips



Surface clean and dry / free of dirt, grease and solvent

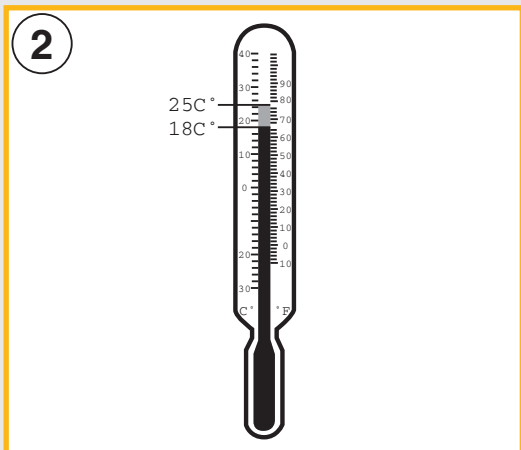

Ideal usage temperature



To cure about 12 hours

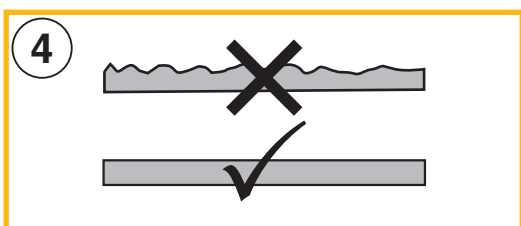

Surface as few pock marks or holes as possible



Do not overlap LongLife FloorMarkings!

Different parameters such as temperature, humidity and the condition of the floor surface itself (4) can effect the quality of LongLife products features.

(1) The surface has to be dry and clean. Dust, grease, oil and solvents have to be removed before application. It is recommended to use alcohol or white spirit for the cleaning of the surface. Peeling paint should either be removed or repaired.

(2) The recommended temperature for fixing LongLife products is between +18°C and 25°C. At lower temperatures, the optimal adhesion process will take longer.

(3) Wait about 12 hours after application before you stress the product.

(5) Do not overlap more LongLife strips to ensure better adhesion and durability of the product.

LongLife has been developed and tested for its use as floor marking. We recommend that you test the samples in order to assess that they correspond to your requirements. All recommendations and information for the use of LongLife are based on our working experience, they are given to the best of our knowledge and without guarantee.

Application tips

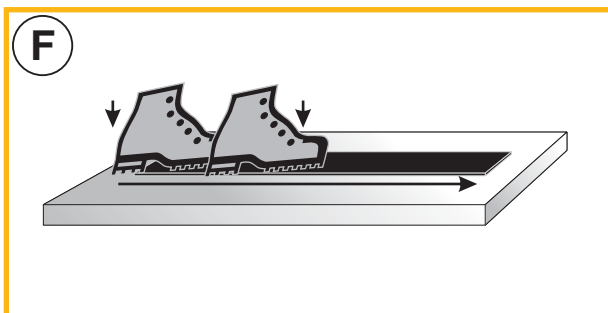
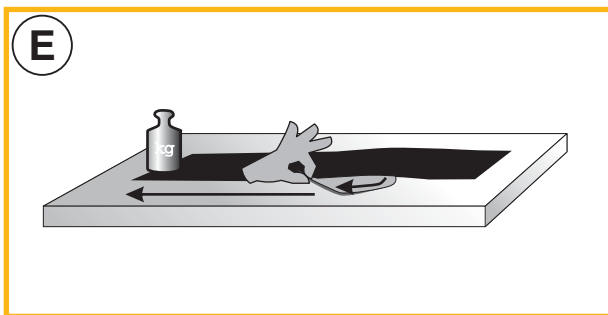
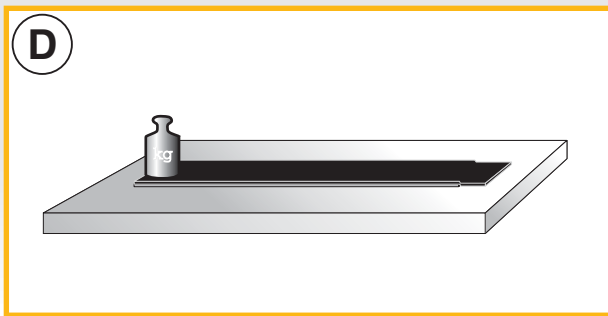
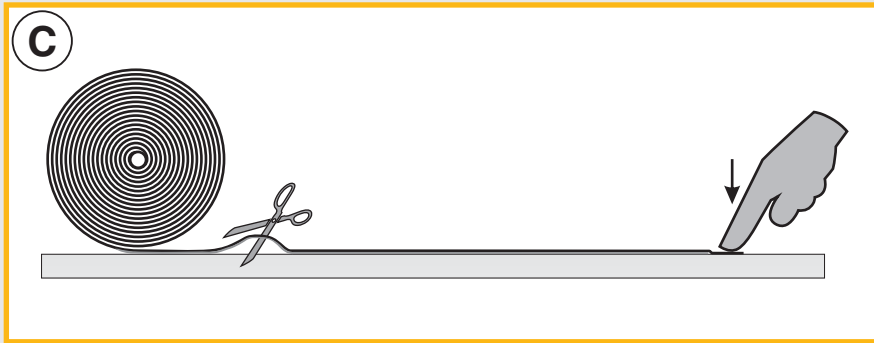
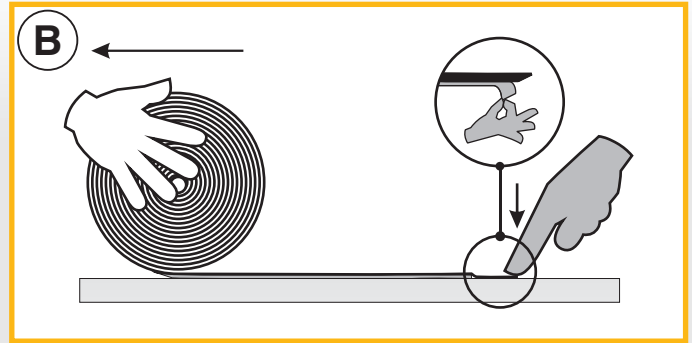

Floor marking

LongLife FloorMarking



Longlife FloorMarking:
easy and fast application.
Remove paper support.
Press on - Done!

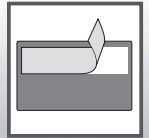

Self-adhesive



Easy to customize

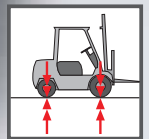

Fork-lift truck resistant



LongLife FloorMarking

A new developed product made of high quality plastic provided with a special glue. Resistant to folk-lift trucks and washes.

- immediate application
- washing and abrasion resistant
- not ruin the floor
- long durability

X Test its durability! Ask a test strip and place it on a very problematic spot.

SCRATCH-PROOF



Yellow/Black

White/Blue

White/Red

White/Black

ESD



ESD version

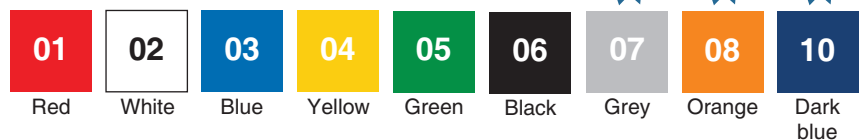

Application examples - LongLife FloorMarking



LongLife FloorMarking

ORGATEX® LongLife

LongLife FloorMarking, self-adhesive	Order-no. (+ Color code)	Color code	Width (mm)	Roll lenght (m)
Pack: roll in dispenser		01 02 03 04 05 06 07 08 10		
LG50-	01 02 03 04 05 06 07 08 10		50	50
LG75-	01 02 03 04 05 on request		75	50
LG100-	01 02 03 04 05 on request		100	50

LongLife FloorMarking, scratch-proof and ESD version, self-adhesive	Order-no. (+ Color code)	Color code	Width (mm)	Roll lenght (m)
Pack: roll in dispenser		SG BW RW SW ESD		
 Scratch-proof	LG50-	SG BW RW SW ESD	50	50
	LG75-	SG on request on request	75	50
	LG100-	SG on request on request	100	50

Floor marking

LongLife - 45° and 90° angles

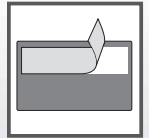
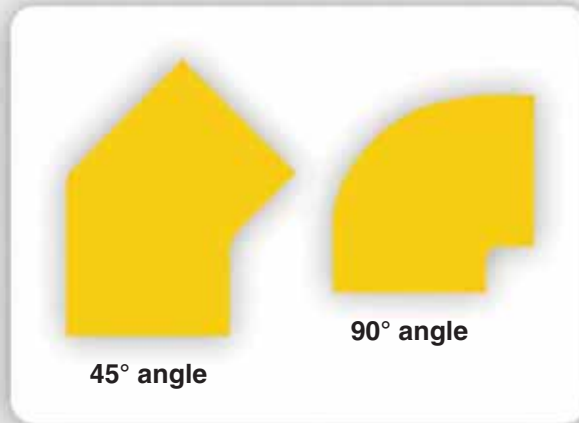

Self-adhesive



Easy to customize

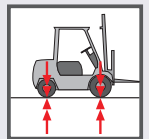

Fork-lift truck resistant

45° angle

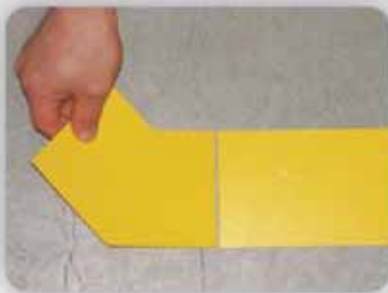

A

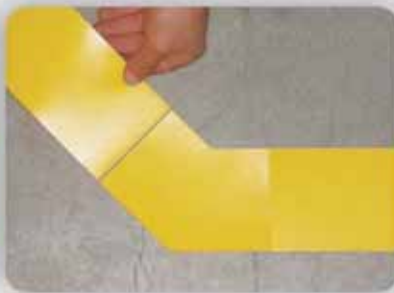

B

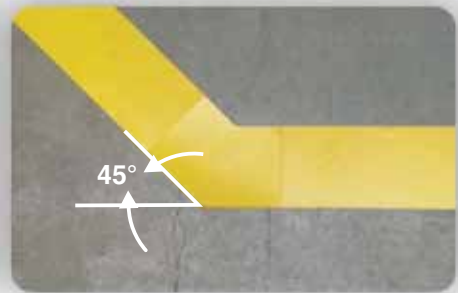

C

LongLife - 45° and 90° angles

Available in 2 versions.

For layout implementation of delimited areas.

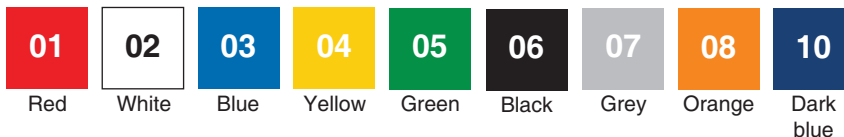

Application examples - LongLife - 45° and 90° angles



90° angle



(A)



(B)



(C)

Extra resistant



LongLife - 45° and 90° angles

ORGATEX® LongLife

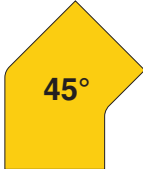
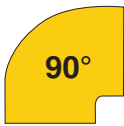
LongLife - 45° and 90° angles, self-adhesive	Order-no. (+ Color code)	Color code	Description	Size width/length (mm)
 		01 02 03 04 05 06 07 08 10		
	LG-50-W45-	01 02 03 04 05 on request	45° angle	50
	LG-75-W45-	01 02 03 04 05 on request	45° angle	75
	LG-100-W45-	01 02 03 04 05 on request	45° angle	100
	LG-50-W90-	01 02 03 04 05 on request	90° angle	50
	LG-75-W90-	01 02 03 04 05 on request	90° angle	75
	LG-100-W90-	01 02 03 04 05 on request	90° angle	100
				Pack = 50 pcs.

Floor marking

LongLife - Marking symbols

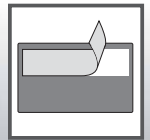

Self-adhesive

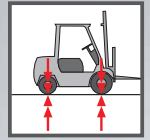

Fork-lift truck resistant

Length marking



T-piece



L-angle



Square

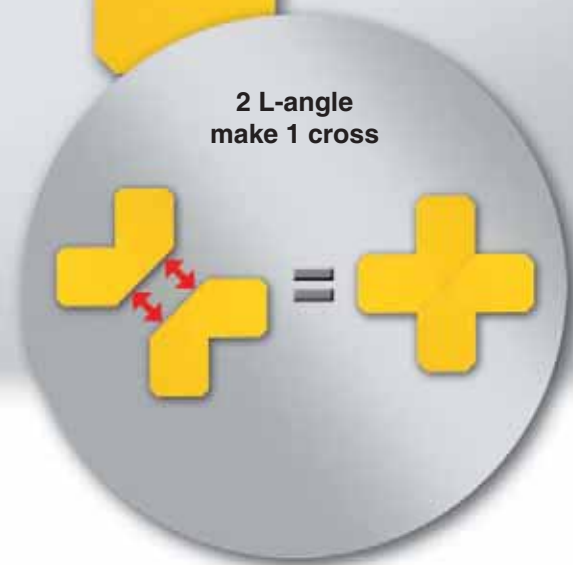

LongLife - Marking symbols

Available in 4 different formats.
Ideal for marking store areas.

The same duration of all LongLife products.

ORGATEX® LongLife

- Length marking
- T-piece
- L-angle
- Square

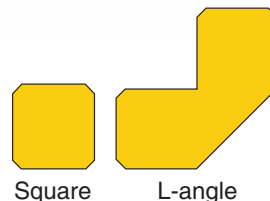

Square

L-angle

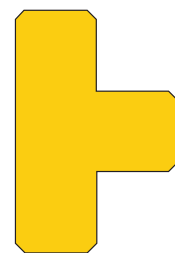

T-piece

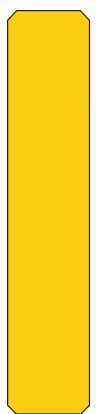

Length marking



01

Red



02

White



03

Blue



04

Yellow



05

Green



06

Black



07

Grey



08

Orange



10

Dark blue

Application examples - LongLife - Marking symbols

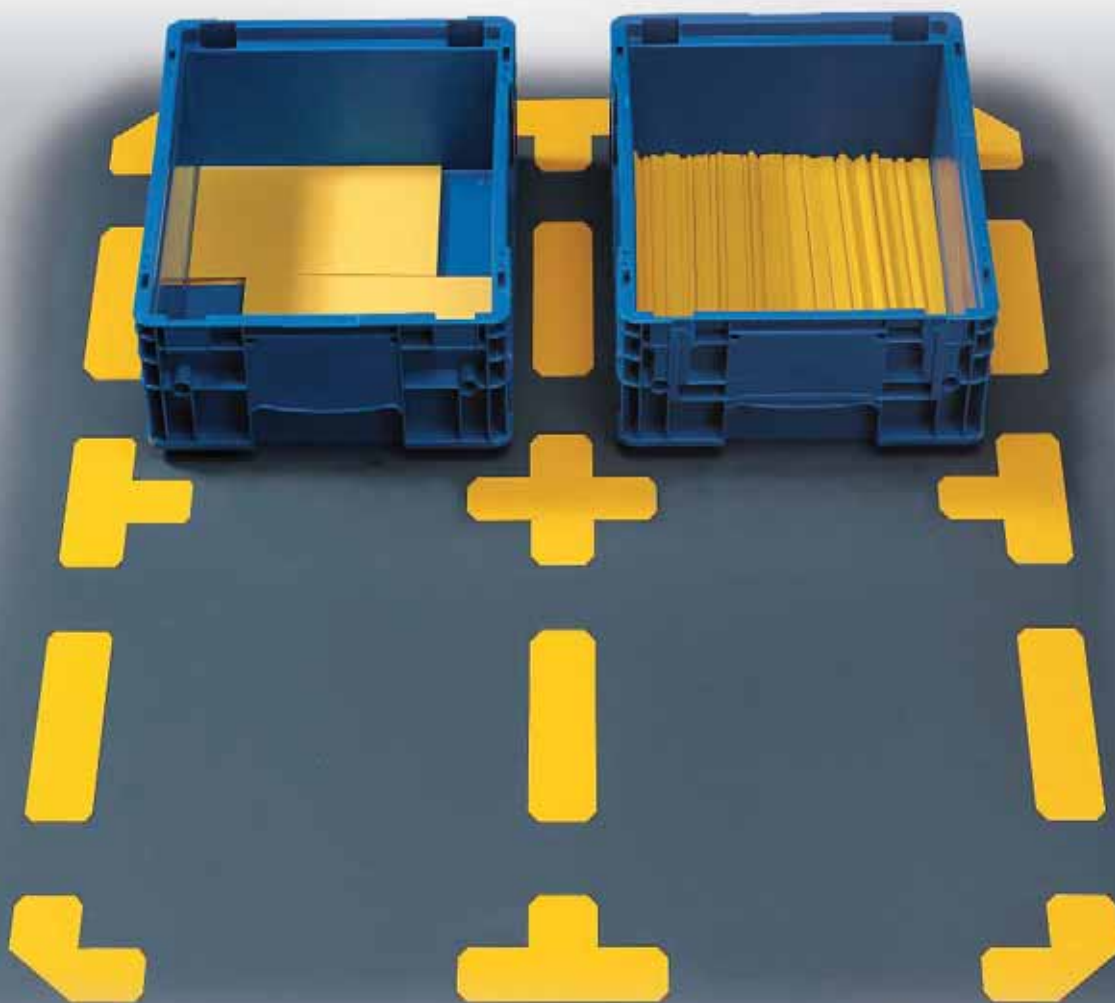

LongLife - Marking symbols

LongLife - Marking symbols, self-adhesive	Order-no. (+ Color code)	Color code										Description	Size width/length (mm)
		01	02	03	04	05	06	07	08	10			
<p>Square</p> <p>L-angle</p> <p>T-piece</p> <p>Length marking</p>	LG-50-T-	01	02	03	04	05	06	on request			T-piece	50	
	LG-75-T-	01	02	03	04	05	on request			T-piece	75		
	LG-50-L-	01	02	03	04	05	06	on request			L-angle	50	
	LG-75-L-	01	02	03	04	05	on request			L-angle	75		
	LG-50250-	01	02	03	04	05	06	on request			Length marking	50/250	
	LG-75350-	01	02	03	04	05	on request			Length marking	75/350		
	LG-100500-	01	02	03	04	05	on request			Length marking	100/500		
	LG-50-Q-	01	02	03	04	05	06	on request			Square	50	
	LG-75-Q-	01	02	03	04	05	on request			Square	75		
	LG-100-Q-	01	02	03	04	05	on request			Square	100		

Pack = 50 pcs.

Floor marking

LongLife Rounded - Marking symbols



Length marking

T-piece

L-angle

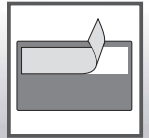

Self-adhesive

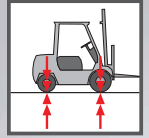

Fork-lift truck resistant



Circle



Cross

LongLife Rounded - Marking symbols

Available in 5 different formats.
Ideal for marking store areas.

The same duration of all LongLife products.

ORGATEX® LongLife Rounded

- Length marking
- Cross
- T-piece
- L-angle
- Circle

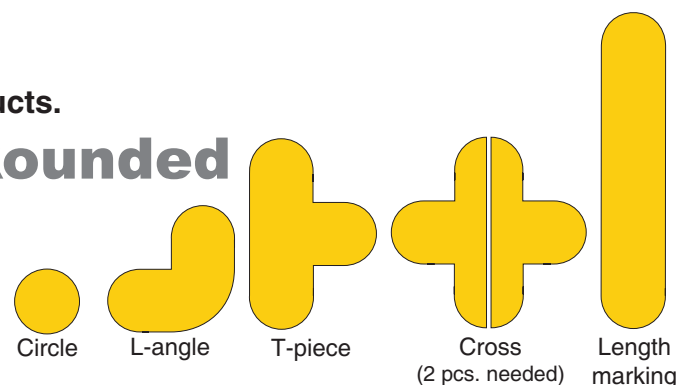

Red



White



Blue



Yellow



Green



06

Black



07

Grey



08

Orange



10

Dark blue

Application examples - LongLife Rounded - Marking symbols



LongLife Rounded - Marking symbols

LongLife Rounded - Marking symbols, self-adhesive	Order-no. (+ Color code)	Color code	Description	Size width/length (mm)
			01 02 03 04 05 06 07 08 10	
	LGR-90-T-	01 02 03 04 05 on request	T-piece	90
	LGR-90-L-	01 02 03 04 05 on request	L-angle	90
	LGR-90450-	01 02 03 04 05 on request	Length marking	90/450
	LGR-90-P-	01 02 03 04 05 on request	Circle	90
	LGR-90-K-	01 02 03 04 05 on request	Cross	90

Pack = 50 pcs.

Floor marking

LongLife - Protective screen

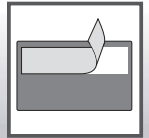

Self-adhesive



LongLife - Protective screen

Fast system to implement writing on the floor.

Available in different formats and colors.

The same duration of all LongLife products.

- easy to use
- washing and abrasion resistant
- long durability

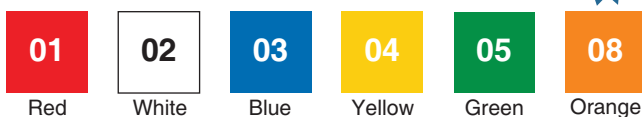

New

LEANPRODUCTS®

by

tecnogroup
componenti e sistemi per l'automazione



Tel. +39 0434 572757 • Fax. +39 0434 572750
info@LeanProducts.eu • www.LeanProducts.eu

Application examples - LongLife - Protective screen



LongLife - Protective screen

ORGATEX® LongLife

LongLife - Protective screen	Order-no. (+ Color code)	Color code	Width (mm)	Lenght (mm)	DIN format
		01 02 03 04 05 08			
DIN A4	LG-KL-A4-	01 02 03 04 05 08	400	310	DIN A4
DIN A5	LG-KL-1/2A4-	01 02 03 04 05 08	400	205	1/2 DIN A4
1/2 DIN A4	LG-KL-A5-	01 02 03 04 05 08	310	250	DIN A5
1/3 DIN	LG-KL-1/3DIN-	01 02 03 04 05 08	310	200	1/3 DIN A4
					Pack = 10 pcs.

Floor marking

Path and area classification symbols



Path and area classification symbols

Symbols ideal for LongLife - Protective screen DIN A4 to indicate specific paths or areas.

Available in different colors.

Ideal for classifying walking or forklift paths.

Available symbols:

- pedestrian
- forklift
- steps
- waste bin
- Custom on request with purchase of LongLife - Protective screen

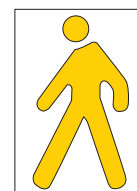

Pedestrian



Forklift

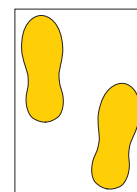

Steps



Waste bin



01
Red



02
White



03
Blue



04
Yellow



05
Green







06
Black

Application examples - Path and area classification symbols

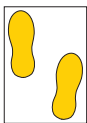

Path and area classification symbols

Path and area classification symbols	Order-no. (+ Color code)	Color code	Description	Width (mm)	Lenght (mm)	DIN format
		01 02 03 04 05 06				
 Pedestrian	PEDONE-	01 02 03 04 05 06	Pedestrian	210	297	DIN A4 compatible
 Forklift	MULETTO-	01 02 03 04 05 06	Forklift	297	210	DIN A4 compatible
 Steps	PASSI-	01 02 03 04 05 06	Steps	210	297	DIN A4 compatible
 Waste bin	CESTINO-	01 02 03 04 05 06	Waste bin	210	297	DIN A4 compatible

Pack = 10 pcs.

Floor marking

LongLife - Numbers and letters

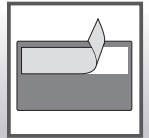

Self-adhesive



Scratch-proof

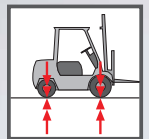

Fork-lift truck resistant

123 ABC

123 ABC

123456

LongLife - Numbers and letters

Very resistant product with scratch-proof treating.

Colors: grey background
black numbers / letters

Numbers height: 50 mm
75 mm
100 mm

Letters height: 50 mm
75 mm

Application examples - LongLife - Numbers and letters



LongLife - Numbers and letters

ORGATEX® LongLife

LongLife - Letters self-adhesive	Order-no.	Height (mm)	Colors
Change the letter in the order-no. with the one you chose: e.g. LG-B-50, LG-C-75, etc.	LG-A-50	50	Background: grey Letters: black
	LG-A-75	75	
Pack = 10 pcs.			

LongLife - Numbers self-adhesive	Order-no.	Height (mm)	Colors
Change the number in the order-no. with the one you chose: e.g. LG-1-50, LG-2-75, etc.	LG-0-50	50	Background: grey Numbers: black
	LG-0-75	75	
	LG-0-100	100	
Pack = 10 pcs.			

Floor marking

LongLife MODUL



MODUL without hole
extra strong self-adhesive

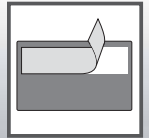

Self-adhesive



Scratch-proof

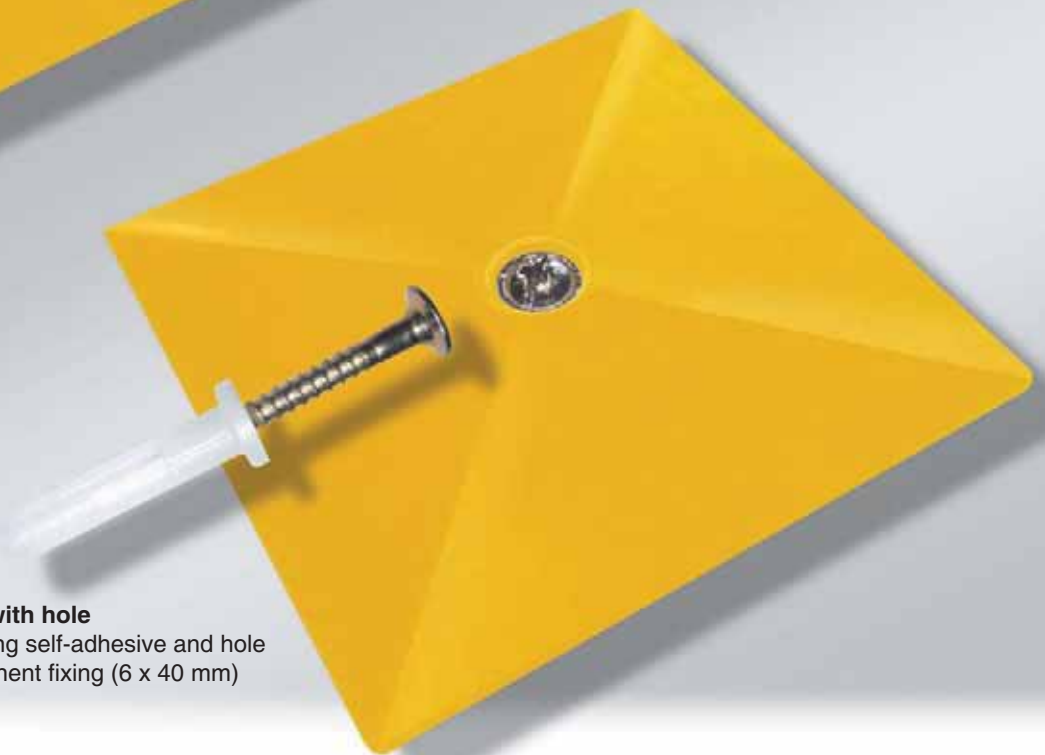

**EXTRA
STRONG**

MODUL with hole
extra strong self-adhesive and hole
for permanent fixing (6 x 40 mm)

LongLife MODUL

Extremely robust marking plates for heavy-load areas.



3 plates for L shape



4 plates for T shape



5 plates for cross shape

Use squares (75 x 75 mm) to easily assemble required shapes.

2 options available:

- a) extra strong self-adhesive
- b) extra strong self-adhesive and hole for permanent fixing (6 x 40 mm)



Red



White



Blue



Yellow



Green

Application examples - LongLife MODUL

Easy to handle - quick installation



Remove the protective film

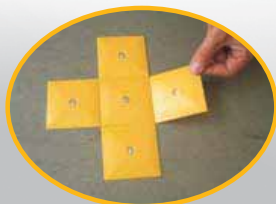

Apply



Perforate



Screw the plug



LongLife Modul handle pallets or skeleton boxes being pushed or pulled over them.

X Ask for some test samples!

LongLife MODUL

LongLife MODUL, self-adhesive	Order-no. (+ Color code)	Color code	Lenght (mm)	Width (mm)
		01 02 03 04 05		
	LGMOD-SK-	01 02 03 04 05	75	75

Pack = 50 pcs.

LongLife MODUL, self-adhesive + fixing hole	Order-no. (+ Color code)	Color code	Lenght (mm)	Width (mm)
		01 02 03 04 05		
	LGMOD-ND-	01 02 03 04 05	75	75
	LG6X40ND	Screw and plug 6 x 40 mm		

Pack = 50 pcs.